



**EurotestXD**  
**MI 3155**  
**Instruction manual**  
*Version 1.4.5, Code no. 20 752 716*

**Distributor:**

**Manufacturer:**

METREL d.d.  
Ljubljanska cesta 77  
1354 Horjul  
Slovenia  
web site: <http://www.metrel.si>  
e-mail: [metrel@metrel.si](mailto:metrel@metrel.si)



Mark on your equipment certifies that it meets requirements of all subjected EU regulations

© 2018 METREL

*The trade names Metrel<sup>®</sup>, Smartec<sup>®</sup>, Eurotest<sup>®</sup>, Auto Sequence<sup>®</sup> are trademarks registered in Europe and other countries.*

No part of this publication may be reproduced or utilized in any form or by any means without permission in writing from METREL.

## **i. About the instruction manual**

- › This Instruction manual contains detailed information on the EurotestXD, its key features, functionalities and use.
- › It is intended for technically qualified personnel responsible for the product and its use.
- › Please note that LCD screenshots in this document may differ from the actual instrument screens in details due to firmware variations and modifications.

# Table of Contents

<b>1</b>	<b>General description .....</b>	<b>8</b>
1.1	Warnings and notes .....	8
1.1.1	<i>Safety warnings</i> .....	8
1.1.2	<i>Markings on the instrument</i> .....	9
1.1.3	<i>Warnings related to safety of batteries</i> .....	9
1.1.4	<i>Warnings related to safety of measurement functions</i> .....	9
1.1.5	<i>Notes related to measurement functions</i> .....	10
1.2	Testing potential on PE terminal.....	13
1.3	Battery and charging of Li-ion battery pack .....	15
1.3.1	<i>Precharge</i> .....	16
1.3.2	<i>Li-ion battery pack guidelines</i> .....	18
1.4	Standards applied .....	19
<b>2</b>	<b>Instrument set and accessories.....</b>	<b>20</b>
2.1	Standard set MI 3155 EurotestXD .....	20
2.1.1	<i>Optional accessories</i> .....	20
<b>3</b>	<b>Instrument description .....</b>	<b>21</b>
3.1	Front panel.....	21
3.2	Connector panel.....	22
3.3	Back side .....	23
3.4	Carrying the instrument .....	25
3.4.1	<i>Secure attachment of the strap</i> .....	25
<b>4</b>	<b>Instrument operation .....</b>	<b>27</b>
4.1	General meaning of keys .....	27
4.2	General meaning of touch gestures.....	28
4.3	Virtual keyboard .....	29
4.4	Display and sound.....	30
4.4.1	<i>Terminal voltage monitor</i> .....	30
4.4.2	<i>Battery indication</i> .....	31
4.4.3	<i>Measurement actions and messages</i> .....	31
4.4.4	<i>Result indication</i> .....	33
4.4.5	<i>Auto Sequence® result indication</i> .....	33
4.5	Instruments main menu .....	34
4.6	General Settings .....	35
4.6.1	<i>Language</i> .....	36
4.6.2	<i>Power Save</i> .....	36
4.6.3	<i>Date and time</i> .....	37
4.6.4	<i>Workspace manager</i> .....	37
4.6.5	<i>Auto Sequences® groups</i> .....	37
4.6.6	<i>User accounts</i> .....	38
4.6.7	<i>Profiles</i> .....	42
4.6.8	<i>Settings</i> .....	42
4.6.9	<i>Devices</i> .....	44
4.6.10	<i>Initial Settings</i> .....	45
4.6.11	<i>About</i> .....	46
4.7	Instrument profiles.....	47
4.8	Workspace Manager .....	48
4.8.1	<i>Workspaces and Exports</i> .....	48

4.8.2	Workspace Manager main menu.....	48
4.8.3	Operations with Workspaces.....	49
4.8.4	Operations with Exports.....	49
4.8.5	Adding a new Workspace.....	51
4.8.6	Opening a Workspace.....	52
4.8.7	Deleting a Workspace / Export.....	52
4.8.8	Importing a Workspace.....	53
4.8.9	Exporting a Workspace.....	54
4.9	Auto Sequence® groups.....	55
4.9.1	Auto Sequence® groups menu.....	55
<b>5</b>	<b>Memory Organizer.....</b>	<b>57</b>
5.1	Memory Organizer menu.....	57
5.1.1	Measurement statuses.....	57
5.1.2	Structure Objects.....	58
5.1.3	Selecting an active Workspace in Memory Organizer.....	60
5.1.4	Adding Nodes in Memory Organizer.....	61
5.1.5	Operations in Tree menu.....	62
5.1.6	Searching in Memory Organizer.....	80
<b>6</b>	<b>Single tests.....</b>	<b>83</b>
6.1	Selection modes.....	83
6.1.1	Single test (measurement) screens.....	84
6.1.2	Setting parameters and limits of single tests.....	86
6.1.3	Single test start screen.....	87
6.1.4	Single test screen during test.....	88
6.1.5	Single test result screen.....	89
6.1.6	Editing graphs (Harmonics).....	91
6.1.7	Single test (inspection) screens.....	92
6.1.8	Help screens.....	96
6.1.9	Recall single test results screen.....	97
<b>7</b>	<b>Tests and measurements.....</b>	<b>98</b>
7.1	Voltage, frequency and phase sequence.....	98
7.2	R iso – Insulation resistance.....	102
7.3	R iso all – Insulation resistance.....	104
7.4	The DAR and PI diagnostic.....	106
7.5	Varistor test.....	108
7.6	R low – Resistance of earth connection and equipotential bonding.....	110
7.7	R low 4W.....	111
7.8	Continuity – Continuous resistance measurement with low current.....	113
7.8.1	Compensation of test leads resistance.....	114
7.9	Testing RCDs.....	116
7.9.1	RCD Uc – Contact voltage.....	117
7.9.2	RCD t – Trip-out time.....	119
7.9.3	RCD I – Trip-out current.....	119
7.10	RCD Auto – RCD Auto test.....	121
7.11	Z loop – Fault loop impedance and prospective fault current.....	124
7.12	Z loop 4W – Fault loop impedance and prospective fault current.....	127
7.13	Zs rcd – Fault loop impedance and prospective fault current in system with RCD ...	129
7.14	Z loop mΩ – High precision fault loop impedance and prospective fault current.....	132
7.15	Z line – Line impedance and prospective short-circuit current.....	135
7.16	Z line 4W – Line impedance and prospective short-circuit current.....	138
7.17	Z line mΩ – High precision line impedance and prospective short-circuit current ...	140
7.18	Voltage Drop.....	143

7.19	Z auto - Auto test sequence for fast line and loop testing .....	146
7.20	Earth – Earth resistance (3-wire test) .....	148
7.21	Earth 2 clamp – Contactless earthing resistance measurement (with two current clamps).....	150
7.22	Ro – Specific earth resistance.....	151
7.23	Power.....	153
7.24	Harmonics.....	155
7.25	Currents.....	157
7.26	ISFL – First fault leakage current.....	159
7.27	IMD – Testing of insulation monitoring devices.....	161
7.28	Rpe – PE conductor resistance .....	165
7.29	Illumination.....	167
7.30	Discharging time .....	168
7.31	AUTO TT – Auto test sequence for TT earthing system .....	171
7.32	AUTO TN (RCD) – Auto test sequence for TN earthing system with RCD.....	173
7.33	AUTO TN – Auto test sequence for TN earthing system without RCD.....	175
7.34	AUTO IT – Auto test sequence for IT earthing system.....	177
7.35	Locator.....	179
7.36	Visual and Functional inspections .....	181
<b>8</b>	<b>Auto Sequences®.....</b>	<b>182</b>
8.1	Selection of Auto Sequences®.....	182
8.1.1	<i>Selecting an active Auto Sequence® group in Auto Sequences® menu.....</i>	<i>182</i>
8.1.2	<i>Searching in Auto Sequences® menu.....</i>	<i>183</i>
8.1.3	<i>Organization of Auto Sequences® in Auto Sequences® menu .....</i>	<i>185</i>
8.2	Organization of an Auto Sequence® .....	185
8.2.1	<i>Auto Sequence® view menu .....</i>	<i>186</i>
8.2.2	<i>Step by step execution of Auto Sequences®.....</i>	<i>188</i>
8.2.3	<i>Auto Sequence® result screen.....</i>	<i>190</i>
8.2.4	<i>Auto Sequence® memory screen.....</i>	<i>191</i>
<b>9</b>	<b>Communication.....</b>	<b>193</b>
9.1	USB and RS232 communication .....	193
9.2	Bluetooth communication .....	193
9.3	Bluetooth and RS-232 communication with scanners.....	194
<b>10</b>	<b>Upgrading the instrument .....</b>	<b>195</b>
<b>11</b>	<b>Maintenance.....</b>	<b>196</b>
11.1	Fuse replacement .....	196
11.2	Battery pack insertion / replacement .....	197
11.3	Cleaning.....	198
11.4	Periodic calibration.....	198
11.5	Service.....	198
<b>12</b>	<b>Technical specifications.....</b>	<b>199</b>
12.1	R iso, R iso all – Insulation resistance .....	199
12.2	Diagnostic test.....	200
12.3	R low, R low 4W – Resistance of earth connection and equipotential bonding .....	200
12.4	Continuity – Continuous resistance measurement with low current .....	201
12.5	RCD testing.....	201
12.5.1	<i>General data.....</i>	<i>201</i>
12.5.2	<i>RCD Uc – Contact voltage.....</i>	<i>202</i>
12.5.3	<i>RCD t – Trip-out time.....</i>	<i>202</i>
12.5.4	<i>RCD I – Trip-out current .....</i>	<i>203</i>
12.5.5	<i>RCD Auto.....</i>	<i>203</i>

12.6	Z loop, Z loop 4W – Fault loop impedance and prospective fault current.....	204
12.7	Zs rcd – Fault loop impedance and prospective fault current in system with RCD ...	205
12.8	Z loop mΩ – High precision fault loop impedance and prospective fault current .....	205
12.9	Z line, Z line 4W – Line impedance and prospective short-circuit current .....	206
12.10	Voltage Drop .....	206
12.11	Z line mΩ – High precision line impedance and prospective fault current .....	207
12.12	Z auto, AUTO TT, AUTO TN, AUTO TN (RCD), AUTO IT .....	207
12.13	Rpe – PE conductor resistance .....	207
12.14	Earth – Earth resistance (3-wire measurement) .....	208
12.15	Earth 2 clamp – Contactless earthing resistance measurement (with two current clamps) .....	208
12.16	Ro – Specific earth resistance .....	209
12.17	Voltage, frequency, and phase rotation .....	210
12.17.1	Phase rotation .....	210
12.17.2	Voltage / Online terminal voltage monitor .....	210
12.17.3	Frequency .....	210
12.18	Varistor test .....	211
12.19	Currents .....	212
12.20	Power.....	213
12.21	Harmonics.....	213
12.22	ISFL – First fault leakage current.....	214
12.23	IMD .....	214
12.24	Illumination .....	214
12.25	Discharging time .....	215
12.26	Auto Sequences® .....	215
12.27	General data .....	215
<b>Appendix A</b>	<b>Profile notes.....</b>	<b>217</b>
A.1	Profile Austria (ATAF) .....	217
A.2	Profile Hungary (ATAG) .....	218
A.3	Profile Finland (ATAH) .....	219
A.4	Profile France (ATAI).....	220
A.5	Profile Switzerland (ATAJ).....	220
<b>Appendix B</b>	<b>Commanders (A 1314, A 1401).....</b>	<b>221</b>
B.1	 Warnings related to safety .....	221
B.2	Battery.....	221
B.3	Description of commanders.....	221
B.4	Operation of commanders.....	222
<b>Appendix C</b>	<b>Locator receiver R10K.....</b>	<b>223</b>
<b>Appendix D</b>	<b>Structure objects .....</b>	<b>224</b>
<b>Appendix E</b>	<b>Default list of Auto Sequences® .....</b>	<b>227</b>
<b>Appendix F</b>	<b>Programming of Auto Sequences® on Metrel ES Manager.....</b>	<b>228</b>
F.1	Auto Sequence® Editor workspace.....	228
F.2	Managing groups of Auto Sequences® .....	229
F.3	Auto Sequence® Name, Description and Image editing .....	232
F.4	Search within selected Auto Sequence® group.....	233
F.5	Elements of an Auto Sequence® .....	234
F.5.1	Auto Sequence® steps .....	234
F.5.2	Single tests.....	234
F.5.3	Flow commands .....	234
F.5.4	Number of measurement steps.....	234

F.6	Creating / modifying an Auto Sequence®.....	235
F.7	Description of flow commands.....	236
F.8	Custom Inspections programming.....	238
F.8.1	<i>Creating and editing Custom Inspections</i> .....	238
F.8.2	<i>Applying Custom Inspections</i> .....	240



# 1 General description

## 1.1 Warnings and notes



### 1.1.1 Safety warnings

In order to reach high level of operator safety while carrying out various measurements using the EurotestXD instrument, as well as to keep the test equipment undamaged, it is necessary to consider the following general warnings:

- › **Read this user manual carefully, otherwise the use of the instrument may be dangerous for the operator, the instrument or for the equipment under test!**
- › **Consider warning markings on the instrument (see next chapter for more information).**
- › **If the test equipment is used in a manner not specified in this user manual, the protection provided by the equipment could be impaired!**
- › **Do not use the instrument or any of the accessories if any damage is noticed!**
- › **Regularly check the instrument and accessories for correct functioning to avoid hazard that could occur from misleading results.**
- › **Regularly check the instrument and accessories for correct functioning to avoid hazard that could occur from misleading results.**
- › **Consider all generally known precautions in order to avoid risk of electric shock while dealing with hazardous voltages!**
- › **Always check for the presence of dangerous voltage on PE test terminal of installation by touching the TEST key on the instrument or by any other method before starting single test and Auto Sequence® measurements. Make sure that the TEST key is grounded through human body resistance without any insulated material between (gloves, shoes, insulated floors, pens,...). PE test could otherwise be impaired and results of a single test or Auto Sequence® can mislead. Even detected dangerous voltage on PE test terminal cannot prevent running of a single test or Auto Sequence®. All such behaviour is regarded as misuse. Operator of the instrument must stop the activity immediately and eliminate the fault/connection problem before proceeding with any activity!**
- › **Use only standard or optional test accessories supplied by your distributor!**
- › **In case a fuse has blown follow the instructions in this manual in order to replace it! Use only fuses that are specified!**
- › **Service, calibration or adjustment of instruments and accessories is only allowed to be carried out by a competent authorized person!**
- › **Do not use the instrument in AC supply systems with voltages higher than 550 V.a.c.**
- › **Consider that protection category of some accessories is lower than of the instrument. Test tips and Tip commander have removable caps. If they are removed the protection falls to CAT II. Check markings on accessories!**
  - **cap off, 18 mm tip: CAT II up to 1000 V**
  - **cap on, 4 mm tip: CAT II 1000 V / CAT III 600 V / CAT IV 300 V**

- › The instrument comes supplied with rechargeable Li-Ion battery pack. The battery pack should only be replaced with the same type as defined on the battery compartment label or as described in this manual!
- › Hazardous voltages exist inside the instrument. Disconnect all test leads, remove the power supply cable and switch off the instrument before removing battery /fuse compartment cover.
- › Do not connect any voltage source on C1 inputs. It is intended only for connection of current clamps. Maximal input voltage is 3 V!

### 1.1.2 Markings on the instrument

- ›  Read the Instruction manual with special care to safety operation«. The symbol requires an action!



- › Do not use the instrument in AC supply systems with voltages higher than 550 Va.c.!

- ›  Mark on your equipment certifies that it meets requirements of all subjected EU regulations.



- › This equipment should be recycled as electronic waste.

### 1.1.3 Warnings related to safety of batteries

- › Use only batteries and power supply adapter delivered from the manufacturer or distributor of the test equipment.
- › Never dispose of the batteries in a fire as it may cause them to explode or generate a toxic gas.
- › Do not attempt to disassemble, crush or puncture the batteries in any way.
- › Do not short circuit or reverse polarity the external contacts on a battery.
- › Avoid exposing the battery to excessive shock/impacts or vibration.
- › Do not use a damaged battery.
- › The Li – ion battery contains safety and protection circuit, which if damaged, may cause the battery to generate heat, rupture or ignite.
- › Do not leave a battery on prolonged charge when not in use.
- › If a battery has leaking fluids, do not touch any fluids.
- › In case of eye contact with fluid, do not rub eyes. Immediately flush eyes thoroughly with water for at least 15 minutes, lifting upper and lower lids, until no evidence of the fluid remains. Seek medical attention.

### 1.1.4 Warnings related to safety of measurement functions

#### Insulation resistance (R iso, R iso – all)

- › Insulation resistance measurement should only be performed on de-energized objects!
- › Do not touch the test object during the measurement or before it is fully discharged! Risk of electric shock!

#### Continuity functions (R low, R low 4W, Continuity)

- › Continuity measurements should only be performed on de-energized objects!

## 1.1.5 Notes related to measurement functions

### Insulation resistance (R iso, R iso – all)

- › The measuring range is decreased if using Tip commander A 1401.
- › If a voltage of higher than 30 V (AC or DC) is detected between test terminals, the measurement will not be performed.

### Diagnostic test

- › If any insulation resistance values ( $R_{ISO}(15\text{ s})$  or  $R_{ISO}(60\text{ s})$ ) are over-ranged the **DAR** factor is not calculated. The result field is blank: DAR: \_\_\_\_\_!
- › If any insulation resistance values ( $R_{ISO}(60\text{ s})$  or  $R_{ISO}(10\text{ min})$ ) are over-ranged the **PI** factor is not calculated. The result field is blank: PI : \_\_\_\_\_!

### Continuity functions (R low, R low 4W, Continuity)

- › If a voltage of higher than 10 V (AC or DC) is detected between test terminals, the measurement will not be performed.
- › Parallel loops may influence on test results.

### Earth, Earth 2 clamp, Ro

- › If voltage between test terminals is higher than 10 V (Earth, Earth 2 clamps) or 30 V (Ro) the measurement will not be performed.
- › Contactless earthing resistance measurement (using two current clamps) enables simple testing of individual earthing rods in large earthing system. It is especially suitable for use in urban areas because there is usually no possibility to place the test probes.
- › For two clamps earth resistance measurement clamps A 1018 and A 1019 should be used. Clamps A 1391 are not supported. The distance between clamps should be at least 30 cm.
- › For specific earth resistance measurements  $\rho$  Adaptor A 1199 should be used.

### RCD t, RCD I, RCD Uc, RCD Auto

- › Parameters set in one function are also kept for other RCD functions!
- › Selective (time-delayed) RCDs have delayed response characteristics. As the contact voltage pre-test or other RCD tests influence the time delayed RCD it takes a certain period to recover into normal state. Therefore a time delay of 30 s is inserted before performing trip-out test by default.
- › Portable RCDs (PRCD, PRCD-K and PRCD-S) are tested as general (non-delayed) RCDs. Trip-out times, trip-out currents and contact voltage limits are equal to limits of general (non-delayed) RCDs.
- › The a.c. part of MI and EV RCDs is tested as general (non-delayed) RCDs.
- › The d.c. part of MI and EV RCDs is tested with a d. c. test current The Pass limit is between 0.5 and 1.0  $I_{dNDC}$ .
- › The Zs rcd function takes longer to complete but offers much better accuracy of fault loop resistance (in comparison to the  $R_L$  sub-result in Contact voltage function).
- › Auto test is finished without x5 tests in case of testing the RCD types A, F, B and B+ with rated residual currents of  $I_{dN} = 300\text{ mA}$ , 500 mA, and 1000 mA or testing the RCD type AC with rated residual current of  $I_{dN} = 1000\text{ mA}$ . In this case Auto test result passes if all other results pass, and indications for x5 are omitted.
- › Auto test is finished without x1 tests in case of testing the RCD types B and B+ with rated residual currents of  $I_{dN} = 1000\text{ mA}$ . In this case Auto test result passes if all other results pass, and indications for x1 are omitted.
- › Tests for sensitivity  $I_{dn}(+)$  and  $I_{dn}(-)$  are omitted for selective type RCD.
- › Trip out time measurement for B and B+ type RCDs in AUTO function is made with sine-wave test current, while trip-out current measurement is made with DC test current.

**Z loop, Zloop 4W, Zs rcd**

- The specified accuracy of tested parameters is valid only if the mains voltage is stable during the measurement.
- The measurement accuracy and immunity against noise are higher if **I test** parameter in Zsrcd is set to 'Standard'.
- Fault loop impedance (Z loop) measurements will trip an RCD.
- The Zs rcd measurement does not normally trip an RCD. However if a leakage current from L to PE already flows or if a very sensitive RCD is installed (for example EV type) the RCD could trip. In this case setting parameter **I test** to 'Low' can help.

**Z line, Z line 4W, Voltage drop**

- In case of measurement of  $Z_{\text{Line-Line}}$  with the instrument test leads PE and N connected together the instrument will display a warning of dangerous PE voltage. The measurement will be performed anyway.
- Specified accuracy of tested parameters is valid only if mains voltage is stable during the measurement.
- If the reference impedance is not set the value of  $Z_{\text{REF}}$  is considered as  $0.00 \Omega$ .
- The lowest value of Zref, measured at different settings of the **Test** or **Phase** parameters is used for Voltage drop ( $\Delta U$ ) measurement in Voltage drop single test, Zauto single test, auto tests and Auto Sequences®.
- Measuring Zref without test voltage present (disconnected test leads) will reset Zref value to initial value.

**Power, Harmonics, Currents**

- Consider polarity of current clamp (arrow on test clamp should be oriented toward connected load), otherwise result will be negative!

**Illumination**

- LUXmeter type B (A 1172) and LUXmeter type C (A 1173) probes are supported by the instrument.
- Artificial light sources reach full power of operation after a period of time (see technical data for light sources) and should be therefore switched on for this period of time before the measurements are taken.
- For accurate measurement make sure that the milk glass bulb is lit without any shadows cast by hand, body or other unwanted objects.
- Refer to the Illuminance handbook for more information.

**Rpe**

- The specified accuracy of tested parameters is valid only if the mains voltage is stable during the measurement.
- Measurement will trip an RCD if the parameter RCD is set to 'No'.
- The measurement does not normally trip an RCD if the parameter RCD is set to 'Yes'. However, the RCD can trip if a leakage current from L to PE already flows.

**IMD**

- It is recommended to disconnect all appliances from the tested supply to receive regular test results. Any connected appliance will influence the insulation resistance threshold test.

**Z line mΩ, Z loop mΩ**

- A 1143 Euro Z 290 A adapter is required for this measurements.

**AutoTT, Auto TN(RCD), Auto TN, Auto IT, Zauto**

- › Voltage drop (dU) measurement in each Auto test (except Z auto) is enabled only if  $Z_{REF}$  is set.
- › See notes related to Zline, Zloop, Zs rcd, Voltage drop, Rpe, IMD and ISFL single tests.

**Auto Sequences®**

- › Metrel Auto Sequences® are designed as guidance to tests in order to significantly reduce testing time, improve work scope and increase traceability of the tests performed. METREL assumes no responsibility for any Auto Sequence® by any means. It is the user's responsibility, to check adequacy for the purpose of use of the selected Auto Sequence®. This includes type and number of tests, sequence flow, test parameters and limits.
- › Auto Sequences® mode allows building custom-defined test sequences.
- › See notes related to single tests in the selected Auto Sequence®.
- › Compensate test leads resistance before entering Auto Sequences®.
- › Zref value for Voltage drop test ( $\Delta U$ ) implemented in any Auto Sequence® should be set in single test function.

## 1.2 Testing potential on PE terminal

In certain instances faults on the installation's PE wire or any other accessible metal bonding parts can become exposed to live voltage. This is a very dangerous situation since the parts connected to the earthing system are considered to be free of potential. In order to properly

check the installation against this fault the  key should be used as an indicator prior to performing live tests.

### Examples for application of PE test terminal

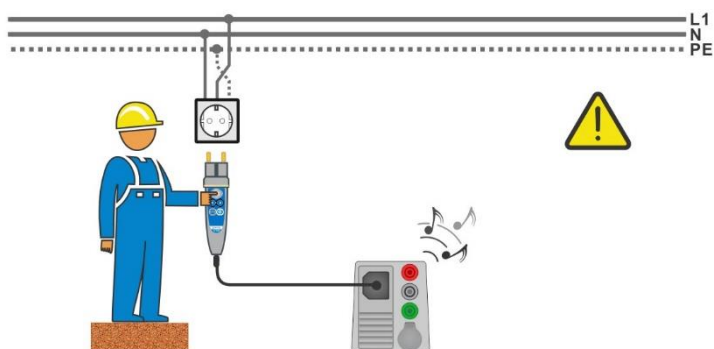

Figure 1.1: Reversed L and PE conductors (plug commander)

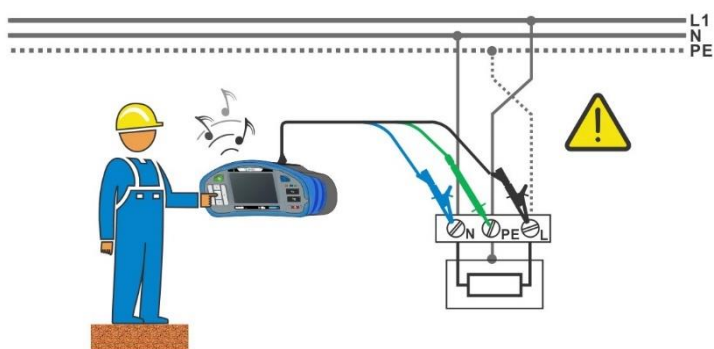



Figure 1.2: Reversed L and PE conductors (application of 3-wire test lead)

### Warning!



**Reversed phase and protection conductors! The most dangerous situation!**  
 If dangerous voltage is detected on the tested PE terminal, stop all measurements immediately and ensure the cause of the fault is eliminated before proceeding with any activity!

## Test procedure

- 
- › Connect test cable to the instrument.
  - › Connect test leads to the object under test, see **Figure 1.1** and **Figure 1.2**.
- 
- › Touch  test probe for at least 1 second.  
If PE terminal is connected to phase voltage the warning message is displayed, display is yellow coloured, instrument buzzer is activated and further measurements are disabled: RCD tests, Z loop, Zs rcd, Z auto, AUTO TT, AUTO TN, AUTO TN (rcd) and Auto Sequences®.
- 

## Notes:

- › PE test terminal is active in the Voltage, Rpe, RCD tests, Z loop, Zs rcd, Z auto, Z line,  $\Delta U$ , AUTO TT, AUTO TN, AUTO TN (rcd), AUTO IT tests and Auto Sequences® only!
- › In case of detection of phase voltage on PE terminal in IT earthing system, the tests can be enabled/disabled according to setting of parameter 'Ignore PE probe warning (IT)'.
- › For correct testing of PE terminal, the  key has to be touched for at least 1 second.
- › Make sure that the TEST key is grounded through human body resistance without any insulated material between (gloves, shoes, insulated floors, pens, ...). PE test could otherwise be impaired and results of a single test or Auto Sequence® can mislead. Even detected dangerous voltage on PE test terminal cannot prevent running of a single test or Auto Sequence®. All such behaviour is regarded as misuse. Operator of the instrument must stop the activity immediately and eliminate the fault/connection problem before proceeding with any activity!

### 1.3 Battery and charging of Li-ion battery pack

The instrument is designed to be powered by rechargeable Li-ion battery pack. The LCD contains an indication of battery condition (upper right section of LCD). In case the battery is too weak the instrument indicates this as shown in **Figure 1.3**.

Symbol:

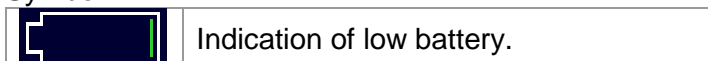

**Figure 1.3: Battery test**

The battery is charged whenever the power supply is connected to the instrument. The charger socket polarity is shown in **Figure 1.4**. Internal circuit controls (CC, CV) charging and assures maximum battery lifetime. Nominal operating time is declared for battery with nominal capacity of 4.4 Ah.



**Figure 1.4: Charger socket polarity**

The instrument automatically recognizes the connected power supply and begins charging.

Symbol:

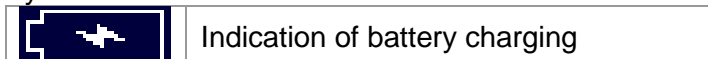
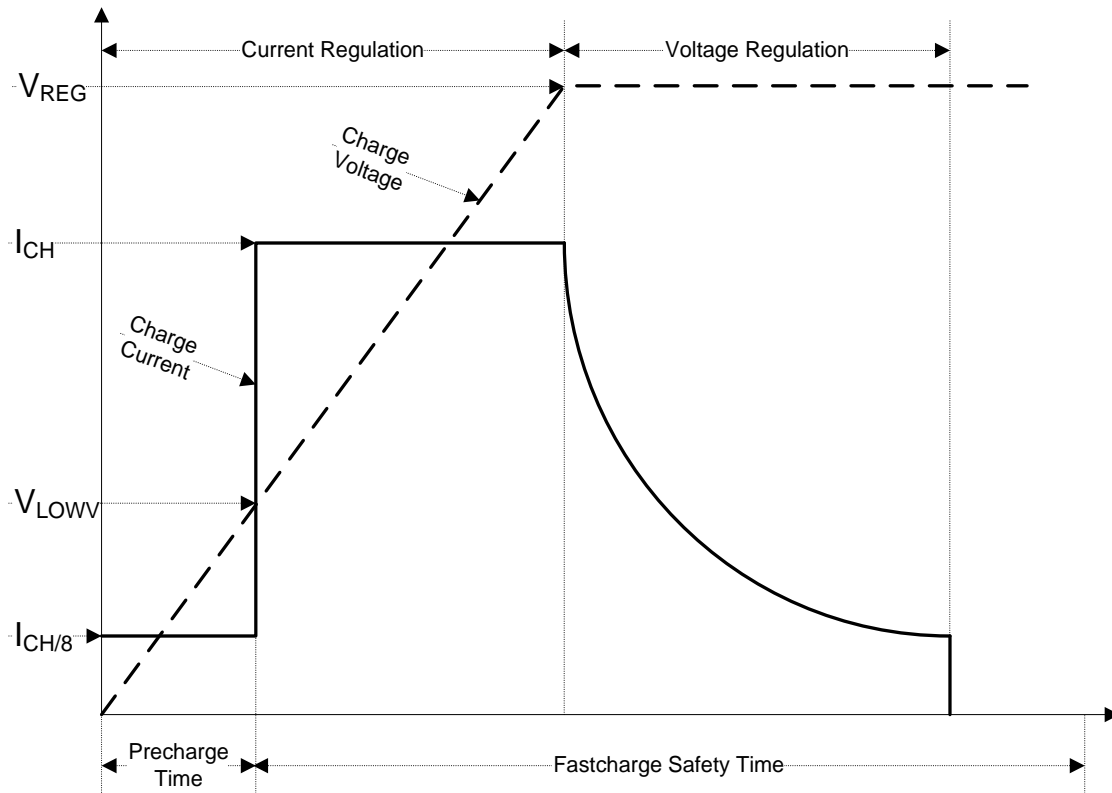

**Figure 1.5: Charging indication (animation)**

Battery and charging characteristic	Typical
Battery types	18650T22A2S2P 18650T22A2S4P (optional)
Charging mode	CC / CV
Nominal voltage	7,2 V
Rated capacity	4400 mAh (type: 18650T22A2S2P) 8800 mAh (type: 18650T22A2S4P)
Max charging voltage	8,0 V
Max charging current	2,2 A (type: 18650T22A2S2P) 3,0 A (type: 18650T22A2S4P)
Max discharge current	2,5 A
Typical charging time	3 hours (type: 18650T22A2S2P) 4,5 hours (type: 18650T22A2S4P)



Typical charging profile which is also used in this instrument is shown in **Figure 1.6**.



**Figure 1.6: Typical charging profile**

where:

- $V_{REG}$  ..... Battery charging voltage
- $V_{LOWV}$  ..... Precharge threshold voltage
- $I_{CH}$  ..... Battery charging current
- $I_{CH/8}$  ..... 1/8 of the charging current

### 1.3.1 Precharge

On power up, if the battery voltage is below the  $V_{LOWV}$  threshold, the charger applies 1/8 of the charging current to the battery. The precharge feature is intended to revive deeply discharged battery. If the  $V_{LOWV}$  threshold is not reached within 30 minutes of initiating precharge, the charger turns off and a FAULT is indicated.



**Figure 1.7: Battery fault indication (charging suspended, timer fault, battery absent)**



**Figure 1.8: Battery full indication (charging completed)**

**Note:**

- As a safety backup, the charger also provides an internal 5-hour charge timer for fast charge.

Typical charging time is 3 hours (Battery type: 18650T22A2S2P) in the temperature range of 5°C to 60°C.

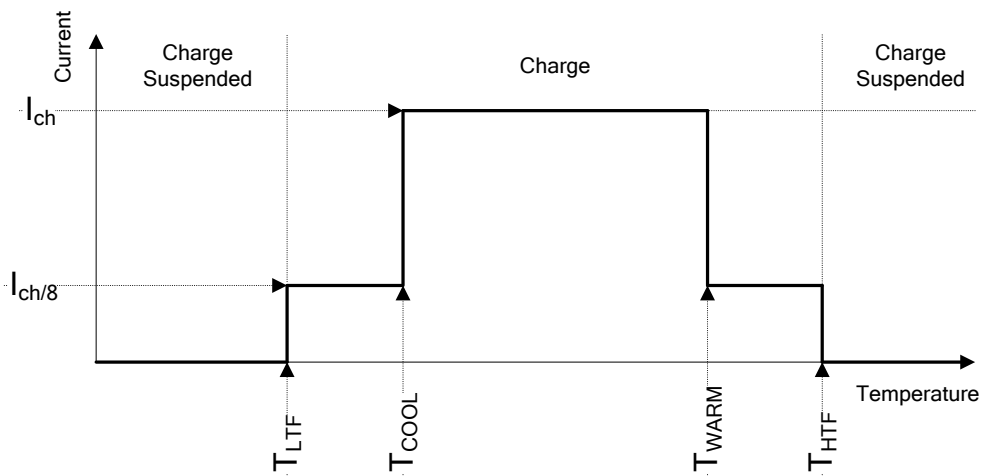

Figure 1.9: Typical charging current vs temperature profile

where:

- $T_{LTF}$  ..... Cold temperature threshold (typ. -15°C)
- $T_{COOL}$  ..... Cool temperature threshold (typ. 0°C)
- $T_{WARM}$  ..... Warm temperature threshold (typ. +60°C)
- $T_{HTF}$  ..... Hot temperature threshold (typ. +75°C)

The charger continuously monitors battery temperature. To initiate a charge cycle, the battery temperature must be within the  $T_{LTF}$  to  $T_{HTF}$  thresholds. If battery temperature is outside of this range, the controller suspends charge and waits until the battery temperature is within the  $T_{LTF}$  to  $T_{HTF}$  range.

If the battery temperature is between the  $T_{LTF}$  and  $T_{COOL}$  thresholds or between the  $T_{WARM}$  and  $T_{HTW}$  thresholds, charge is automatically reduced to  $I_{CH/8}$  (1/8 of the charging current).

### 1.3.2 Li – ion battery pack guidelines

Li – ion rechargeable battery pack requires routine maintenance and care in their use and handling. Read and follow the guidelines in this Instruction manual to safely use Li – ion battery pack and achieve the maximum battery life cycles.

Do not leave batteries unused for extended periods of time – more than 6 months (self – discharge).

When a battery has been unused for 6 months, check the charge status see chapter **4.4.2 Battery indication**. Rechargeable Li – ion battery pack has a limited life and will gradually lose their capacity to hold a charge. As the battery loses capacity, the length of time it will power the product decreases.

#### **Storage**

- › Charge or discharge the instruments battery pack to approximately 50 % of capacity before storage.
- › Charge the instrument battery pack to approximately 50 % of capacity at least once every 6 months.

#### **Transportation**

- › Always check all applicable local, national, and international regulations before transporting a Li – ion battery pack.



#### **Handling Warnings**

- › **Do not disassemble, crush, or puncture a battery in any way.**
- › **Do not short circuit or reverse polarity the external contacts on a battery.**
- › **Do not dispose of a battery in fire or water.**
- › **Avoid exposing the battery to excessive shock/impacts or vibration.**
- › **Do not use a damaged battery.**
- › **The Li – ion battery contains safety and protection circuit, which if damaged, may cause the battery to generate heat, rupture or ignite.**
- › **Do not leave a battery on prolonged charge when not in use.**
- › **If a battery has leaking fluids, do not touch any fluids.**
- › **In case of eye contact with fluid, do not rub eyes. Immediately flush eyes thoroughly with water for at least 15 minutes, lifting upper and lower lids, until no evidence of the fluid remains. Seek medical attention.**

## 1.4 Standards applied

The EurotestXD instruments are manufactured and tested in accordance with the following regulations:

---

### **Electromagnetic compatibility (EMC)**

EN 61326-1 Electrical equipment for measurement, control and laboratory use – EMC requirements  
Class B (Hand-held equipment used in controlled EM environments)

---

### **Safety (LVD)**

EN 61010-1 Safety requirements for electrical equipment for measurement, control and laboratory use – Part 1: General requirements  
EN 61010-2-030 Safety requirements for electrical equipment for measurement, control and laboratory use – Part 2-030: Particular requirements for testing and measuring circuits  
EN 61010-031 Safety requirements for electrical equipment for measurement, control and laboratory use – Part 031: Safety requirements for hand-held probe assemblies for electrical measurement and test  
EN 61010-2-032 Safety requirements for electrical equipment for measurement, control, and laboratory use - Part 2-032: Particular requirements for hand-held and hand-manipulated current sensors for electrical test and measurement

---

### **Functionality**

EN 61557 Electrical safety in low voltage distribution systems up to 1000 V<sub>AC</sub> and 1500 V<sub>AC</sub> – Equipment for testing, measuring or monitoring of protective measures  
Part 1: General requirements  
Part 2: Insulation resistance  
Part 3: Loop resistance  
Part 4: Resistance of earth connection and equipotential bonding  
Part 5: Resistance to earth  
Part 6: Residual current devices (RCDs) in TT and TN systems  
Part 7: Phase sequence  
Part 10: Combined measuring equipment  
Part 12: Performance measuring and monitoring devices (PMD)  
Part 14: Equipment for testing the safety of electrical equipment for machinery  
DIN 5032 Photometry  
Part 7: Classification of illuminance meters and luminance meters

---

### **Reference standards for electrical installations and components**

EN 61008 Residual current operated circuit-breakers without integral overcurrent protection for household and similar uses  
EN 61009 Residual current operated circuit-breakers with integral overcurrent protection for household and similar uses  
IEC 60364-4-41 Electrical installations of buildings Part 4-41 Protection for safety – protection against electric shock  
BS 7671 IEE Wiring Regulations (17<sup>th</sup> edition)  
AS/NZS 3017 Electrical installations – Verification guidelines

---

## 2 Instrument set and accessories

### 2.1 Standard set MI 3155 EurotestXD

- › Instrument MI 3155 EurotestXD
- › Soft carrying bag
- › Set of carrying straps
- › Earth set, 3-wire, 20 m
- › Plug commander, 1.5 m + 2 batteries, size AAA
- › 3-wire test lead, 3 x 1.5 m
- › 4-wire test lead, 4 x 1.5 m
- › 2.5 kV test lead, 2 x 1.5 m
- › Test probe, 4 pcs (black, blue, green, red)
- › Crocodile clip, 6 pcs (black × 2, blue, green, red × 2)
- › Current clamp 1000:1
- › Current clamp (low range, leakage)
- › RS232-PS/2 cable
- › USB cable
- › Li-ion battery pack, 7.2 V , 4400 mAh (Type: 18650T22A2S2P)
- › Power supply adapter 12 V, 3 A (Type: CGSW-1203000)
- › CD includes:
  - PC software Metrel ES Manager
  - Instruction manual
  - "Guide for testing and verification of low voltage installations" handbook
- › Quick guide
- › Calibration Certificate

#### 2.1.1 Optional accessories

See the attached sheet for a list of optional accessories that are available on request from your distributor.

## 3 Instrument description

### 3.1 Front panel



Figure 3.1: Front panel

1	<b>4,3" COLOR TFT DISPLAY WITH TOUCH SCREEN</b>
2	<b>SAVE key</b> Stores actual measurement result(s)
3	<b>CURSOR keys</b> Navigate in menus
4	<b>RUN key</b> Start / stop selected measurement. Enter selected menu or option. View available values for selected parameter / limit.
5	<b>ON / OFF key</b> Switch instrument on / off. The instrument automatically switches off after 10 minutes of idle state (no key pressed or any touchscreen activity) Press and hold the key for 5 s to switch off the instrument.
6	<b>GENERAL SETTINGS key</b> Enter General settings menu.
7	<b>OPTIONS key</b> Show detailed view of options.
8	<b>MEMORY ORGANIZER shortcut key</b> Shortcut key to enter Memory organizer menu.
9	<b>SINGLE TESTS shortcut key</b> Shortcut key to enter Single Tests menu.
10	<b>AUTO SEQUENCES® shortcut key</b> Shortcut key to enter Auto Sequences® menu.
11	<b>ESC key</b> Back to previous menu.

### 3.2 Connector panel

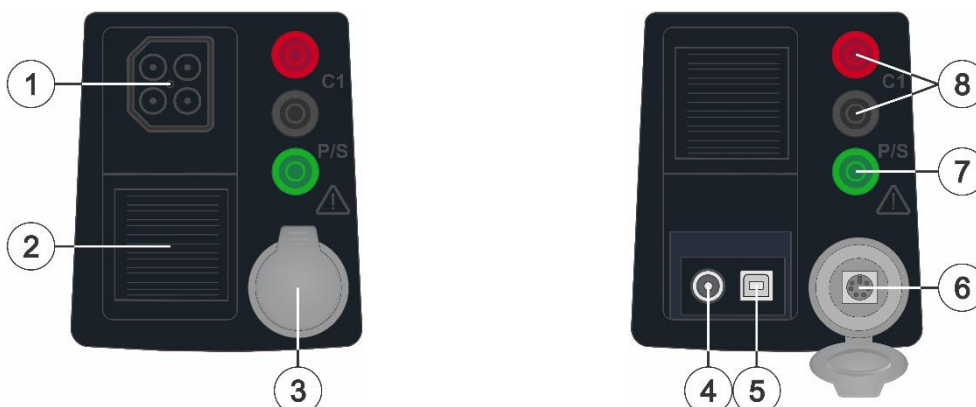

Figure 3.2: Connector panel

<b>Test connector</b>	
	L/L1 pin – In 4-wire measurements used as a current probe C1.
1	N/L2 pin – In 4-wire measurements used as a current probe C2.
	PE/L3 pin – In 4-wire measurements used as a voltage probe P2.
	S pin – In 4-wire measurements used as a voltage probe P1.
2	<b>Protection cover</b>
3	<b>Protection cover – PS/2 communication port</b>
<b>Charger socket</b>	
4	
5	<b>USB communication port</b> Communication with PC USB (2.0) port
6	<b>PS/2 communication port</b> Communication with PC RS232 serial port Connection to optional measuring adapters Connection to barcode / RFID reader
7	<b>P/S input</b> External probe input for contact voltage measurement
8	<b>C1 inputs</b> Current clamp measuring input



#### Warnings!

- › Maximum allowed voltage between any test terminal and ground is 550 V!
- › Maximum allowed voltage between test terminals on test connector is 550 V!
- › Maximum allowed voltage on test terminal C1 is 3 V!
- › Maximum short-term voltage of external power supply adapter is 14 V!

### 3.3 Back side



Figure 3.3: Back view

1	Battery / fuse compartment cover
2	Fixing screws for battery / fuse compartment cover
3	Back panel information label

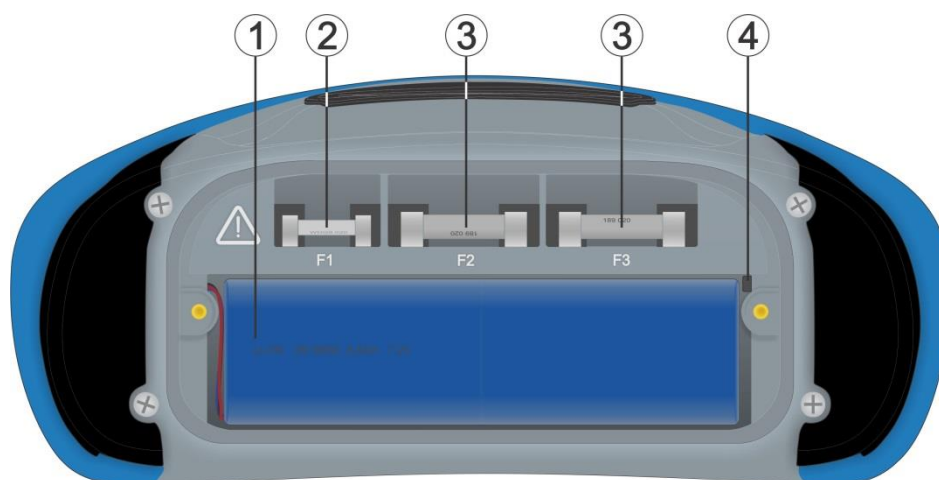

Figure 3.4: Battery and fuse compartment

1	Li-ion battery pack	Type: 18650T22A2S2P Type: 18650T22A2S4P (optional)
2	Fuse F1	M 315 mA / 250 V
3	Fuses F2 and F3	F 5 A / 500 V (breaking capacity 50 kA)



4 SD card slot

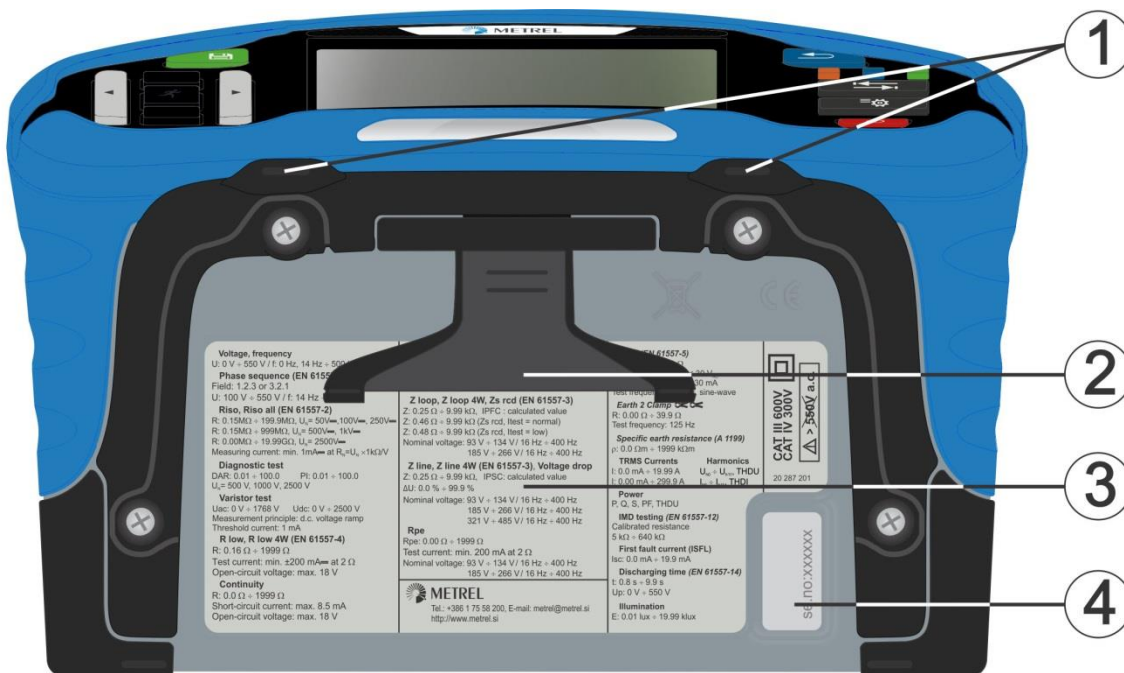
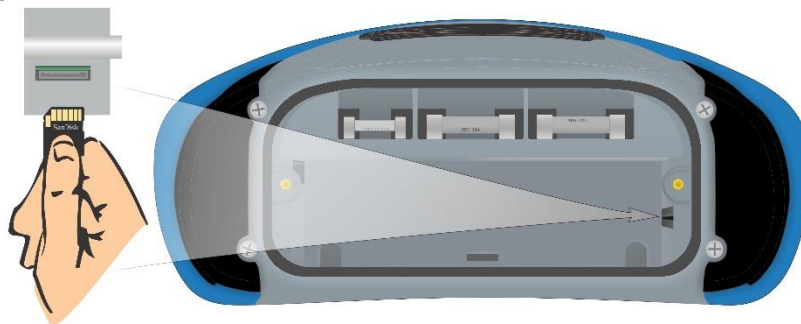

Figure 3.5: Bottom view

- 1 Neck belt openings
- 2 Stand for desktop use
- 3 Bottom information label
- 4 Serial number label

### 3.4 Carrying the instrument

With the neck-carrying belt supplied in standard set, various possibilities of carrying the instrument are available. Operator can choose appropriate one on basis of his operation, see the following examples:



The instrument hangs around operator's neck only – quick placing and displacing.



The instrument can be used even when placed in soft carrying bag – test cable connected to the instrument through the front aperture.

#### 3.4.1 Secure attachment of the strap

You can choose between two methods:

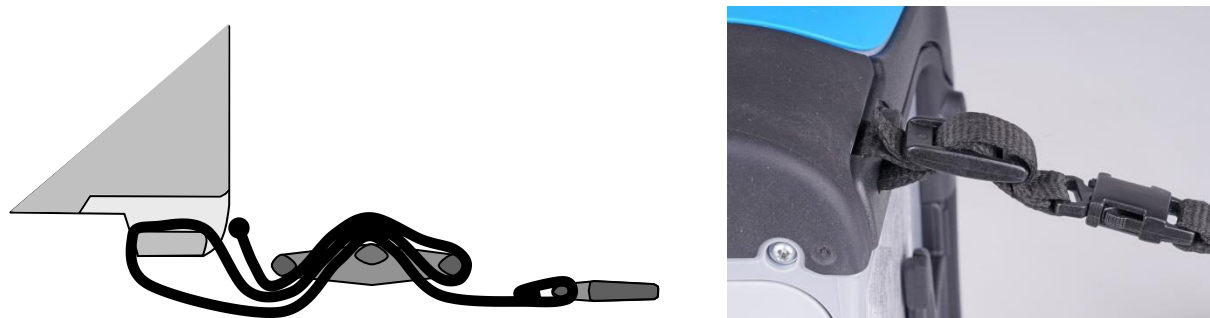
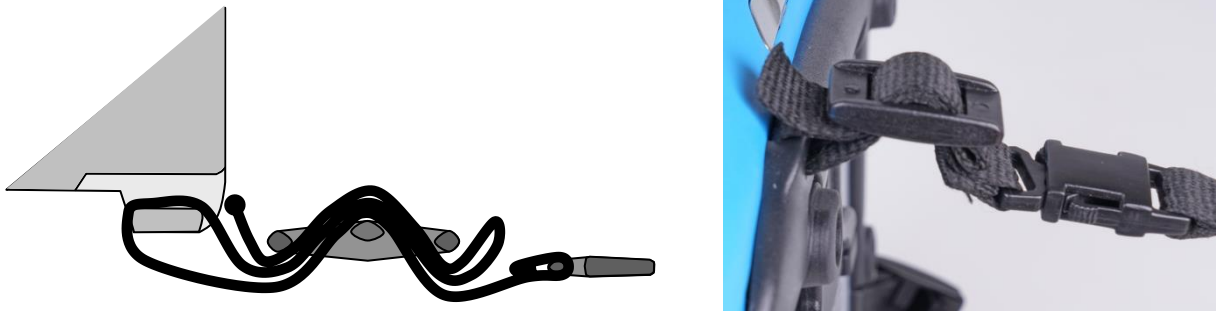

Figure 3.6: First method



**Figure 3.7: Alternative method**

Please perform a periodical check of the attachment.

## 4 Instrument operation

The EurotestXD instrument can be manipulated via a keypad or touch screen.

### 4.1 General meaning of keys

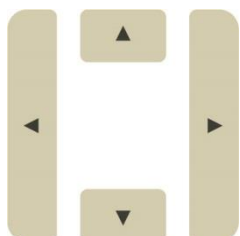

Cursor keys are used to:

- › select appropriate option.



Run key is used to:

- › confirm selected option;
- › start and stop measurements;
- › test PE potential.



Escape key is used to:

- › return to previous menu without changes;
- › abort measurements.



Option key is used to:

- › expand column in control panel.



Save key is used to:

- › store test results.



Auto Sequences® key is used as:

- › ...shortcut key to enter Auto Sequences® menu.



Single Tests key is used as:

- › shortcut key to enter Single Tests menu.



Memory Organizer key is used as:

- › shortcut key to enter Memory Organizer menu.



General Settings key is used to:

- › enter General Settings menu.



On / Off key is used to:

- › switch On / Off the instrument;
- › switch Off the instrument if pressed and held for 5 s.

## 4.2 General meaning of touch gestures

---



Tap (briefly touch surface with fingertip) is used to:

- › select appropriate option;
  - › confirm selected option;
  - › start and stop measurements.
- 



Swipe (press, move, lift) up / down is used to:

- › scroll content in same level;
  - › navigate between views in same level.
- 



**long**

Long press (touch surface with fingertip for at least 1 s) is used to:

- › select additional keys (virtual keyboard);
  - › enter cross selector from single test screens.
- 



Tap Escape icon is used to:

- › return to previous menu without changes;
  - › abort measurements.
-

### 4.3 Virtual keyboard



Figure 4.1: Virtual keyboard

<b>shift</b>	Toggle case between lowercase and uppercase. Active only when alphabetic characters keyboard layout selected.
<b>←</b>	Backspace Clears last character or all characters if selected. (If held for 2 s, all characters are selected).
<b>↵</b>	Enter confirms new text.
<b>12#</b>	Activates numeric / symbols layout.
<b>ABC</b>	Activates alphabetic characters.
<b>eng</b>	English keyboard layout.
<b>GR</b>	Greek keyboard layout.
<b>RU</b>	Russian keyboard layout.
<b>↶</b>	Returns to the previous menu without changes.

## 4.4 Display and sound

### 4.4.1 Terminal voltage monitor

The terminal voltage monitor displays on-line the voltages on the test terminals and information about active test terminals in the a.c. installation measuring mode.

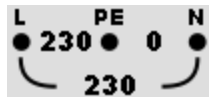

Online voltages are displayed together with test terminal indication.  
All three test terminals are used for selected measurement.

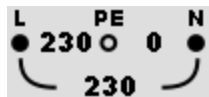

Online voltages are displayed together with test terminal indication.  
L and N test terminals are used for selected measurement.

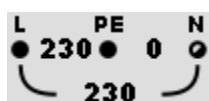

Online voltages are displayed together with test terminal indication.  
L and PE are active test terminals.  
N terminal should also be connected for correct input voltage condition.

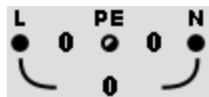

L and N are active test terminals.  
PE terminal should also be connected for correct input voltage condition.

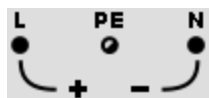

Polarity of test voltage applied to the output terminals, L and N.

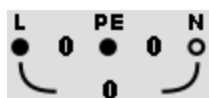
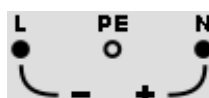

L and PE are active test terminals.

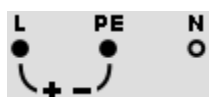

Polarity of test voltage applied to the output terminals, L and PE.

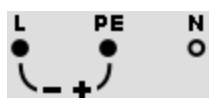

2.5 kV Insulation measurement terminal screen.

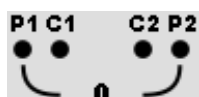

4-wire test terminal indication.

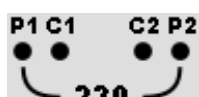

4-wire test terminal indication with online voltage between P1 and P2 probes.

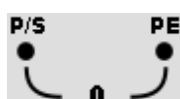

Test terminals for Discharging time measurement.

## 4.4.2 Battery indication

The battery indication indicates the charge condition of battery and connection of external charger.



Battery capacity indication.

Battery is in good condition.



Battery is full.



Low battery.

Battery is too weak to guarantee correct result. Replace or recharge the battery cells.



Empty battery or no battery.



Charging in progress (if power supply adapter is connected).



Charging finished.

## 4.4.3 Measurement actions and messages



Conditions on the input terminals allow starting the measurement. Consider other displayed warnings and messages.



Conditions on the input terminals do not allow starting the measurement. Consider displayed warnings and messages.



Proceeds to next step of the measurement.



Stop the measurement.



Result(s) can be stored.



Starts test leads compensation in Rlow / continuity measurement.

Starts Zref line impedance measurement at origin of electrical installation in Voltage Drop measurement. Zref value is set to 0.00  $\Omega$  if pressing this touch key while instrument is not connected to a voltage source.



Use A 1199 Specific earth resistance adapter for this test.



Use A 1143 Euro Z 290 A adapter for this test.



Use A 1172 or A 1173 Illumination sensor for this test.



Count down timer (in seconds) within measurement.



Measurement is running, consider displayed warnings.



RCD tripped-out during the measurement (in RCD functions).





Instrument is overheated. The measurement is prohibited until the temperature decreases under the allowed limit.



High electrical noise was detected during measurement. Results may be impaired.

Indication of noise voltage above 5 V between H and E terminals during earth resistance measurement.



L and N are changed.

In most instrument profiles L and N test terminals are reversed automatically according to detected voltages on input terminal. In instrument profiles for countries where the position of phase and neutral connector is defined the selected feature is not working.



**Warning!** High voltage is applied to the test terminals.

The instrument automatically discharge tested object after finished insulation measurement.

When an insulation resistance measurement has been performed on a capacitive object, automatic discharge may not be done immediately! The warning symbol and the actual voltage are displayed during discharge until voltage drops below 30 V.



**Warning!** Dangerous voltage on the PE terminal! Stop the activity immediately and eliminate the fault / connection problem before proceeding with any activity!

Continuous sound warning and yellow coloured screen is also present.



Test leads resistance in R low / Continuity measurement is not compensated.



Test leads resistance in R low / Continuity measurement is compensated.



High resistance to earth of current test probes. Results may be impaired.



High resistance to earth of potential test probes. Results may be impaired.



High resistance to earth of potential and current test probes. Results may be impaired.



Too small current for declared accuracy. Results may be impaired. Check in Current Clamp Settings if sensitivity of current clamp can be increased.

In Earth 2 Clamp measurement results are very accurate for resistances below 10  $\Omega$ . At higher values (several 10  $\Omega$ ) the test current drops to few mA. The measuring accuracy for small currents and immunity against noise currents must be considered!



Measured signal is out of range (clipped). Results are impaired.



Single fault condition in IT system.



Fuse F1 is broken.

#### 4.4.4 Result indication



Measurement result is inside pre-set limits (PASS).



Measurement result is out of pre-set limits (FAIL).



Measurement is aborted. Consider displayed warnings and messages.

RCD t and RCD I measurements will only be performed if the contact voltage in the pre-test at nominal differential current is lower than the set contact voltage limit!

#### 4.4.5 Auto Sequence® result indication



All Auto Sequence® results are inside pre-set limits (PASS).



One or more Auto Sequence® results are out of pre-set limits (FAIL).



Overall Auto Sequence® result without PASS/FAIL indication



Overall Auto Sequence® result with empty (aborted) single tests



Measurement result is inside pre-set limits (PASS).



Measurement result is out of pre-set limits (FAIL).



Measurement result without PASS / FAIL indication.



Measurement not performed.

## 4.5 Instruments main menu

From the **Main menu** different main operation menus can be selected.

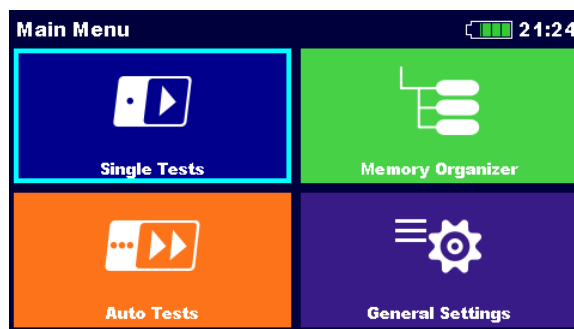
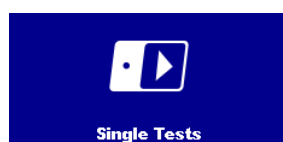

Figure 4.2: Main menu

### Options



#### Single Tests

Menu with single tests, see chapter **6 Single tests**.



#### Auto Sequences®

Menu with customized test sequences, see chapter **8 Auto Sequences®**.



#### Memory Organizer

Menu for working with and documentation of test data, see chapter **5 Memory Organizer**.



#### General Settings

Menu for setup of the instrument, see chapter **4.6 General Settings**.

## 4.6 General Settings

In the **General settings menu** general parameters and settings of the instrument can be viewed or set.

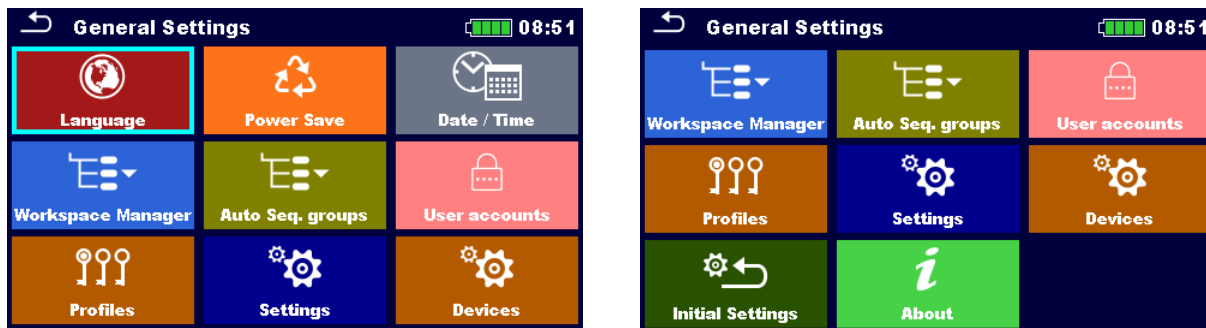

Figure 4.3: General settings menu

### Options



#### Language

Instrument language selection.



#### Power Save

Brightness of LCD, enabling/disabling Bluetooth communication.



#### Date /Time

Instruments Date and time.



#### Workspace Manager

Manipulation with project files. Refer to chapter **4.8 Workspace Manager** for more information.



#### Auto Sequences® groups

Manipulation with lists of Auto Sequences®. Refer to chapter **4.9 Auto Sequence® groups** for more information.



#### User accounts

User accounts settings. Refer to chapter **4.6.6 User accounts** for more information.



#### Instrument Profile

Selection of available instrument profiles. Refer to chapter **4.7 Instrument profiles** for more information.



#### Settings

Refer to chapter **4.6.8 Settings** for more information.



#### Devices

Selection of external devices. Refer to chapter **4.6.9 Devices** for more information.



**Initial Settings**  
Factory settings.



**About**  
Instrument info.

### 4.6.1 Language

In this menu the language of the instrument can be set.



Figure 4.4: Language menu

### 4.6.2 Power Save

In this menu different options for decreasing power consumption can be set.

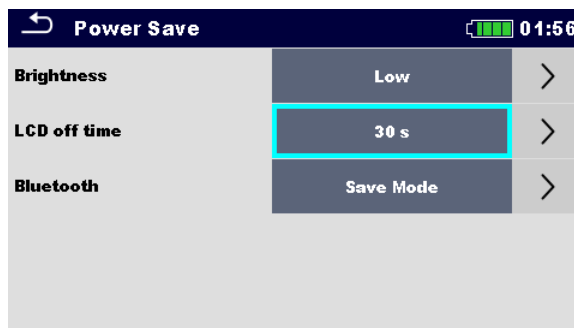

Figure 4.5: Power save menu

<b>Brightness</b>	Setting level of LCD brightness level. Power saving at low level: approx. 15%
<b>LCD off time</b>	Setting LCD off after set time interval. LCD is switched on after pressing any key or touching the LCD. Power saving at LCD off (at low level brightness): approx. 20%
<b>Bluetooth</b>	Always On: Bluetooth module is ready to communicate. Save mode: Bluetooth module is set to sleep mode and is not functioning. Power saving in Save mode: 7 %

### 4.6.3 Date and time

In this menu date and time of the instrument can be set.

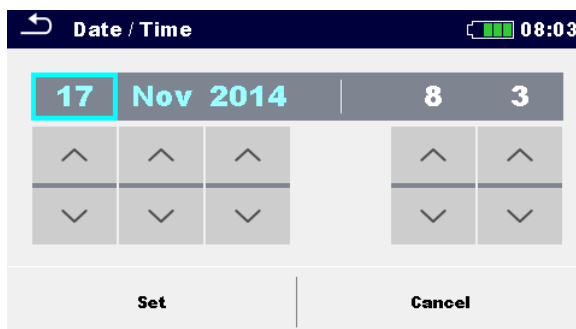

Figure 4.6: Setting date and time

**Note:**

- If the batteries are removed the set date and time will be lost.

### 4.6.4 Workspace manager

Refer to chapter **4.8 Workspace Manager** for more information.

### 4.6.5 Auto Sequences® groups

Refer to chapter **4.9 Auto Sequence® groups** for more information.

### 4.6.6 User accounts

The demand to sign in can prevent from unauthorized persons to work with the instrument. In this menu user accounts can be managed:

- Setting if signing in to work with the instrument is required or not.
- Adding and deleting new users, setting their user names and passwords.

The user accounts can be managed by the administrator.

Factory set administrator password: ADMIN

It is recommended to change factory set administrator password after first use. If the custom password is forgotten the second administrator password can be used. This password always unlocks the Account manager and is delivered with the instrument.

If a user account is set and the user is signed in the user's name will be stored in memory for each measurement.

Individual users can change their passwords.

#### 4.6.6.1 Signing in

If signing in is demanded the user must enter the password in order to work with the instrument.

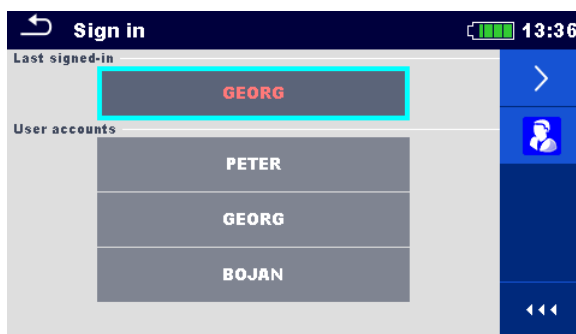

Figure 4.7: Sign in menu

#### Options

User signing in



The user should be selected first.  
The last used user is displayed in the first row.



Sign in with selected user name.

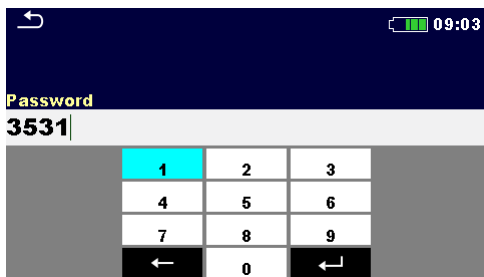

Enter the password and confirm.  
The user password consists of an up to 4 digit number.

### Administrator signing in



The Account manager menu is accessed by selecting Account manager in Sign in menu or User profile menu.

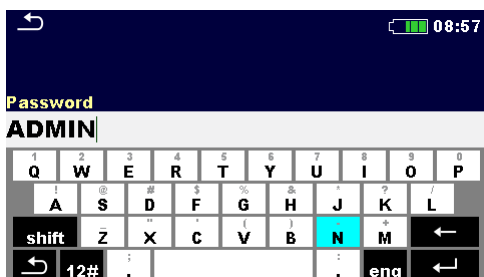

The account manager password must be entered and confirmed first.  
Administrator password consists of letters and/or numbers. Letters are case sensitive.  
The default password is ADMIN.

### 4.6.6.2 Changing user password, signing out

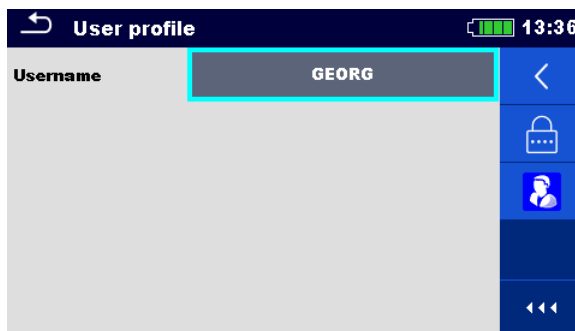

Figure 4.8: User profile menu

#### Options



Signs out the set user.



Enters procedure for changing the user's password.



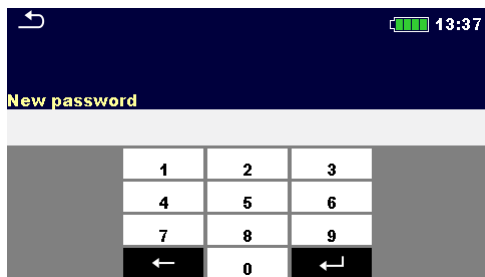

The user can change its password. The actual password must be entered first followed by the new password.



Enters the Account manager menu.

### 4.6.6.3 Managing accounts

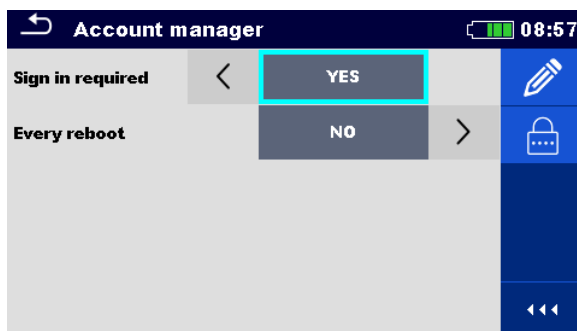
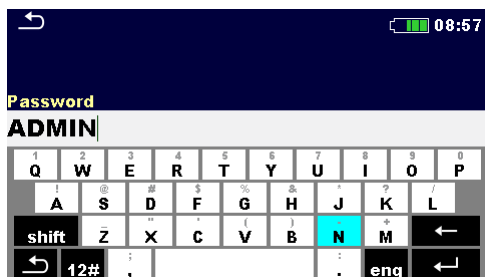

Figure 4.9: Account manager menu

#### Options



The Account manager menu is accessed by selecting Account manager in Sign in menu or User profile menu.



The account manager password must be entered and confirmed first.

The default password is ADMIN.

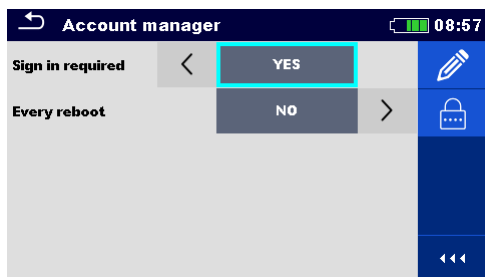

Field for setting if signing in is required to work with the instrument.

Field for setting if signing is required once or at each power on of the instrument.

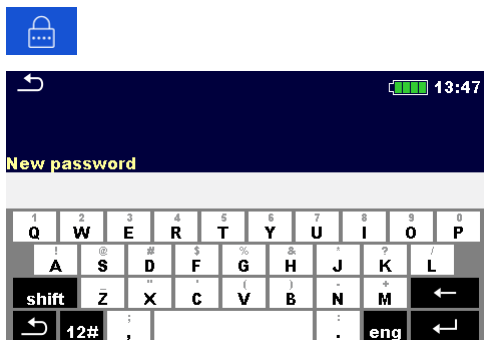

Enters procedure for changing the account manager (administrator) password.  
To change the password the actual and then the new password should be entered and confirmed.



Enters menu for editing user accounts.

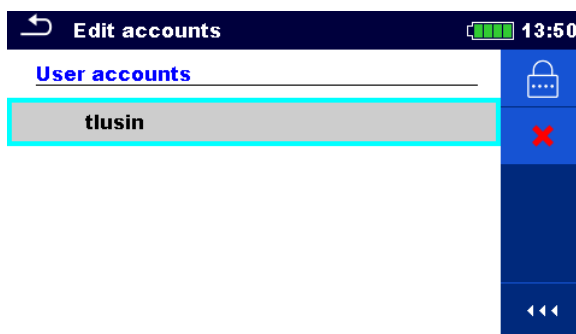
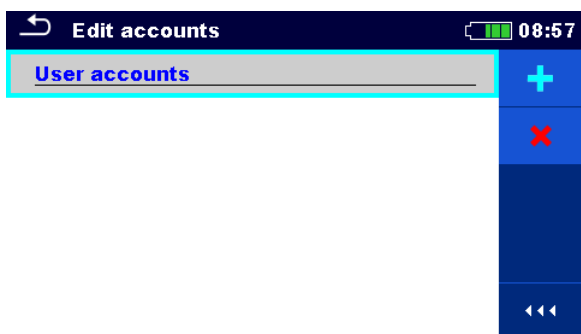
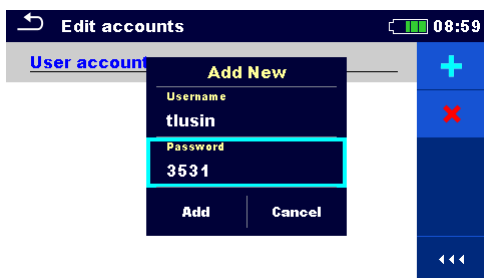

Figure 4.10: Edit accounts menu

Options



Opens the window for adding a new user.



In the Add New window the name and initial password of the new user account are to be set.  
'Add' confirms the new user data.



Changes password of the selected user account.

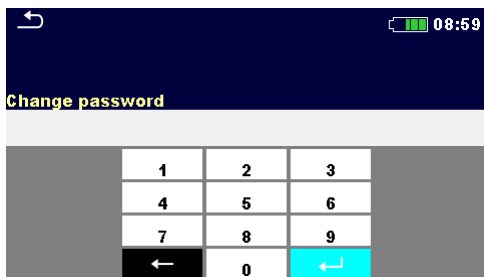

Deletes all user accounts.  
Deletes the selected user account.

## 4.6.7 Profiles

Refer to chapter **4.7 Instrument profiles** for more information.

## 4.6.8 Settings

In this menu different general parameters can be set.

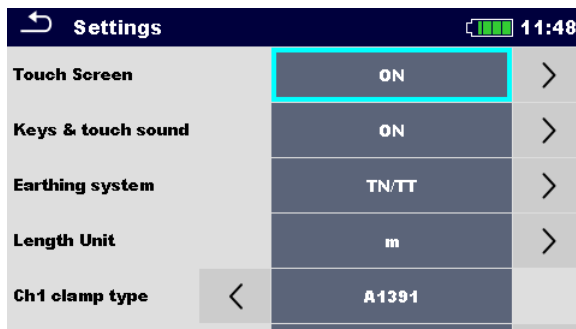

Figure 4.11: Settings menu

	Available selection	Description
<b>Touch screen</b>	[ON, OFF]	Enables / disables operation with touch screen.
<b>Keys &amp; touch sound</b>	[ON, OFF]	Enables / disables sound when touch screen or key is pressed.
<b>Isc factor</b>	[0.20 ... 3.00] Default value: 1.00	Short circuit current Isc in the supply system is important for selection or verification of protective circuit breakers (fuses, over-current breaking devices, RCDs). The value should be set according to local regulative.
<b>Earthing system</b>	[TN/TT, IT]	Terminal voltage monitor and measuring functions are suited to selected earthing system. In some measuring functions the results and parameters are suited to the selected system.
<b>RCD Standard</b>	[EN 61008 / EN 61009, IEC 60364-4-41 TN/IT, IEC 60364-4-41 TT, BS 7671, AS/NZS 3017]	Used standard for RCD tests. Refer to the end of this chapter for more information. Maximum RCD disconnection times differ in various standards. The trip-out times defined in individual standards are listed below.
<b>Length Unit</b>	[m, ft]	Length unit for specific earth resistance measurement.
<b>Ch1 clamp type</b>	[A 1018, A 1019, A1391]	Model of current clamp adaptor.
<b>Range</b>	A 1018:[20 A] A1019: [20 A] A 1391: [40 A, 300 A]	Measuring range of selected current clamp adaptor. Measuring range of the instrument must be considered. Measurement range of current clamp adaptor can be higher than of the instrument.
<b>Merge fuses</b>	[yes, no]	[Yes]: fuse type and parameters set in one function are also kept for other functions! [No]: Fuse parameters will be considered only in function where they have been set.

<b>External Device</b>	[None, Commander]	The 'None' option is intended to disable the commander's remote keys. In case of high EM interfering noise the operation of the commander can be irregular.
<b>Ignore PE warning (IT)</b>	[yes, no]	[yes]: In IT earthing system the instrument will allow to start the selected measurement regardless of PE warning detection. [no], In IT earthing system the instrument will block the selected measurement if PE warning is detected.
<b>IscMax, IscMin calculation</b>	[yes, no]	[yes]: IscMax, IscMin calculation is enabled in Z line measurement. [no]: IscMax, IscMin calculation is disabled in Z line measurement.
<b>Limit Uc</b>	[12 V, 25 V, 50 V]	Contact voltage limit.

#### 4.6.8.1 RCD standard

Maximum RCD disconnection times differ in various standards. The trip-out times defined in individual standards are listed below.

	$\frac{1}{2} \times I_{\Delta N}^{1)}$	$I_{\Delta N}$	$2 \times I_{\Delta N}$	$5 \times I_{\Delta N}$
<b>General RCDs (non-delayed)</b>	$t_{\Delta} > 300$ ms	$t_{\Delta} < 300$ ms	$t_{\Delta} < 150$ ms	$t_{\Delta} < 40$ ms
<b>Selective RCDs (time-delayed)</b>	$t_{\Delta} > 500$ ms	$130$ ms $< t_{\Delta} < 500$ ms	$60$ ms $< t_{\Delta} < 200$ ms	$50$ ms $< t_{\Delta} < 150$ ms

**Table 4.1: Trip-out times according to EN 61008 / EN 61009**

Test according to standard IEC/HD 60364-4-41 has two selectable options:

- **IEC 60364-4-41 TN/IT** and
- **IEC 60364-4-41 TT**

The options differ to maximum disconnection times as defined in IEC/HD 60364-4-41 Table 41.1.

	$U_0^{3)}$	$\frac{1}{2} \times I_{\Delta N}^{1)}$	$I_{\Delta N}$	$2 \times I_{\Delta N}$	$5 \times I_{\Delta N}$
<b>TN / IT</b>	$\leq 120$ V	$t_{\Delta} > 800$ ms	$t_{\Delta} \leq 800$ ms	$t_{\Delta} < 150$ ms	$t_{\Delta} < 40$ ms
	$\leq 230$ V	$t_{\Delta} > 400$ ms	$t_{\Delta} \leq 400$ ms		
<b>TT</b>	$\leq 120$ V	$t_{\Delta} > 300$ ms	$t_{\Delta} \leq 300$ ms		
	$\leq 230$ V	$t_{\Delta} > 200$ ms	$t_{\Delta} \leq 200$ ms		

**Table 4.2: Trip-out times according to IEC/HD 60364-4-41**

	$\frac{1}{2} \times I_{\Delta N}^{1)}$	$I_{\Delta N}$	$2 \times I_{\Delta N}$	$5 \times I_{\Delta N}$
<b>General RCDs (non-delayed)</b>	$t_{\Delta} > 1999$ ms	$t_{\Delta} < 300$ ms	$t_{\Delta} < 150$ ms	$t_{\Delta} < 40$ ms
<b>Selective RCDs (time-delayed)</b>	$t_{\Delta} > 1999$ ms	$130$ ms $< t_{\Delta} < 500$ ms	$60$ ms $< t_{\Delta} < 200$ ms	$50$ ms $< t_{\Delta} < 150$ ms

**Table 4.3: Trip-out times according to BS 7671**

RCD type	$I_{\Delta N}$ (mA)	$\frac{1}{2} \times I_{\Delta N}^{1)}$ $t_{\Delta}$	$I_{\Delta N}$ $t_{\Delta}$	$2 \times I_{\Delta N}$ $t_{\Delta}$	$5 \times I_{\Delta N}$ $t_{\Delta}$	Note
I	$\leq 10$		40 ms	40 ms	40 ms	Maximum break time
II	$> 10 \leq 30$	$> 999$ ms	300 ms	150 ms	40 ms	
III	$> 30$		300 ms	150 ms	40 ms	
IV <b>S</b>	$> 30$	$> 999$ ms	500 ms 130 ms	200 ms 60 ms	150 ms 50 ms	Minimum non-actuating time

Table 4.4: Trip-out times according to AS/NZS 3017<sup>2)</sup>

Standard	$\frac{1}{2} \times I_{\Delta N}$	$I_{\Delta N}$	$2 \times I_{\Delta N}$	$5 \times I_{\Delta N}$
EN 61008 / EN 61009	300 ms	300 ms	150 ms	40 ms
IEC 60364-4-41	1000 ms	1000 ms	150 ms	40 ms
BS 7671	2000 ms	300 ms	150 ms	40 ms
AS/NZS 3017 (I, II, III)	1000 ms	1000 ms	150 ms	40 ms

Table 4.5: Maximum test times related to selected test current for general (non-delayed) RCD

Standard	$\frac{1}{2} \times I_{\Delta N}$	$I_{\Delta N}$	$2 \times I_{\Delta N}$	$5 \times I_{\Delta N}$
EN 61008 / EN 61009	500 ms	500 ms	200 ms	150 ms
IEC 60364-4-41	1000 ms	1000 ms	150 ms	40 ms
BS 7671	2000 ms	500 ms	200 ms	150 ms
AS/NZS 3017 (IV)	1000 ms	1000 ms	200 ms	150 ms

Table 4.6: Maximum test times related to selected test current for selective (time-delayed) RCD

<sup>1)</sup> Minimum test period for current of  $\frac{1}{2} \times I_{\Delta N}$ , RCD shall not trip-out.

<sup>2)</sup> Test current and measurement accuracy correspond to AS/NZS 3017 requirements.

<sup>3)</sup>  $U_0$  is nominal  $U_{LPE}$  voltage.

**Note:**

- › Trip-out limit times for PRCD, PRCD-K and PRCD-S are equal to General (non-delayed) RCDs.

### 4.6.9 Devices

In this menu operation with external devices is configured.

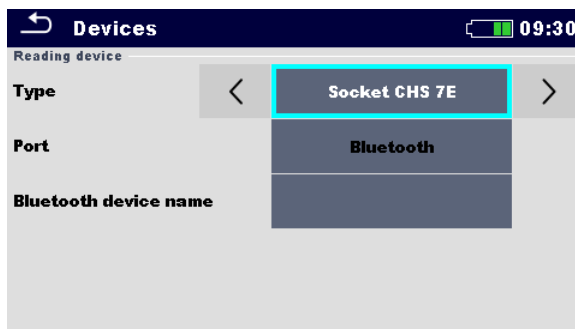

Figure 4.12: Device settings menu

## Reading devices

<b>Type</b>	Sets appropriate reading device (QR or barcode scanner, RFID reader, via aMESM application).
<b>Port</b>	Sets communication port of selected reading device.
<b>Bluetooth device name</b>	Goes to menu for pairing with selected Bluetooth device.

### 4.6.10 Initial Settings

In this menu the instrument settings, measurement parameters and limits can be set to initial (factory) values.

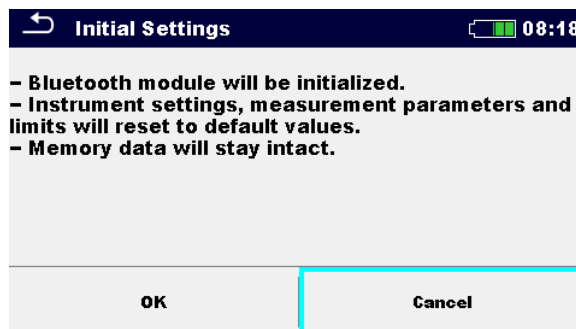

Figure 4.13: Initial settings menu

#### Warning!

Following customized settings will be lost when setting the instruments to initial settings:

- › measurement limits and parameters,
- › global parameters, system settings, and Devices in General settings menu,
- › opened Workspace and Auto Sequences® group will be deselected,
- › user will be signed out.
  
- › If the battery pack is removed the custom made settings will be lost.

#### Note:

Following customized settings will stay:

- › profile settings,
- › data in memory (Data in memory organizer, Workspaces, Auto Sequences® groups, Auto Sequences®) and
- › user accounts.

## 4.6.11 About

In this menu instrument data (name, serial number, firmware (FW) and hardware (HW) version, fuse version and date of calibration) can be viewed.



About <span style="float: right;">21:26</span>	
Name	MI 3155 EurotestXD
S/N	17120430
FW version	0.8.8.8256 - ATAA
HW version	1.0
Fuse version	1.06
Date of calibration	11.May.2017

Figure 4.14: Instrument info screen

## 4.7 Instrument profiles

In this menu the instrument profile can be selected from the available ones.

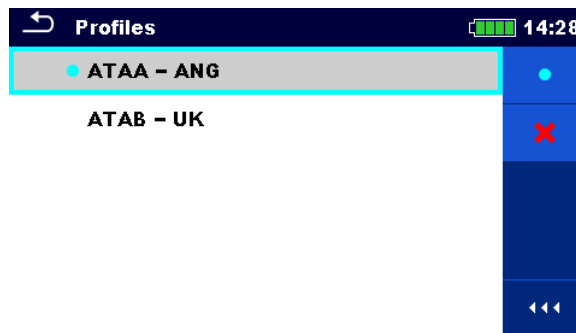

Figure 4.15: Instrument profiles menu

The instrument uses different specific system and measuring settings in regard to the scope of work or country it is used. These specific settings are stored in instrument profiles.

By default each instrument has at least one profile activated. Proper licence keys must be obtained to add more profiles to the instruments.

If different profiles are available they can be selected in this menu.

### Options



Loads the selected profile. The instrument will restart automatically with new profile loaded.



Deletes the selected profile.

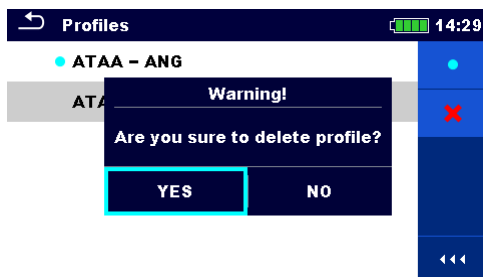

Before deleting the selected profile user is asked for confirmation.



Opens more options in control panel / expands column.



## 4.8 Workspace Manager

The Workspace Manager is intended to manage with different Workspaces and Exports that are stored on the SD memory card.

### 4.8.1 Workspaces and Exports

The works with MI 3155 EurotestXD can be organized and structured with help of Workspaces and Exports. Exports and Workspaces contain all relevant data (measurements, parameters, limits, structure objects) of an individual work.

Workspaces are stored on SD card on directory WORKSPACES, while Exports are stored on directory EXPORTS. Export files can be read by METREL applications that run on other devices. Exports are suitable for making backups of important works. To work on the instrument an Export should be imported first from the list of Exports and converted to a Workspace. To be stored as Export data a Workspace should be exported first from the list of Workspaces and converted to an Export.

### 4.8.2 Workspace Manager main menu

In Workspace manager Workspaces and Exports are displayed in two separated lists.

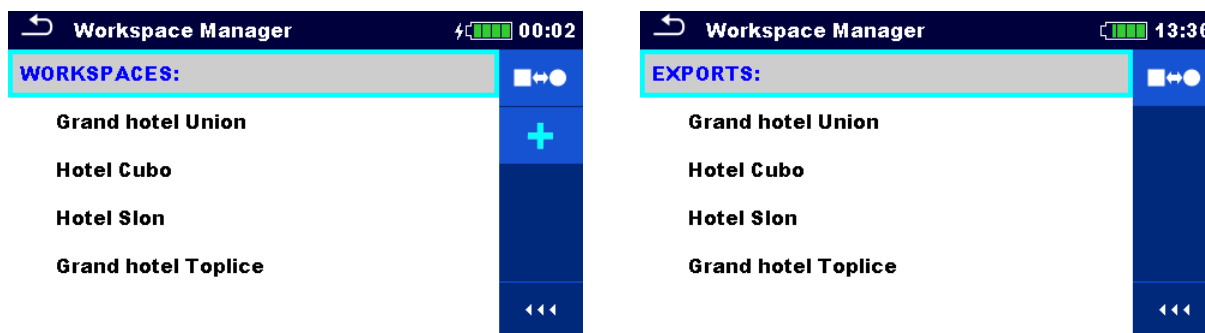

Figure 4.16: Workspace manager menu

#### Options

	List of Workspaces.
	Displays a list of Exports.
	Adds a new Workspace. Refer to chapter <b>4.8.5 Adding a new Workspace</b> for more information.
	List of Exports.
	Displays a list of Workspaces.
	Opens more options in control panel / expands column.

### 4.8.3 Operations with Workspaces

Only one Workspace can be opened in the instrument at the same time. The Workspace selected in the Workspace Manager will be opened in the Memory Organizer.

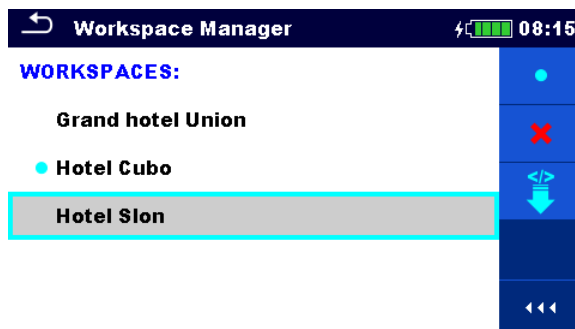

Figure 4.17: Workspaces menu

#### Options



Marks the opened Workspace in Memory Organizer.

Opens the selected Workspace in Memory Organizer.

Refer to chapter **4.8.6 Opening a Workspace** for more information.



Deletes the selected Workspace.

Refer to chapter **4.8.7 Deleting a Workspace / Export** for more information.



Adds a new Workspace.

Refer to chapter **4.8.5 Adding a new Workspace** for more information.



Exports a Workspace to an Export.

Refer to **4.8.9 Exporting a Workspace** for more information.



Opens more options in control panel / expands column.

### 4.8.4 Operations with Exports

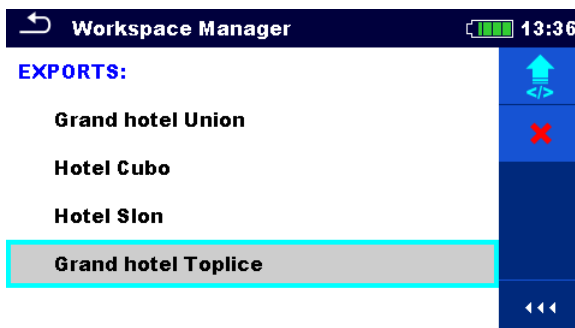

Figure 4.18: Workspace manager Exports menu

---

**Options**

---



Deletes the selected Export.

Refer to chapter **4.8.7 Deleting a Workspace / Export** for more information.

---



Imports a new Workspace from Export.

Refer to **4.8.8 Importing a Workspace** for more information.

---





Opens more options in control panel / expands column.

---

### 4.8.5 Adding a new Workspace

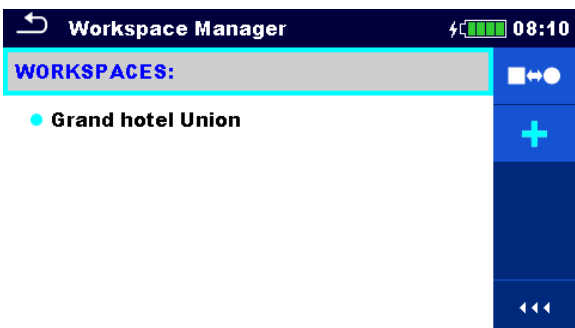
Procedure

①  New Workspaces can be added from the Workspace Manager screen.

②  Enters option for adding a new Workspace.  
Keypad for entering name of a new Workspace is displayed after selecting New.

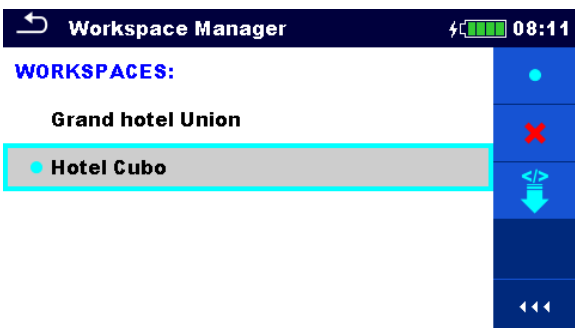
③  After confirmation a new Workspace is added in the list in Main Workspace Manager menu.

### 4.8.6 Opening a Workspace

Procedure

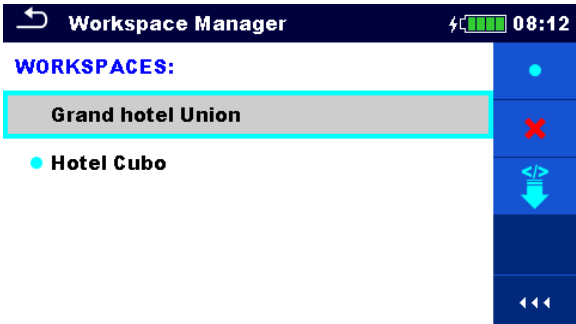
①  Workspace can be selected from a list in Workspace manager screen.

②  Opens a Workspace in Workspace manager.  
The opened Workspace is marked with a blue dot. The previously opened Workspace will close automatically.

### 4.8.7 Deleting a Workspace / Export

Procedure

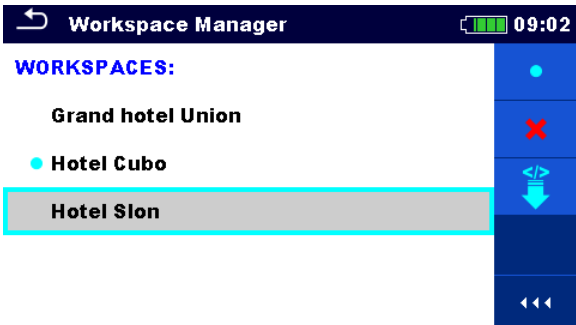
①  Workspace / Export to be deleted should be selected from the list of Workspaces / Exports.  
Opened workspace can't be deleted.

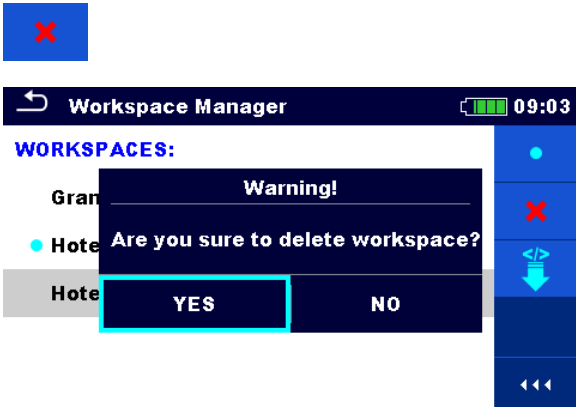
②  Enters option for deleting a Workspace / Export.  
Before deleting the selected Workspace / Export the user is asked for confirmation.



Workspace / Export is deleted from the Workspace / Export list.

### 4.8.8 Importing a Workspace



Select an Export file to be imported from Workspace manager Export list.



Enters option Import.

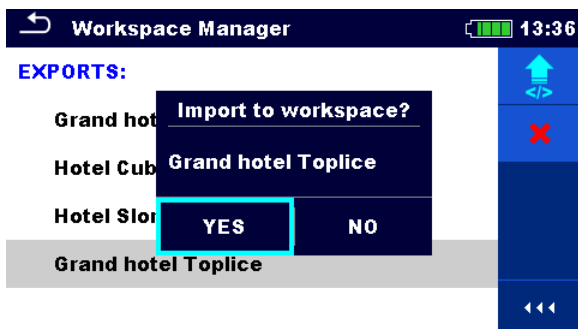

Before the import of the selected Export file the user is asked for confirmation.



The imported Export file is added to the list of Workspaces.

**Note:**  
If a Workspace with the same name already exists the name of the imported Workspace will be changed (name\_001, name\_002, name\_003, ...).

### 4.8.9 Exporting a Workspace

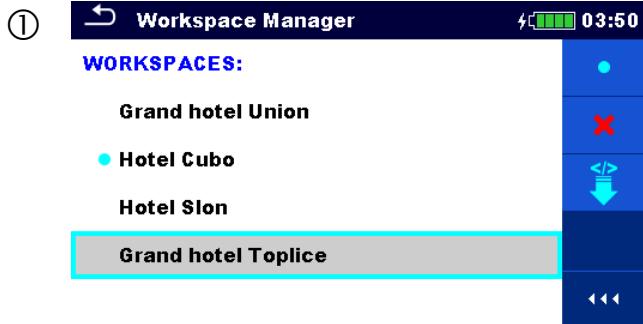

Select a Workspace from Workspace manager list to be exported to an Export file.



Enters option Export.



Before exporting the selected Workspace the user is asked for confirmation.

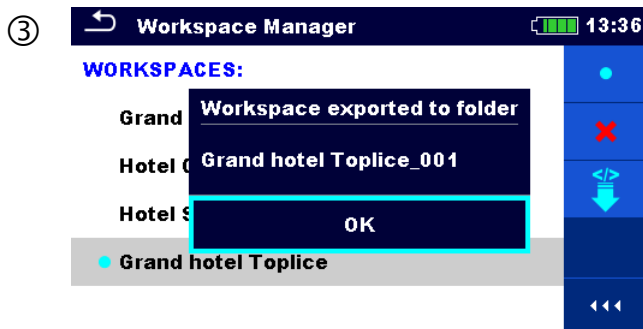

Workspace is exported to Export file and is added to the list of Exports.

**Note:**  
If an Export file with the same name already exists the name of the Export file will be changed (name\_001, name\_002, name\_003 ...).



## 4.9 Auto Sequence® groups

The Auto Sequences® in MI 3155 EurotestXD can be organized by using lists. In a list a group of similar Auto Sequences® is stored. The Auto Sequence® groups menu is intended to manage with different lists of Auto Sequences® that are stored on the SD card.

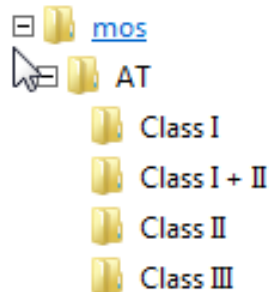

Figure 4.19: Organization of Auto Sequences® on SD card

Folders with lists of Auto Sequences® are stored in *Root\\_\_MOS\_\_\AT* on the SD card.

### 4.9.1 Auto Sequence® groups menu

In Auto Sequence® groups menu lists of Auto Sequences® are displayed. Only one list can be opened in the instrument at the same time. The list selected in the Auto Sequence® groups menu will be opened in the Auto Sequences® main menu.

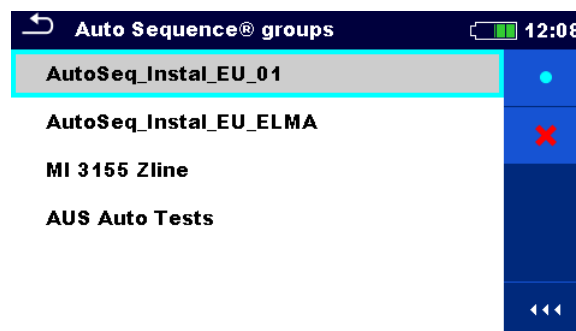

Figure 4.20: Auto Sequences® groups menu

Operations in Auto Sequences® groups menu



Opens the selected list of Auto Sequences®. Previously selected list of Auto Sequences® will be closed automatically. Refer to chapter 0

**Selecting a list of Auto Sequences®** for more information.



Deletes the selected list of Auto Sequences®. Refer to chapter 4.9.1.2 **Deleting a list of Auto** for more information.



Opens options in control panel / expands column.



### 4.9.1.1 Selecting a list of Auto Sequences®

**Procedure**

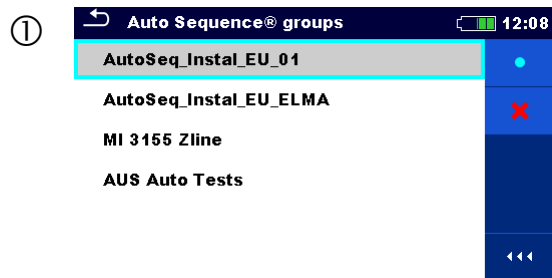

A list of Auto Sequences® can be selected from the Auto Sequence® groups menu.



Enters option for selecting a list.

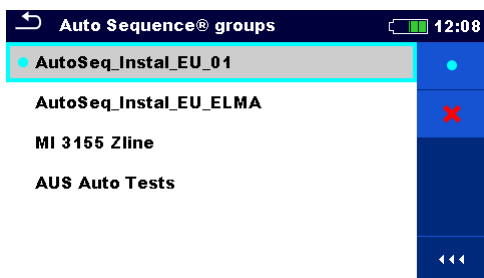

Selected list of Auto Sequences® is marked with a blue dot.

**Note:**

Previously selected list of Auto Sequences® is closed automatically.

### 4.9.1.2 Deleting a list of Auto Sequences®

**Procedure**

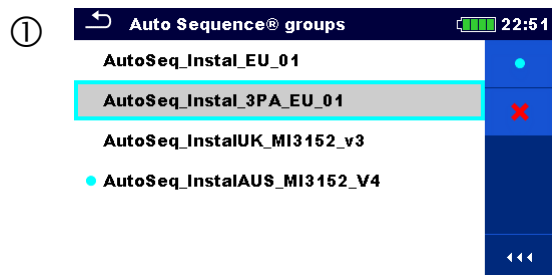

A list of Auto Sequences® to be deleted can be selected from the Auto Sequence® groups menu.



Enters option for deleting a list.

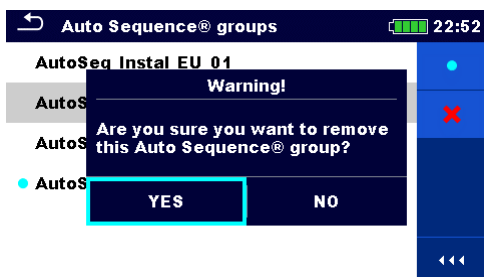

Before deleting the selected list of Auto Sequences® the user is asked for confirmation.

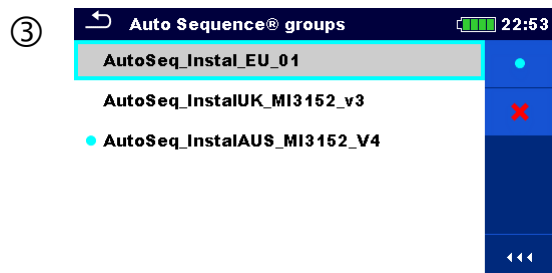

A list of Auto Sequences® is removed.

## 5 Memory Organizer

Memory Organizer is a tool for storing and working with test data.

### 5.1 Memory Organizer menu

The data is organized in a tree structure with Structure objects and Measurements. MI 3155 – EurotestXD Instrument has a multi-level structure. The hierarchy of Structure objects in the tree is shown on **Figure 5.1**. A list of available structure objects can be seen in **Appendix D – Structure objects**.

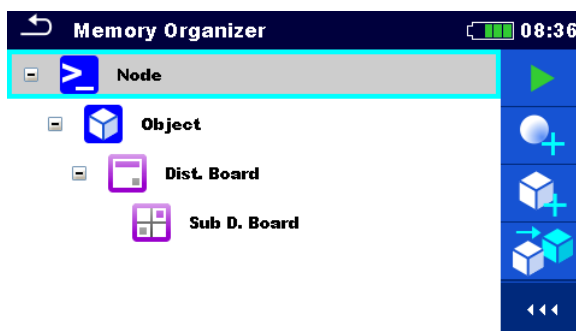

Figure 5.1: Default tree structure and its hierarchy

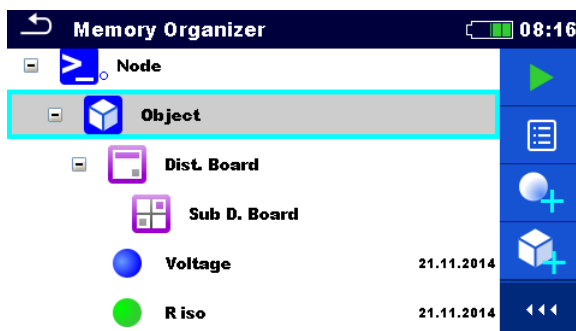

Figure 5.2: Example of a tree menu





#### 5.1.1 Measurement statuses

Each measurement has:









- › a status (PASS or FAIL or no status),
- › a name,
- › results,
- › limits and parameters.

A measurement can be a Single test or an Auto Sequence®. For more information refer to chapters **7 Tests and measurements** and **8 Auto Sequences®**.

## Statuses of Single tests

	passed finished single test with test results
	failed finished single test with test results
	finished single test with test results and no status
	empty single test without test results

## Overall statuses of Auto Sequence®

		At least one single test in the Auto sequence® passed and no single test failed
		At least one single test in the Auto Sequence® failed.
		At least one single test in the Auto Sequence® was carried out and there were no other passed or failed single tests.
		Empty Auto Sequence® with empty single tests.

## 5.1.2 Structure Objects

Each Structure object has:

- › an icon,
- › a name and
- › parameters.

Optionally they can have:

- › an indication of the status of the measurements under the Structure object and
- › a comment or a file attached.



Figure 5.3: Structure object in tree menu

Structure objects supported by the instrument are described in **Appendix D – Structure objects**.

### 5.1.2.1 Measurement status indication under the Structure object

Overall status of measurements under each structure element /sub-element can be seen without spreading tree menu. This feature is useful for quick evaluation of test status and as guidance for measurements.

Options

 **Object** There are no measurement results under selected structure object. Measurements should be made.

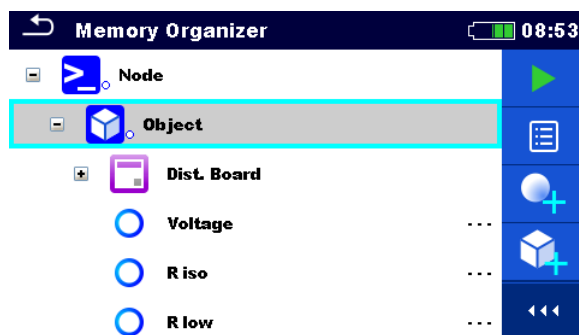

 **Object** One or more measurement result(s) under selected structure object has failed. Not all measurements under selected structure object have been made yet.

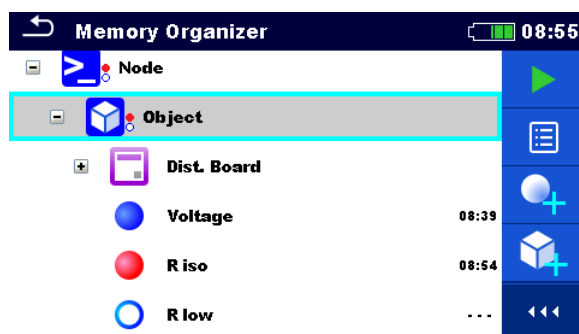

 **Object** All measurements under selected structure object are completed but one or more measurement result(s) has failed.

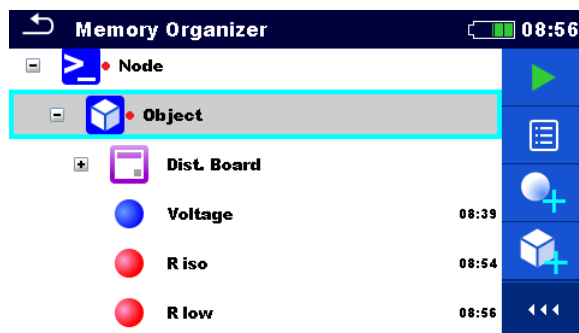

**Note:**

- There is no status indication if all measurement results under each structure element / sub-element have passed or if there is an empty structure element / sub-element (without measurements).

### 5.1.3 Selecting an active Workspace in Memory Organizer

Memory Organizer and Workspace Manager are interconnected so an active Workspace can be selected also in the Memory Organizer menu.

#### Procedure

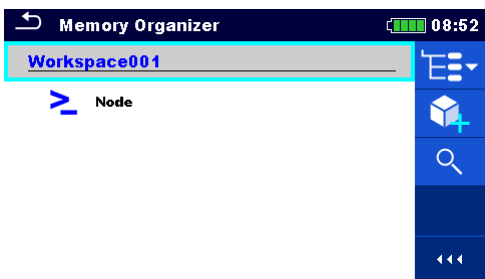
①  Press the active Workspace in Memory Organizer Menu.

②  Select List of Workspaces in Control panel.

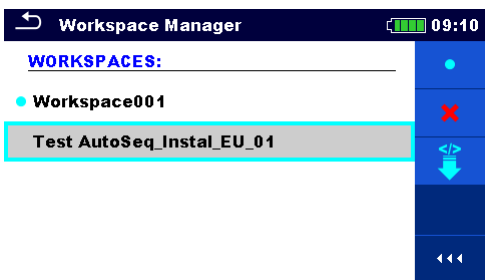
③  Choose desired Workspace from a list of Workspaces.

④  Use Select button to confirm selection.

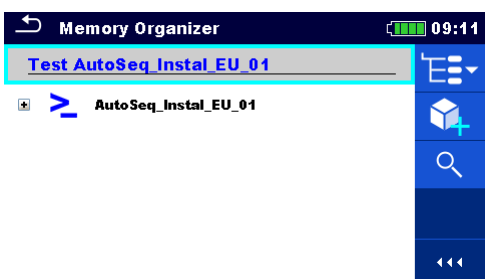
⑤  New Workspace is selected and displayed on the screen.

### 5.1.4 Adding Nodes in Memory Organizer

Structural Elements (Nodes) are used to ease organization of data in the Memory Organizer. One Node is a must; others are optional and can be created or deleted freely.

#### Procedure

①

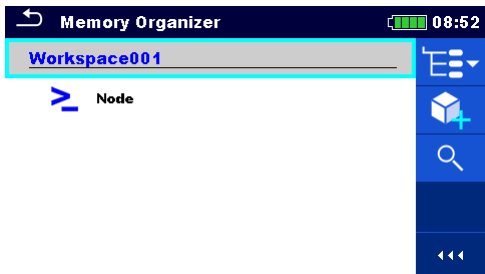

Press the active Workspace in Memory Organizer Menu.

②



Select Add New Structure Element in Control panel.

③

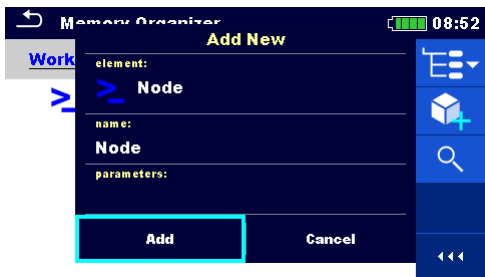

Change name of the Node if necessary and press Add to confirm.

④

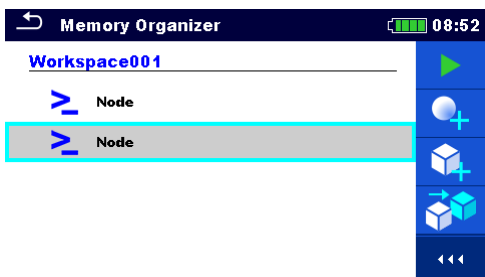

New Structure Element (Node) will be added.

## 5.1.5 Operations in Tree menu

In the Memory organizer different actions can be taken with help of the control panel at the right side of the display. Possible actions depend on the selected element in the organizer.

### 5.1.5.1 Operations on measurements (finished or empty measurements)

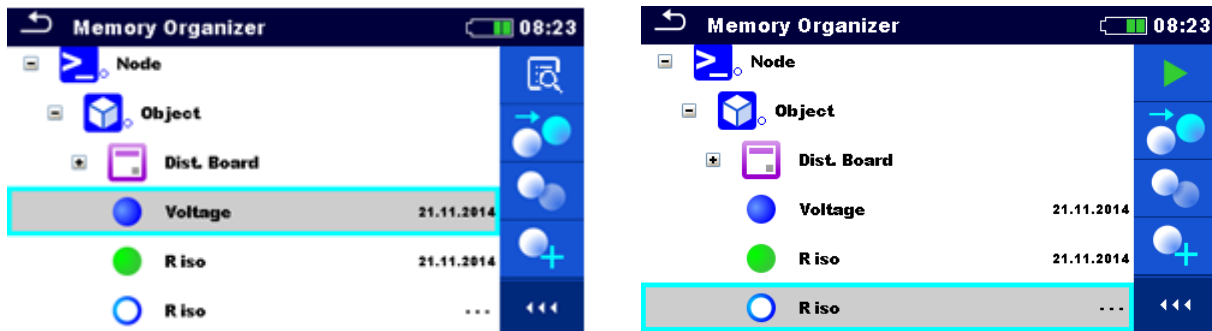

Figure 5.4: A measurement is selected in the Tree menu

#### Options



Views results of measurement.

The instrument goes to the measurement memory screen. Refer to chapter **6.1.9 Recall single test results screen** and **8.2.4 Auto Sequence® memory screen** for more information.



Starts a new measurement.

The instrument goes to the measurement start screen. Refer to chapter **6.1.3 Single test start screen** and **8.2.1 Auto Sequence® view menu** for more information.



Saves a measurement.

Saving of measurement on a position after the selected (empty or finished) measurement.



Clones the measurement.

The selected measurement can be copied as an empty measurement under the same Structure object. Refer to chapter **5.1.5.7 Clone a measurement** for more information.



Copies & Paste a measurement.

The selected measurement can be copied and pasted as an empty measurement to any location in structure tree. Multiple 'Paste' is allowed. Refer to chapter **5.1.5.10 Copy & Paste a measurement** for more information.



Adds a new measurement.

The instrument goes to the Menu for adding measurements. Refer to chapter **5.1.5.5 Add a new measurement** for more information.



Views and edit comments.

The instrument displays comment attached to the selected measurement or opens keypad for entering a new comment.



Deletes a measurement.

Selected Measurement can be deleted. User is asked for confirmation before the deleting. Refer to chapter **5.1.5.12 Delete a measurement** for more information.

### 5.1.5.2 Operations on Structure objects

The structure object must be selected first.

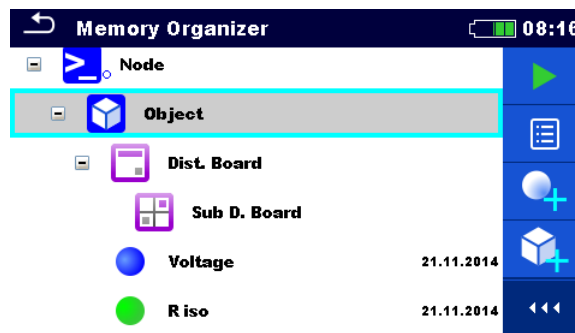

Figure 5.5: A structure object is selected in the Tree menu

#### Options



Starts a new measurement.

Type of measurement (Single test or Auto Sequence®) should be selected first. After proper type is selected, the instrument goes to Single Test or Auto Sequence® selection screen. Refer to chapters **6.1 Selection modes** and **8.1 Selection of Auto Sequences®**.



Saves a measurement.

Saving of measurement under the selected Structure object.



View / edit parameters and attachments.

Parameters and attachments of the Structure object can be viewed or edited.

Refer to chapter **5.1.5.3 View / Edit parameters and attachments of a Structure object** for more information.



Adds a new measurement.

The instrument goes to the Menu for adding measurement into structure. Refer to chapter **5.1.5.5 Add a new measurement** for more information.



Adds a new Structure object.

A new Structure object can be added. Refer to chapter **5.1.5.4 Add a new Structure Object** for more information.



Attachments.

Name and link of attachment is displayed.



Clones a Structure object.

Selected Structure object can be copied to same level in structure tree (clone). Refer to chapter **5.1.5.6 Clone a Structure object** for more information.





Copies & Paste a Structure object.



Selected Structure object can be copied and pasted to any allowed location in structure tree. Multiple “Paste” is allowed. Refer to chapter **5.1.5.8 Copy & Paste a Structure object** for more information.



Views and edit comments.

The instrument displays comment attached to the selected Structure object or opens keypad for entering a new comment.



Deletes a Structure object.

Selected Structure object and sub-elements can be deleted. User is asked for confirmation before the deleting. Refer to chapter **5.1.5.11 Delete a Structure object** for more information.



Renames a Structure object.

Selected Structure object can be renamed via keypad. Refer to chapter **5.1.5.13 Rename a Structure object** for more information.

---

### 5.1.5.3 View / Edit parameters and attachments of a Structure object

The parameters and their content are displayed in this menu. To edit the selected parameter, tap on it or press the  key to enter menu for editing parameters.

#### Procedure

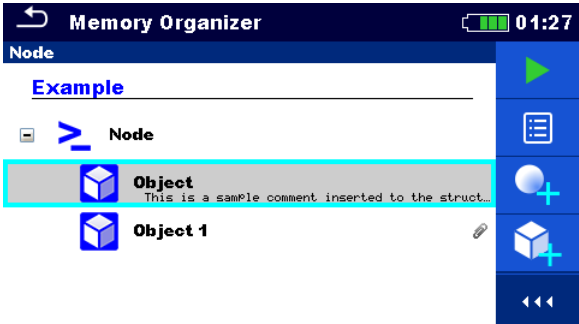
①  Select structure object to be edited.

②  Select Parameters in Control panel.

③  Example of Parameters menu.

None	
Name (designation) of object	Object
Description (of object)	
Location (of object)	
Data	

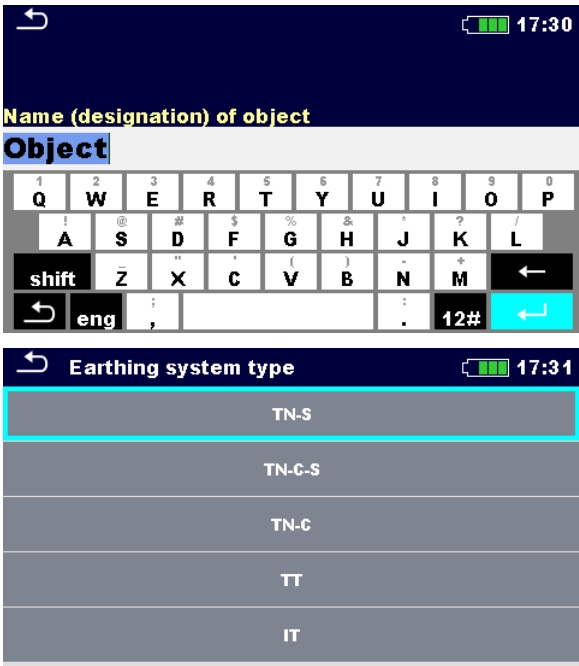
④  In menu for editing parameters the parameter's value can be selected from a dropdown list or entered via keypad. Refer to chapter **4 Instrument operation** for more information about keypad operation.

②a  Select Attachments in Control panel.

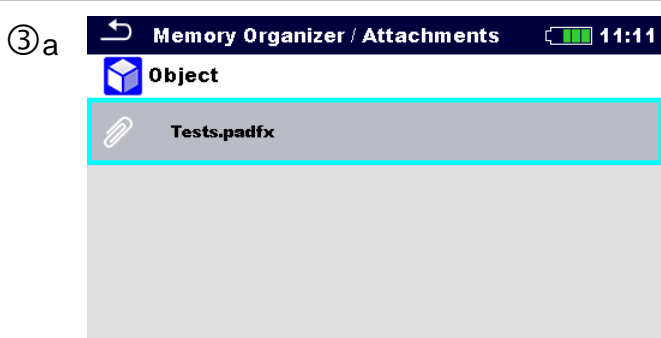

Attachments

The name of attachment can be seen. Operation with attachments is not supported in the instrument.



Select Comments in Control panel.



View or edit comments

Complete comment (if exists) attached to the structure object can be seen on this screen.

Press  key or tap on screen to open keypad for entering a new comment.

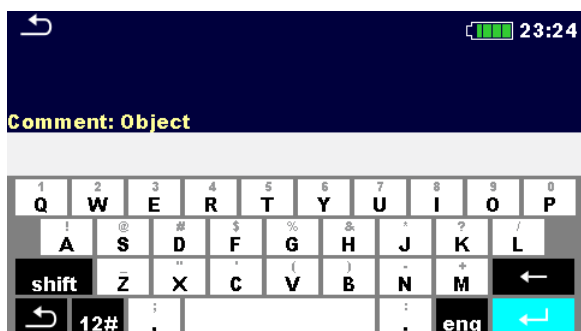

### 5.1.5.4 Add a new Structure Object

This menu is intended to add new structure objects in the tree menu. A new structure object can be selected and then added in the tree menu.

#### Procedure

- ①

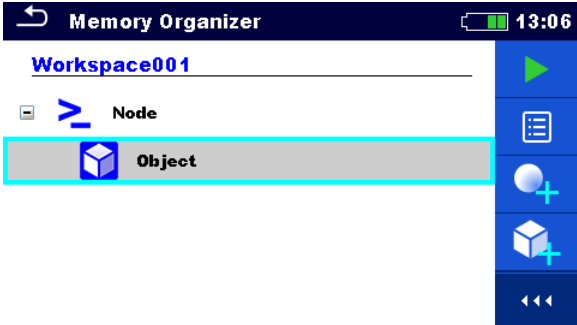

Default initial structure.

---

- ②



Select Add Structure in Control panel.

---

- ③



Add a new structure object menu.

---

- ③a



The type of structure object to be added can be selected first from dropdown menu.

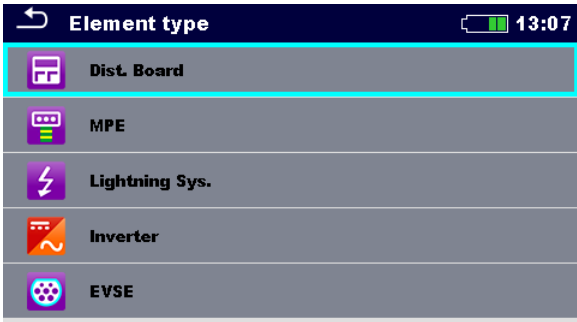

Only structure objects that can be used in the same level or next sub-level are offered.

---

- ③b

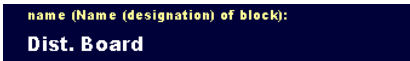

The name of structure object can be edited.

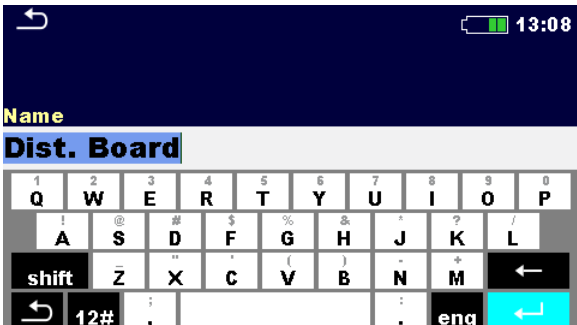

③c

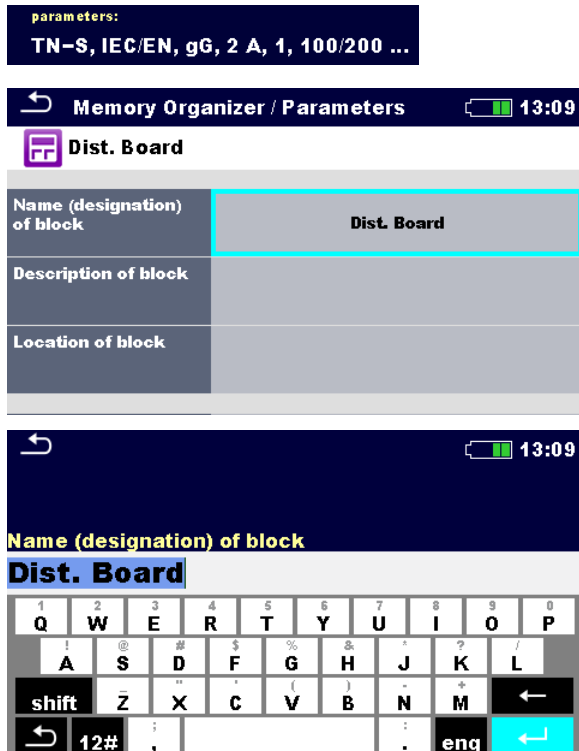

Parameters of the Structure object can be edited.

④



Adds the selected structure object in the tree menu.

Returns to the tree menu without changes.

⑤

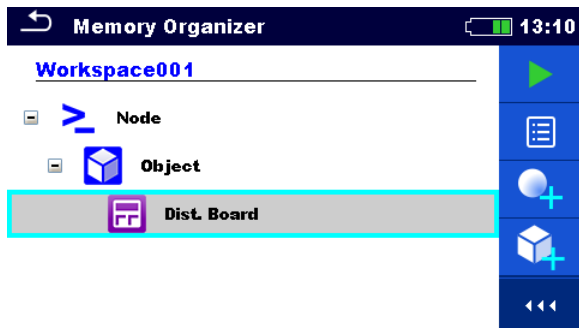

New object added.

### 5.1.5.5 Add a new measurement

In this menu new empty measurements can be set and then added in the structure tree. The type of measurement, measurement function and its parameters are first selected and then added under the selected Structure object.

#### Procedure

- ① 

Select level in structure where measurement will be added.

---

- ② 

Select Add measurement in Control panel.

---

- ③ 

Add new measurement menu.

---

- ③a 

Type of test can be selected from this field.

Options: (Single Tests, Auto Sequences®)

Tap on field or press the  key to modify.

---

- ③b 

Last added measurement is offered by default.

---

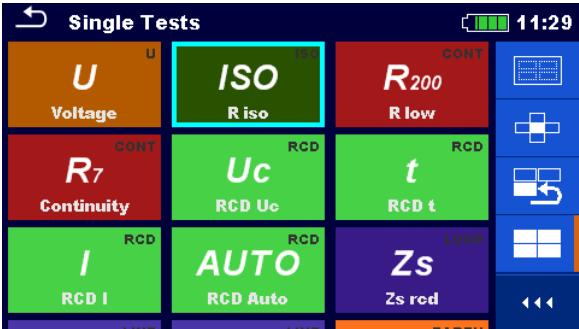
- 

To select another measurement tap on  to open menu for selecting measurements.

---

- ③c 



Select parameter and modify it as described earlier.

Refer to chapter **6.1.2 Setting parameters and limits of single tests** for more information.

④



Adds the measurement under the selected Structure object in the tree menu.



Returns to the structure tree menu without changes.

⑤

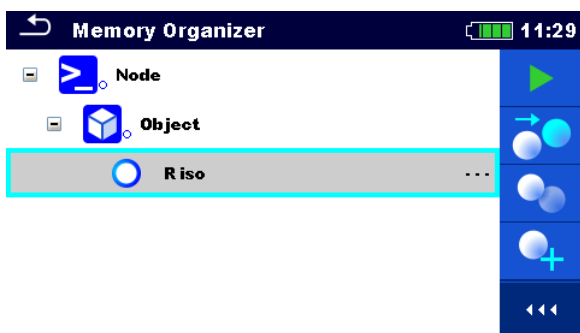

New empty measurement is added under the selected Structure object.

### 5.1.5.6 Clone a Structure object

In this menu selected structure object can be copied (cloned) to same level in the structure tree. Cloned structure object has the same name as the original.

#### Procedure

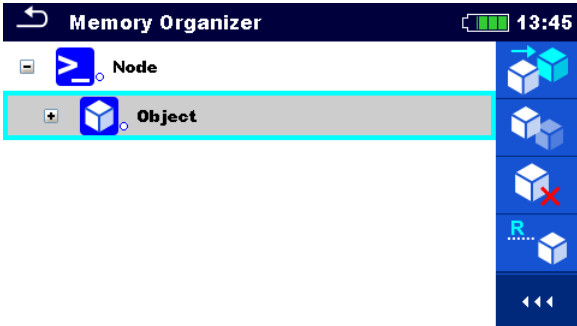
- ① 

Select the structure object to be cloned.

---

- ② 

Select Clone in Control panel.

---

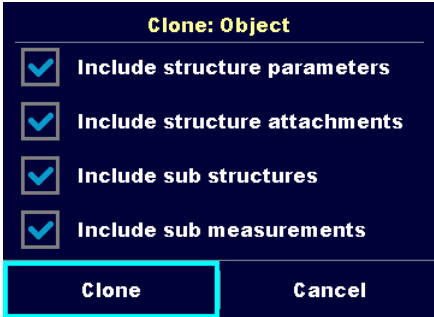
- ③ 

The Clone Structure object menu is displayed. Sub-elements of the selected structure object can be marked or un-marked for cloning.

Refer to chapter **5.1.5.9 Cloning and Pasting sub-elements of selected structure object** for more information.

---

- ④ 



Selected structure object is copied (cloned) to same level in the structure tree.

Cloning is cancelled. No changes in the Structure tree.

---

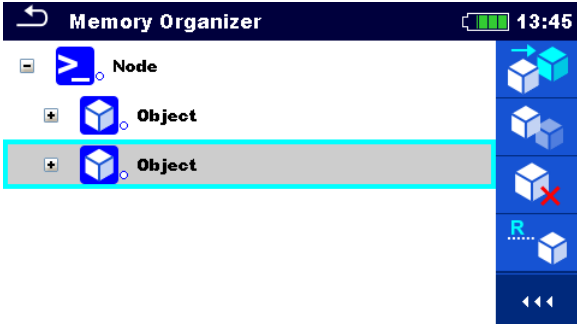
- ⑤ 



The new structure object is displayed.



### 5.1.5.7 Clone a measurement

By using this function a selected empty or finished measurement can be copied (cloned) as an empty measurement to the same level in the structure tree. Parameters and limits of new measurement are the same as they are set in original measurement. Its parameters/limits can be changed when measurement is started.

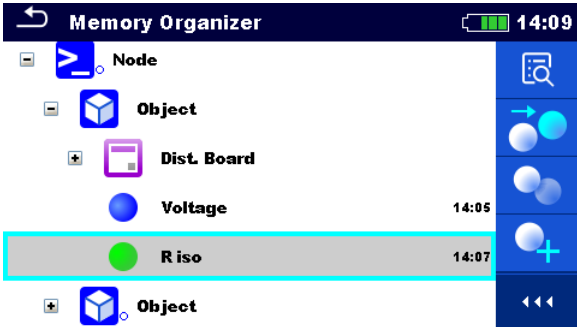
#### Procedure

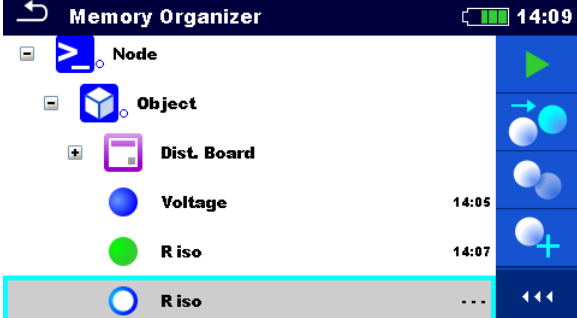
①	 <p>The screenshot shows the 'Memory Organizer' interface with a tree structure. The tree includes a 'Node' containing an 'Object' which contains a 'Dist. Board' with 'Voltage' and 'R iso' sub-items. The 'R iso' item is highlighted with a cyan border. The time displayed is 14:09.</p>	Select the measurement to be cloned.
②	 <p>A close-up of the control panel showing a button with a double-headed arrow icon, representing the 'Clone' function.</p>	Select Clone in Control panel.
③	 <p>The screenshot shows the 'Memory Organizer' interface after cloning. A new 'R iso' measurement is added to the tree, highlighted with a cyan border. The time displayed is 14:09.</p>	A new empty measurement is displayed.

### 5.1.5.8 Copy & Paste a Structure object

In this menu selected Structure object can be copied and pasted to any allowed location in the structure tree.

#### Procedure

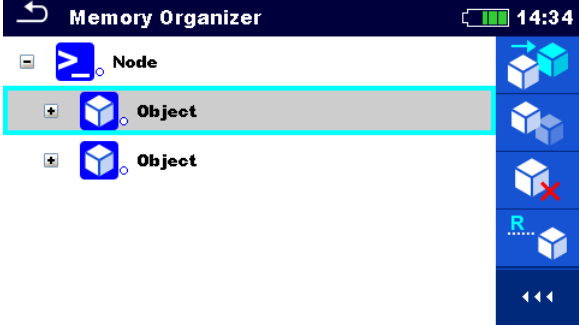
- ① 

Select the structure object to be copied.

---

- ② 

Select Copy in control panel.

---

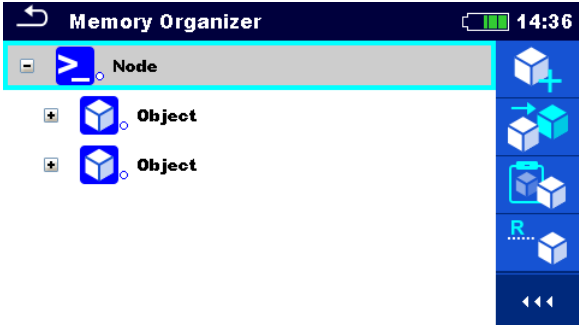
- ③ 

Select location where structure element should be copied.

---

- ④ 

Select Paste in Control panel.

---

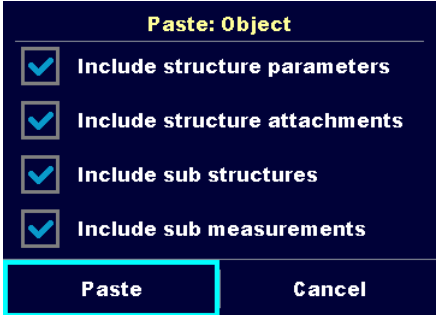
- ⑤ 

The Paste structure object menu is displayed.

Before copying it can be set which sub-elements of the selected structure object will be copied too. Refer to chapter **5.1.5.9 Cloning and Pasting sub-elements of selected structure object** for more information.

---

- ⑥ 

The selected structure object and elements are copied (pasted) to selected position in the tree structure.

Returns to the tree menu without changes.

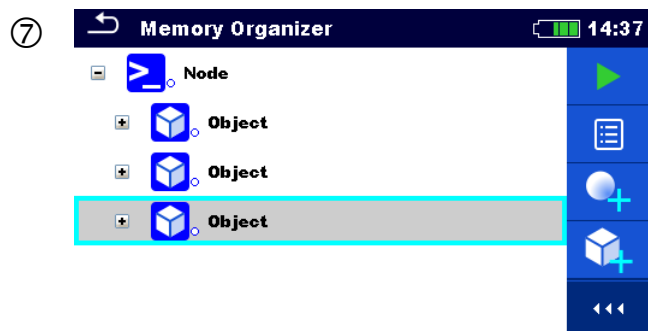

The new structure object is displayed.

**Note**

The Paste command can be executed one or more times.

### 5.1.5.9 Cloning and Pasting sub-elements of selected structure object

When structure object is selected to be cloned, or copied & pasted, additional selection of its sub-elements is needed. The following options are available:

**Options**

<input checked="" type="checkbox"/> <b>Include structure parameters</b>	Parameters of selected structure object will be cloned / pasted too.
<input checked="" type="checkbox"/> <b>Include structure attachments</b>	Attachments of selected structure object will be cloned / pasted too.
<input checked="" type="checkbox"/> <b>Include sub structures</b>	Structure objects in sub-levels of selected structure object will be cloned / pasted too.
<input checked="" type="checkbox"/> <b>Include sub measurements</b>	Measurements in selected structure object and sub-levels will be cloned / pasted too.

### 5.1.5.10 Copy & Paste a measurement

In this menu selected measurement can be copied as an empty measurement to any allowed location in the structure tree. Selected measurement can be copied multiple times to different locations in the structure tree. Parameters and limits of new measurement are the same as they are set in original measurement. Its parameters/limits can be changed when measurement is started.

#### Procedure

- |   |  |  |
|---|--|--|
| ① |  | Select the measurement to be copied.                                 |
| ② |  | Select Copy in Control panel.  |
| ③ |  | Select the location where measurement should be pasted.              |
| ④ |  | Select Paste in Control panel.                                       |
| ⑤ |  | A new (empty) measurement is displayed in selected Structure object. |

**Note**  
The Paste command can be executed one or more times.

### 5.1.5.11 Delete a Structure object

In this menu selected Structure object can be deleted.

#### Procedure

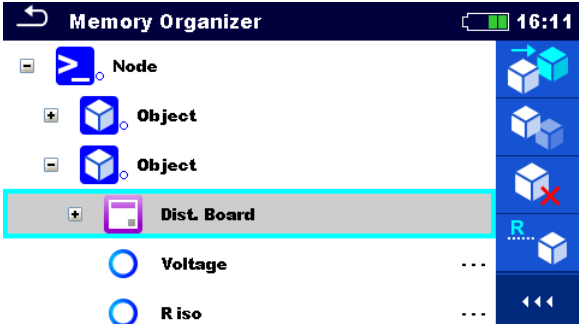
①  Select the structure object to be deleted.

The screenshot shows the 'Memory Organizer' interface. The menu structure is as follows:

- Node
  - Object
    - Object
      - Dist. Board** (highlighted)
      - Voltage
      - R iso

The 'Dist. Board' item is highlighted with a red border. The control panel on the right shows a delete icon (a cube with a red X) which is highlighted.

②  Select Delete in Control panel.

The screenshot shows the control panel with the delete icon (a cube with a red X) highlighted.

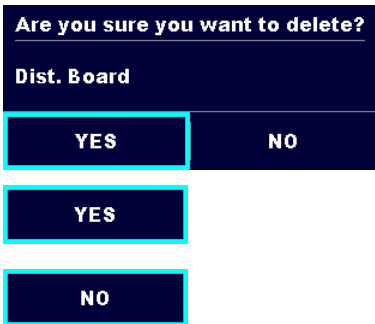
③  A confirmation window will appear.

The screenshot shows a confirmation dialog box with the following content:

Are you sure you want to delete?  
Dist. Board

YES NO

YES

NO

Selected structure object and its sub-elements are removed.

Returns to the tree menu without changes.

④  Structure without deleted object.

The screenshot shows the 'Memory Organizer' interface after the deletion. The menu structure is as follows:



- Node
  - Object
    - Object
      - Voltage
      - R iso
      - R iso

The 'Dist. Board' item has been removed from the menu. The control panel on the right shows the delete icon (a cube with a red X) which is no longer highlighted.

### 5.1.5.12 Delete a measurement

In this menu selected measurement can be deleted from selected location in the tree structure.

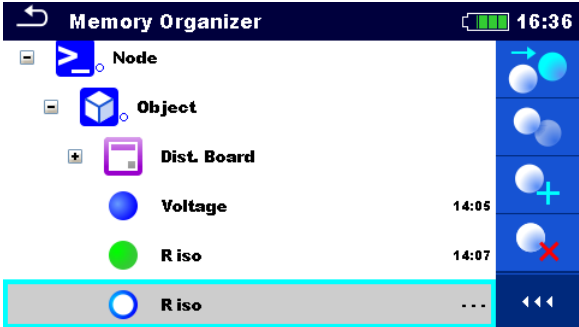
#### Procedure

- ①  Select a measurement to be deleted.
- ②  Select Delete in Control panel.
- ③  A confirmation window will appear.

 Selected measurement is deleted.

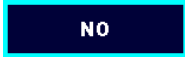
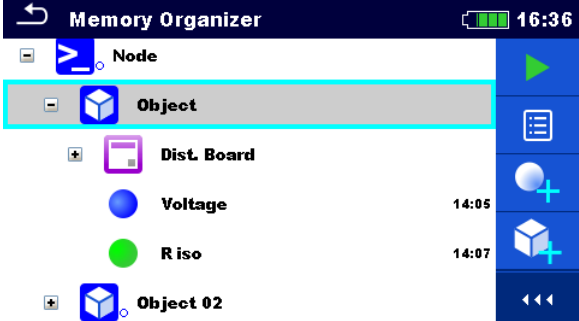
 Returns to the tree menu without changes.
- ④  Structure without deleted measurement.

### 5.1.5.13 Rename a Structure object

In this menu selected Structure object can be renamed.

#### Procedure

①  Select the structure object to be renamed.

The screenshot shows the 'Memory Organizer' application interface. At the top, there is a title bar with a back arrow, the text 'Memory Organizer', a battery icon, and the time '16:14'. Below the title bar, there is a list of items: 'Node' (with a blue cube icon), 'Object' (with a blue cube icon), and another 'Object' (with a blue cube icon). The second 'Object' is highlighted with a cyan border. To the right of the list is a vertical control panel with several icons: a blue cube with a plus sign, a blue cube with a minus sign, a blue cube with a red 'X', a blue cube with an 'R' and a plus sign, and a blue double arrow icon.

②  Select Rename in Control panel.

The screenshot shows a close-up of the control panel, specifically the 'Rename' option, which is represented by a blue cube icon with a white 'R' and a plus sign.

③  Virtual keypad will appear on screen. Enter new text and confirm.

Refer to chapter 4.3 *Virtual keyboard* for keypad operation.

The screenshot shows the virtual keypad interface. At the top, there is a title bar with a back arrow, the text 'Memory Organizer', a battery icon, and the time '16:14'. Below the title bar, there is a text input field with the label 'Name' and the text 'Object 02'. Below the text input field is a virtual keypad with a grid of buttons. The buttons include numbers 1-0, symbols like !, @, #, \$, %, &, \*, ?, /, shift, \_ ' " ' ( ) - +, and a back arrow. The '2' button is highlighted in cyan.

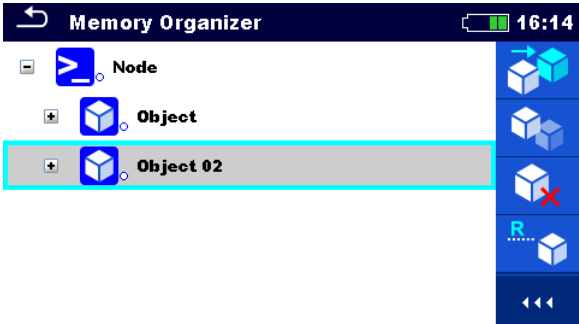
④  Structure object with the modified name.

The screenshot shows the 'Memory Organizer' application interface after the rename operation. The title bar is the same as in step 1. The list of items now includes 'Node', 'Object', and 'Object 02'. The 'Object 02' is highlighted with a cyan border. The control panel is the same as in step 1.

### 5.1.5.14 Recall and Retest selected measurement

#### Procedure

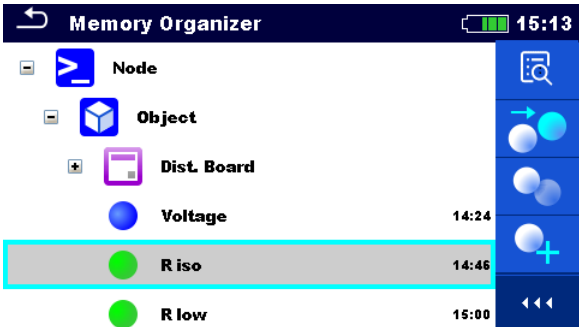
①  Select the measurement to be recalled.

②  Select Recall results in Control panel.

③  Measurement is recalled.

③a  Parameters and limits can be viewed but cannot be edited.

④  Select Retest in Control panel.

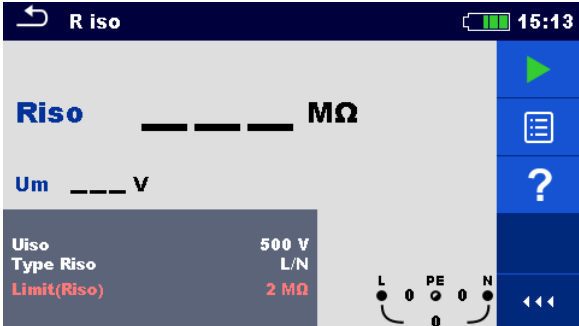
⑤  Measurement retest starting screen is displayed.



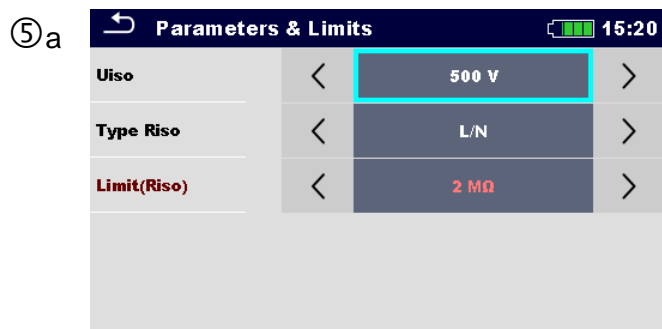

Parameters and limits can be viewed and edited.



Select Run in Control panel to retest the measurement.

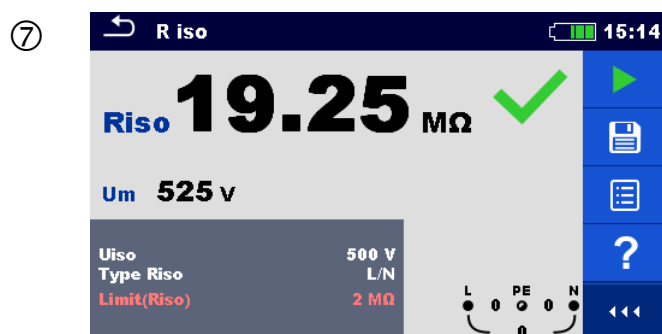

Results / sub-results after re-run of recalled measurement.



Select Save results in Control panel.

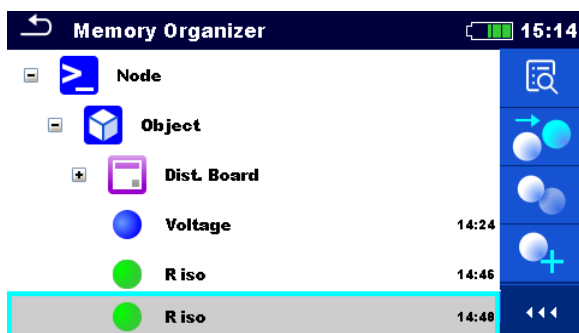

Retested measurement is saved under same structure object as original one.  
Refreshed memory structure with the new performed measurement.

### 5.1.6 Searching in Memory Organizer

In Memory organizer it is possible to search for different structure objects and parameters. Search function is available from the active workspace directory line as presented on **Figure 5.6**.

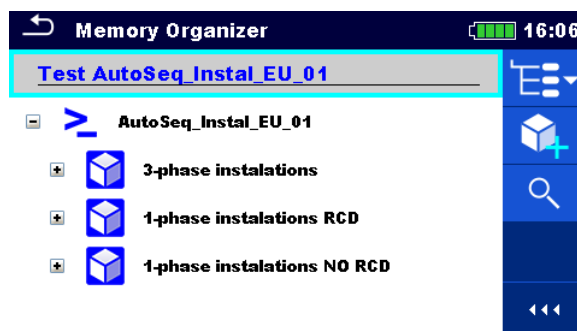
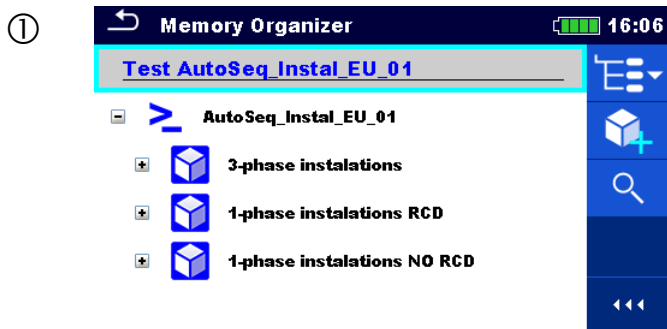

Figure 5.6: Active workspace directory

Procedure



Search function is available from the active workspace directory line.



Select Search in control panel to open Search setup menu.

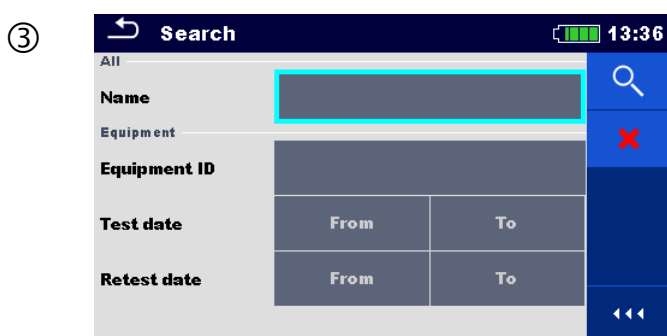

The parameter that can be searched for is displayed in the search setup menu. Name is referred to all structure objects. Equipment ID, Test date and Retest date are referred to Machine structure objects.



The search can be narrowed by entering a text in the Name and/or Equipment ID field.

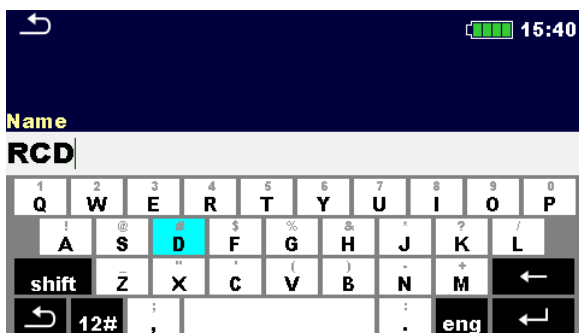

Strings can be entered using the on-screen keyboard.

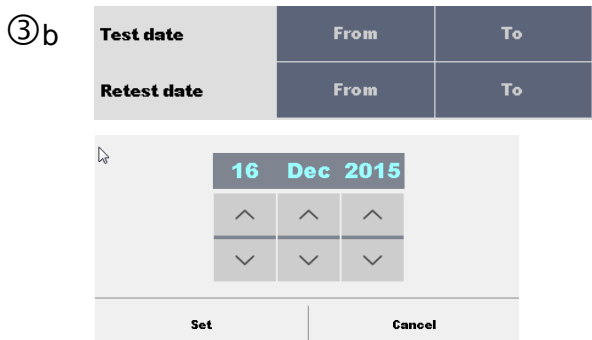

The search can be narrowed on base of test dates / retest dates (from / to).



Clears filters.

④



Searches through the Memory Organizer for objects according to the set filter. The results are shown in the Search results screen presented on **Figure 5.7**.

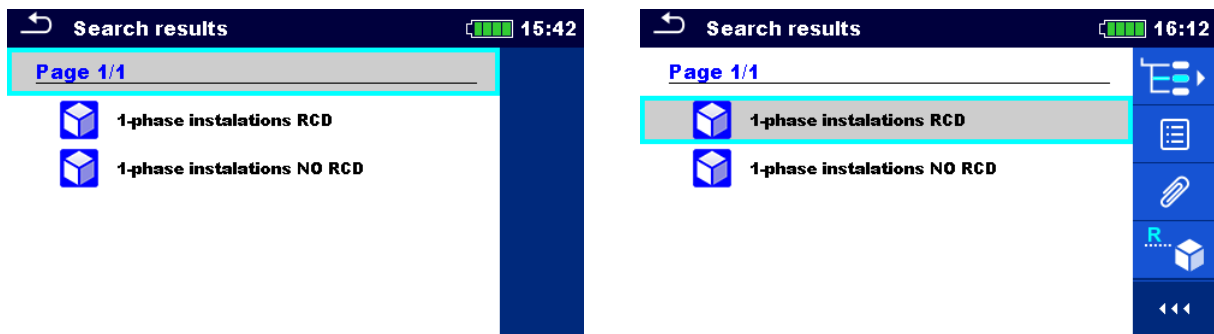

**Figure 5.7: Search results screen (left), structure object selected (right)**

#### Options



Next page (if available).



Previous page (if available).



Goes to location in Memory Organizer.



View / edit parameters and attachments.

Parameters and attachments of the Structure object can be viewed or edited. Refer to chapter **5.1.5.3 View / Edit parameters and attachments of a Structure object** for more information.



Attachments.

Name and link of attachment is displayed.



Views comment.

The instrument displays comment attached to the selected Structure object.



Renames the selected Structure object.

Refer to chapter **5.1.5.13 Rename a Structure object** for more information

#### Note:

- › Search result page consist of up to 50 results.

## 6 Single tests

Single tests can be selected in the main **Single tests** menu or in **Memory organizer** main menu and sub-menus.

### 6.1 Selection modes

In **Single test main menu** four modes for selecting single tests are available.

#### Options



#### Area Group

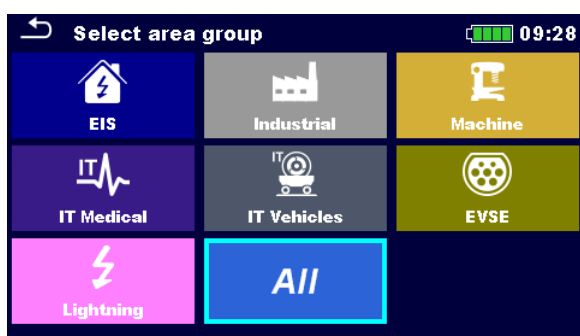

With help of area groups it is possible to limit the offered single tests. The instrument has several area groups:

- ▶ the EIS group,
- ▶ the Industrial group,
- ▶ the Machine group,
- ▶ the IT Medical group,
- ▶ the IT Vehicles group,
- ▶ the EVSE group,
- ▶ the Lightning group.

In the All group all measurements are offered.



#### Groups

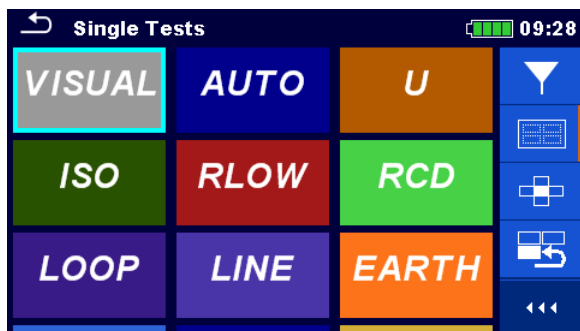

The single tests are divided into groups of similar tests.

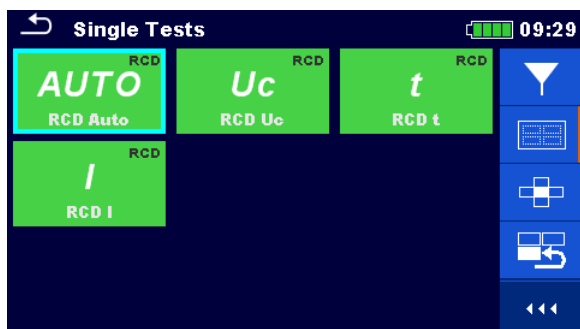

For the selected group a submenu with all single tests that belongs to the selected group is displayed.



### Cross selector

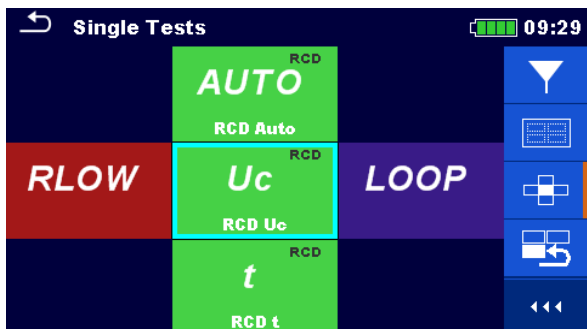

This selection mode is the fastest for working with the keypad.

Groups of single tests are organized in a row.

For the selected group all single tests are displayed and easy accessible with up /down keys.



### Last used

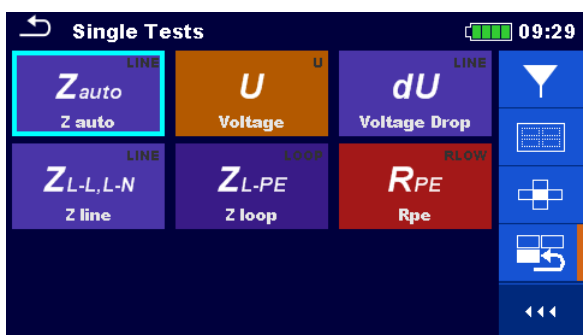

Last 9 made different single tests are displayed.



Expands control panel / open more options.

## 6.1.1 Single test (measurement) screens

In the Single test (measurement) screens measuring results, sub-results, limits and parameters of the measurement are displayed. In addition on-line statuses, warnings and other info are displayed.

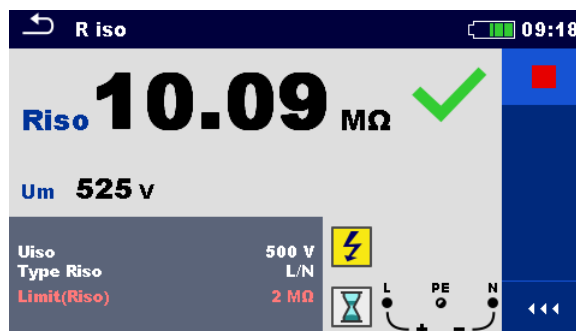
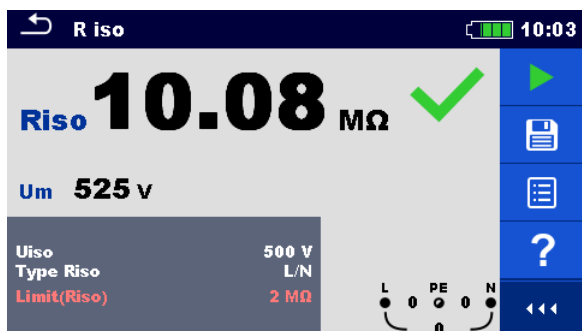

Figure 6.1: Single test screen organization, example of insulation resistance measurement

### Single test screen organization



Header line:

- ▶ ESC touch key

- › function name
- › battery status
- › real time clock

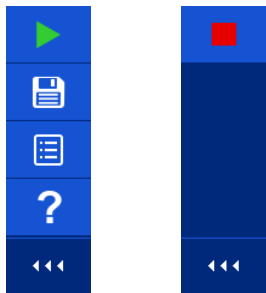

Control panel (available options)



Parameters (white) and limits (red)



Result field:

- › main result(s)
- › sub-result(s)
- › PASS / FAIL indication



Voltage monitor with info and warning symbols

### 6.1.2 Setting parameters and limits of single tests

**Procedure**

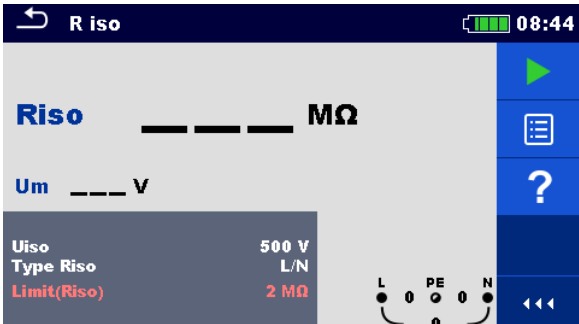
①  Select the test or measurement.  
 The test can be entered from:

- Single tests menu or
- Memory organizer menu once the empty measurement was created in selected object structure.

②  Select Parameters in Control panel.

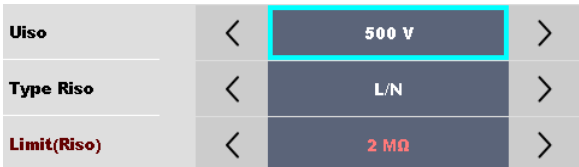
③  Select parameter to be edited or limit to be set.

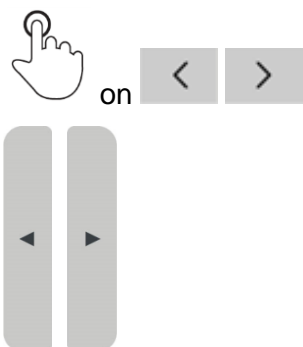

Set parameter or limit value.

③a  Enters Set value menu.

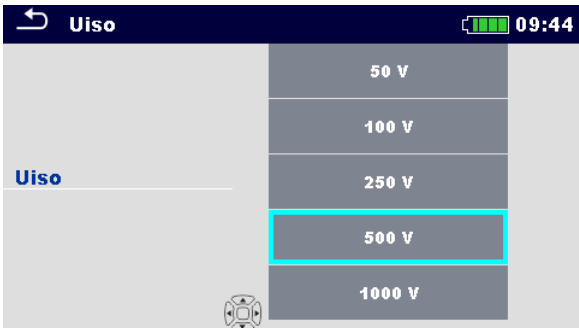

③b  Set value menu.

③c  Accepts a new parameter or limit value and exits.



④



Accepts the new parameters and limit values and exits.



### 6.1.3 Single test start screen

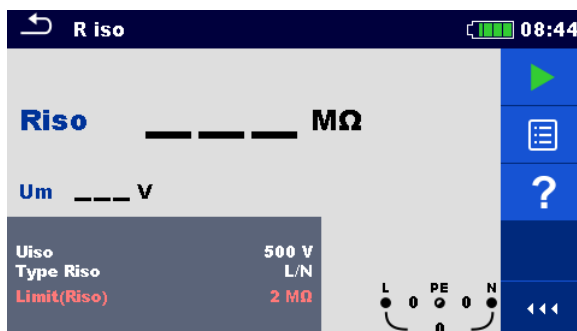

Figure 6.2: Single test start screen, example of insulation resistance measurement

Options (before test, screen was opened in Memory organizer or Single test main menu):



Starts the measurement.



long

Starts the continuous measurement (if applicable on selected single test).



long



Opens help screens.



Opens menu for changing parameters and limits. Refer to chapter **6.1.2 Setting parameters and limits of single tests** for more information.



on



long on

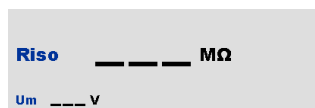

Enters cross selector to select test or measurement.



Expands column in control panel.





### 6.1.4 Single test screen during test

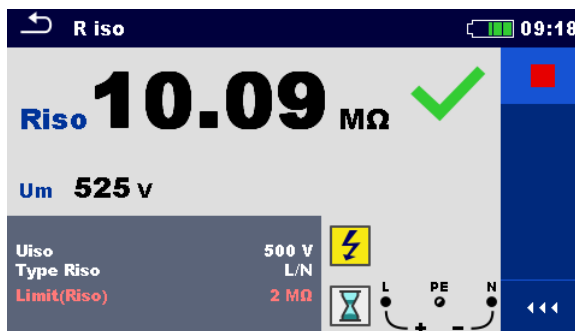











Figure 6.3: Single test is running, example of insulation resistance continuous measurement

Operations when test is running:

		Stops the single test measurement.
		Proceeds to next step of the measurement (if measurement consists of more steps).
		Previous value.
		Next value.
		Stops or aborts the measurement and returns one menu back.

## 6.1.5 Single test result screen

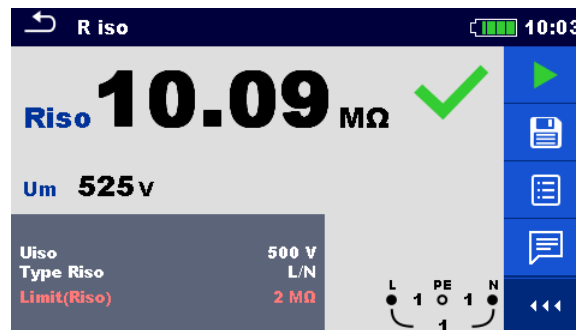

Figure 6.4: Single test results screen, example of insulation resistance measurement results

### Options (after measurement is finished)



Starts a new measurement.



long

Starts a new continuous measurement (if applicable on selected single test).



long



Saves the result.



A new measurement was selected and started from a Structure object in the structure tree:

- › the measurement will be saved under the selected Structure object.

A new measurement was started from the Single test main menu:

- › saving under the last selected Structure object will be offered by default. The user can select another Structure object or create a new Structure object.
- › By pressing the  key in Memory organizer menu the measurement is saved under selected location.

An empty measurement was selected in structure tree and started:

- › the result(s) will be added to the measurement. The measurement will change its status from 'empty' to 'finished'.

An already carried out measurement was selected in structure tree, viewed and then restarted:

- a new measurement will be saved under the selected Structure object.



Opens screen for changing parameters and limits.  
Refer to chapter **6.1.2 Setting parameters and limits of single tests** for more information.



on



Adds comment to the measurement. The instrument opens keypad for entering a comment.



Opens help screens.



long on



Enters cross selector to select test or measurement.



Expands column in control panel.



### 6.1.6 Editing graphs (Harmonics)

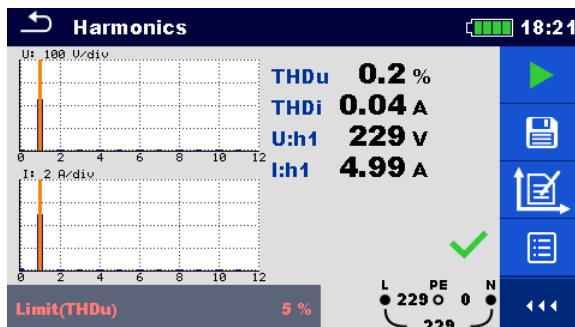

Figure 6.5: Example of Harmonics measurement results

#### Options for editing graphs (start screen or after measurement is finished)



Plot edit  
Opens control panel for editing graphs.



Increase scale factor for y-axis.



Decrease scale factor for y-axis.



Toggle between U and I graph to set scale factor



Exits from editing graphs.



### 6.1.7 Single test (inspection) screens

Visual and Functional inspections can be treated as a special class of tests. Items to be visually or functionally checked are displayed. In addition on-line statuses and other information are displayed. Type of inspection depends on type and profile of the instruments.

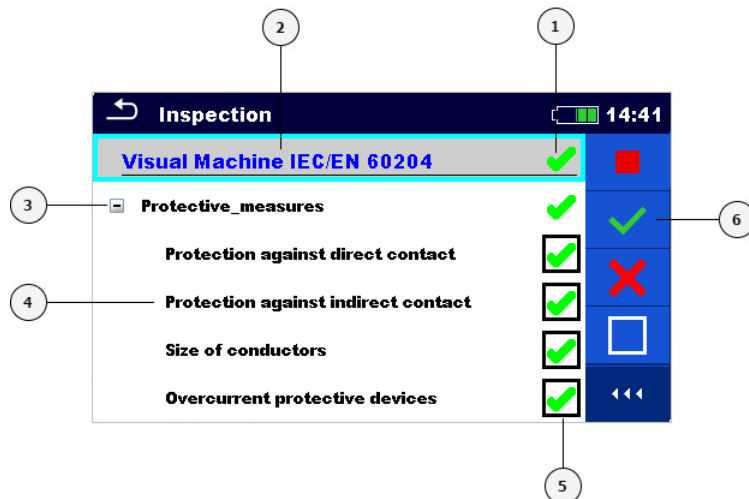

Figure 6.6: Inspection screen organisation

#### Legend

- 1 Overall status of the inspection
- 2 Selected inspection
- 3 Item
- 4 Child items
- 5 Status fields (for items and child items)
- 6 Control panel (available options)

#### 6.1.7.1 Single test (inspection) start screen

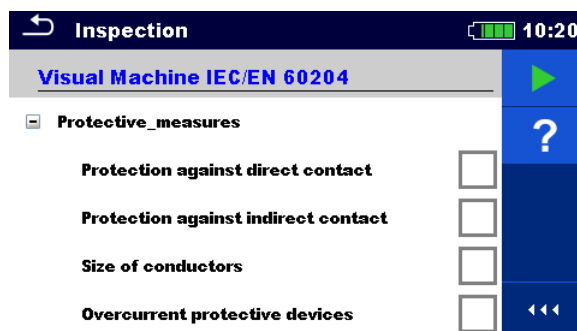

Figure 6.7: Inspection start screen

Options (inspection screen was opened in Memory organizer or from Single test main menu)

- ▶ Starts the inspection.
- ? Opens help screens. Refer to chapter **6.1.8 Help screens** for more information.

### 6.1.7.2 Single test (Inspection) screen during test



Figure 6.8: Inspection screen (during inspection)

#### Options (during test)

- Visual Machine IEC/EN 60204

Selects item.
- Protective\_measures
- Protection against indirect contact
- Stops the inspection.
- ✓

Applies a pass to the selected item or group of items.
- ✗

Applies a fail to the selected item or group of items.
- Clears status in selected item or group of items
- Applies checked status to selected item or group of items.
- on

A status can be applied  
Multiple taps toggles between statuses.
- Toggle between statuses.
- ↶

Goes to the result screen.
- ↶

**Rules for automatic applying of statuses:**

- › The parent item(s) can automatically get a status on base of statuses in child items.
  - › the fail status has highest priority. A fail status for any item will result in a fail status in all parent items and an overall fail result.
  - › if there is no fail status in child items the parent item will get a status only if all child items have a status.
  - › Pass status has priority over checked status.
- › The child item(s) will automatically get a status on base of status in the parent item.
  - › All child items will get the same status as applied to the parent item.

**Notes:**

- › Inspections and even inspection items inside one inspection can have can have different status types. For example some basic inspections don't have the 'checked' status.
- › Only inspections with overall statuses can be saved.

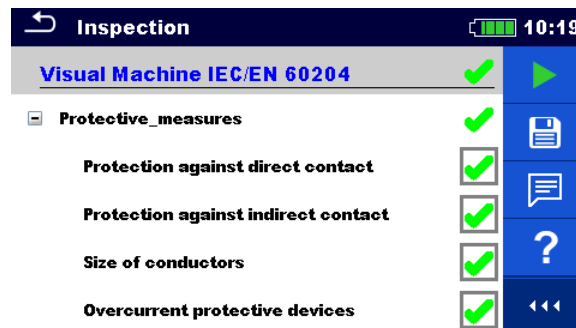
**6.1.7.3 Single test (Inspection) result screen****Figure 6.9: Inspection result screen****Options (after inspection is finished)**

Starts a new inspection.



Saves the result.

A new inspection was selected and started from a Structure object in the structure tree:

- › The inspection will be saved under the selected Structure object.

A new inspection was started from the Single test main menu:

- › Saving under the last selected Structure object will be offered by default. The user can select another Structure object or create a new Structure object. By

pressing the  key in Memory organizer menu the inspection is saved under selected location.

An empty inspection was selected in structure tree and started:

- › The result(s) will be added to the inspection. The inspection will change its status from 'empty' to 'finished'.

An already carried out inspection was selected in structure tree, viewed and then restarted:

- A new measurement will be saved under the selected Structure object.



Adds comment to the measurement. The instrument opens keypad for entering a comment.



Opens help screens. Refer to chapter **6.1.8 Help screens** for more information.

#### 6.1.7.4 Single test (inspection) memory screen

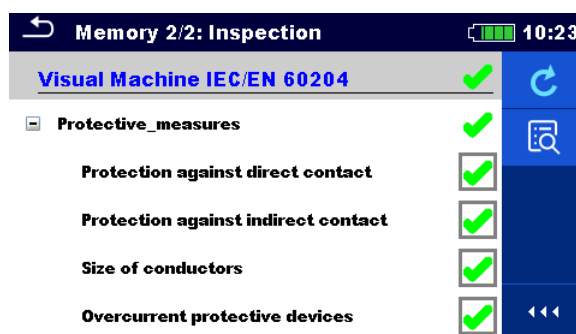

Figure 6.10: Inspection memory screen

#### Options



#### Retest

Enters screen with 'empty' measurement.



Enters view mode.



### 6.1.8 Help screens

Help screens contain diagrams for proper connection of the instrument.

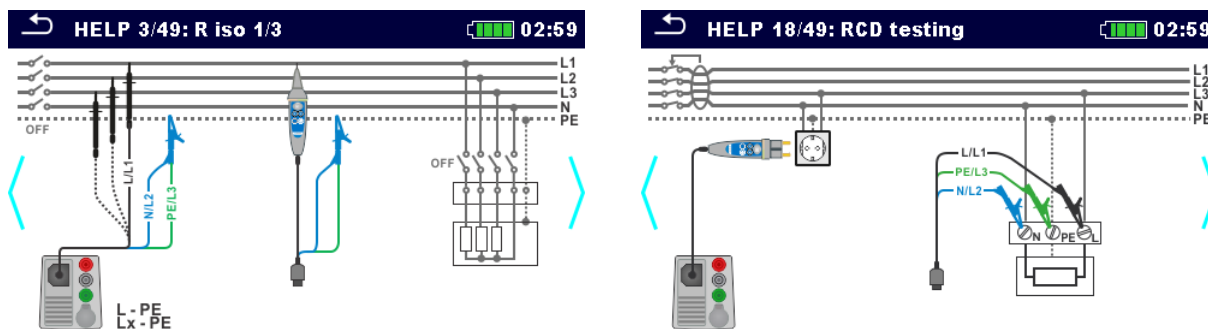

Figure 6.11: Examples of help screens

#### Options



Opens help screen.



Goes to previous / next help screen.



Back to test / measurement menu.



### 6.1.9 Recall single test results screen

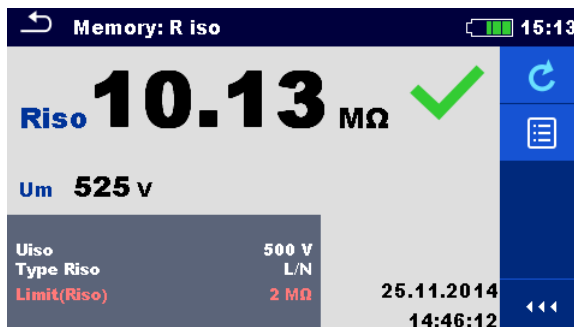

Figure 6.12: Recalled results of selected measurement, example of insulation resistance recalled results

#### Options



Retest  
 Enters starting screen for a new measurement.  
 Refer to chapter **6.1.3 Single test start screen** for more information.



Opens menu for viewing parameters and limits.  
 Refer to chapter **6.1.2 Setting parameters and limits of single tests** for more information.



on



Expands column in control panel.



## 7 Tests and measurements

See chapter 6.1 *Selection modes* for instructions on keys and touch screen functionality.

### 7.1 Voltage, frequency and phase sequence



Figure 7.1: Voltage measurement menu

#### Measurement parameters

System <sup>1)</sup>	Voltage system [-, 1-phase,3-phase]
Limit type	Type of limit [Voltage, %]
Earthing system	Earthing system [TN/TT, IT]
Nominal voltage <sup>2)</sup>	Nominal voltage [110 V, 115 V, 190 V, 200 V, 220 V, 230 V, 240 V, 380 V, 400 V, 415 V]

<sup>1)</sup> There is no limits to set if System parameter is set to '-'.  
<sup>2)</sup> Active only if limit type parameter is set to %.

Refer to chapter 4.6.8 *Settings* for more information.

#### Measurement limits for TN/TT earthing system:

Low limit Uln <sup>3)</sup>	Min. voltage [0 V ... 499 V]
High limit Uln <sup>3)</sup>	Max. voltage [0 V ... 499 V]
Low limit Uln <sup>4)</sup>	Min. voltage [-20% ... 20%]
High limit Uln <sup>4)</sup>	Max. voltage [-20% ... 20%]
Low limit Ulpe <sup>3,4)</sup>	Min. voltage [0 V ... 499 V]
High limit Ulpe <sup>3,4)</sup>	Max. voltage [0 V ... 499 V]
Low limit Unpe <sup>3,4)</sup>	Min. voltage [0 V ... 499 V]
High limit Unpe <sup>3,4)</sup>	Max. voltage [0 V ... 499 V]
Low limit U12 <sup>5)</sup>	Min. voltage [0 V ... 499 V]
High limit U12 <sup>5)</sup>	Max. voltage [0 V ... 499 V]
Low limit U13 <sup>5)</sup>	Min. voltage [0 V ... 499 V]
High limit U13 <sup>5)</sup>	Max. voltage [0 V ... 499 V]
Low limit U23 <sup>5)</sup>	Min. voltage [0 V ... 499 V]
High limit U23 <sup>5)</sup>	Max. voltage [0 V ... 499 V]
Low limit UII <sup>6)</sup>	Min. voltage [-20% ... 20%]
High limit UII <sup>6)</sup>	Max. voltage [-20% ... 20%]

<sup>3)</sup> In case of 1-phase voltage system and limit type set to voltage.

<sup>4)</sup> In case of 1-phase voltage system and limit type set to %.

<sup>5)</sup> In case of 3-phase voltage system and limit type set to voltage.

<sup>6)</sup> In case of 3-phase voltage system and limit type set to %.

Measurement limits for IT earthing system:

Low limit U12 <sup>7,9)</sup>	Min. voltage [0 V ... 499 V]
High limit U12 <sup>7,9)</sup>	Max. voltage [0 V ... 499 V]
Low limit U12 <sup>8)</sup>	Min. voltage [-20% ... 20%]
High limit U12 <sup>8)</sup>	Max. voltage [-20% ... 20%]
Low limit U1pe <sup>7,8)</sup>	Min. voltage [0 V ... 499 V]
High limit U1pe <sup>7,8)</sup>	Max. voltage [0 V ... 499 V]
Low limit U2pe <sup>7,8)</sup>	Min. voltage [0 V ... 499 V]
High limit U2pe <sup>7,8)</sup>	Max. voltage [0 V ... 499 V]
Low limit U13 <sup>9)</sup>	Min. voltage [0 V ... 499 V]
High limit U13 <sup>9)</sup>	Max. voltage [0 V ... 499 V]
Low limit U23 <sup>9)</sup>	Min. voltage [0 V ... 499 V]
High limit U23 <sup>9)</sup>	Max. voltage [0 V ... 499 V]
Low limit UII <sup>10)</sup>	Min. voltage [-20% ... 20%]
High limit UII <sup>10)</sup>	Max. voltage [-20% ... 20%]

- 7) In case of 1-phase voltage system and limit type set to voltage.
- 8) In case of 1-phase voltage system and limit type set to %.
- 9) In case of 3-phase voltage system and limit type set to voltage.
- 10) In case of 3-phase voltage system and limit type set to %.

Connection diagrams

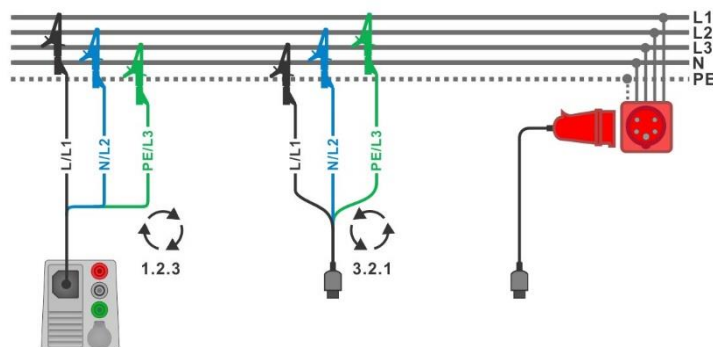

Figure 7.2: Connection of 3-wire test lead and optional adapter in three-phase system

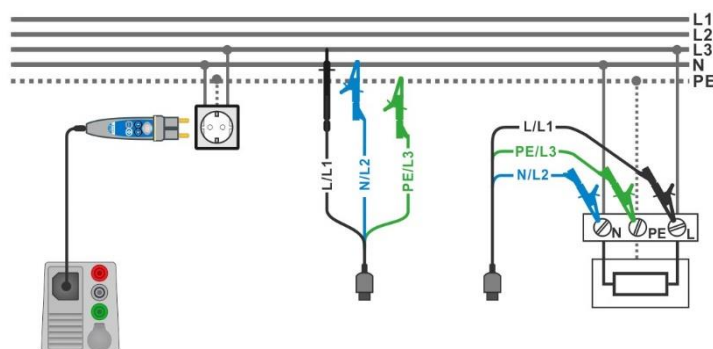

Figure 7.3: Connection of Plug commander and 3-wire test lead in single-phase system

## Measurement procedure

- › Enter the **Voltage** function.
- › Set test parameters / limits.
- › Connect test cable to the instrument.
- › Connect test leads to object under test (see *Figure 7.2* and *Figure 7.3*).
- › Start the continuous measurement.
- › Stop the measurement.
- › Save results (optional).

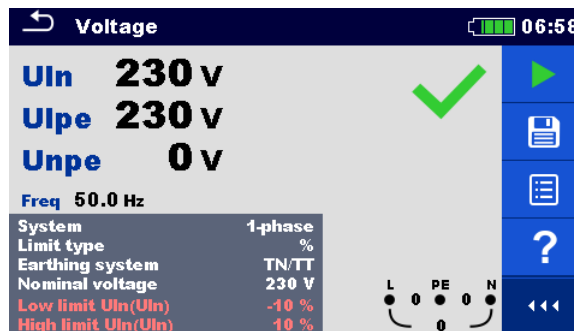

Figure 7.4: Example of Voltage measurement results in single-phase system

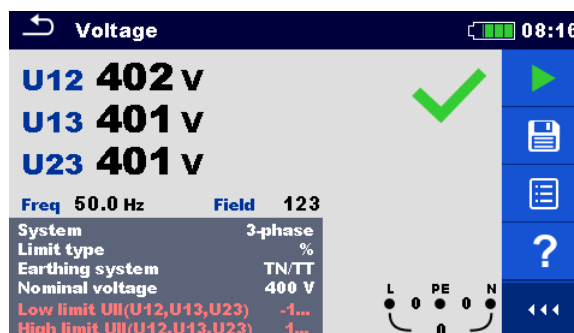

Figure 7.5: Example of Voltage measurement results in three-phase system

## Measurement results / sub-results

Single-phase TN/TT system:

<b>Uln</b>	Voltage between phase and neutral conductors
<b>Ulpe</b>	voltage between phase and protective conductors
<b>Unpe</b>	voltage between neutral and protective conductors
<b>Freq</b>	frequency

Single phase IT system:

<b>U12</b>	voltage between phases L1 and L2
<b>U1pe</b>	voltage between phase L1 and PE
<b>U2pe</b>	voltage between phase L2 and PE
<b>Freq</b>	frequency

Three-phase TN/TT and IT system:

---

<b>U12</b>	voltage between phases L1 and L2
<b>U13</b>	voltage between phases L1 and L3
<b>U23</b>	voltage between phases L2 and L3
<b>Freq</b>	frequency
<b>Field</b>	<b>1.2.3</b> - correct connection – CW rotation sequence <b>3.2.1</b> - invalid connection – CCW rotation sequence

---

## 7.2 R iso – Insulation resistance

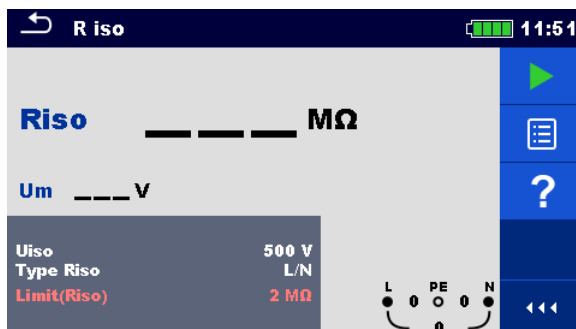

Figure 7.6: Insulation resistance measurement menu

### Measurement parameters / limits

<b>Uiso</b>	<b>Nominal test voltage</b> [50 V, 100 V, 250 V, 500 V, 1000 V, 2500 V]
<b>Type Riso<sup>1)</sup></b>	<b>Type of test</b> [-, L/PE, L/N, N/PE, L/L, L1/L2, L1/L3, L2/L3, L1/N, L2/N, L3/N, L1/PE, L2/PE, L3/PE]
<b>Limit(Riso)</b>	<b>Min. insulation resistance</b> [Off, 0.01 MΩ ... 100 MΩ]

<sup>1)</sup> Insulation measurement depends on Type Riso parameter setting, see table below.

Type Riso parameter	3-wire test lead and Tip commander measuring terminals (U <sub>N</sub> ≤ 1 kV)	2.5 kV test lead measuring terminals (U <sub>N</sub> = 2.5 kV)
-		
L-N		
Lx-N	L and N	
L/L		
Lx-Ly		HV+ and HV-
L-PE	L and PE	
Lx-PE		
N-PE	N and PE	

**Table 7.1: Insulation resistance measuring terminals and Type Riso parameter dependency**

Connection diagrams

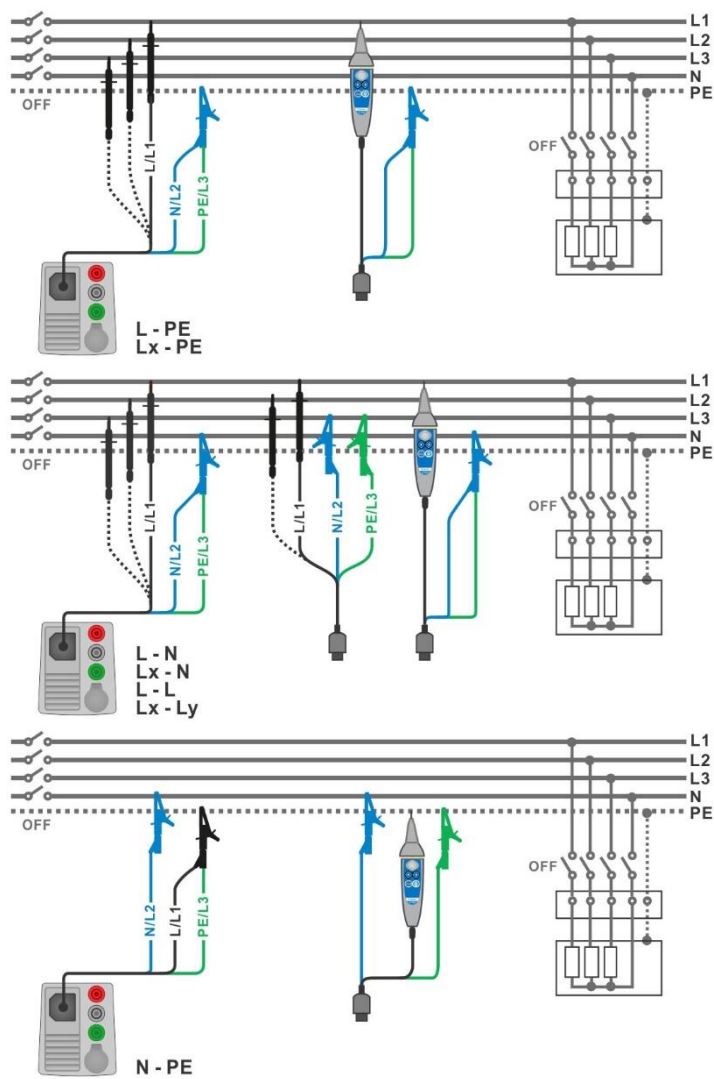

Figure 7.7: Connections of 3-wire test lead and Tip commander ( $U_N \leq 1$  kV)

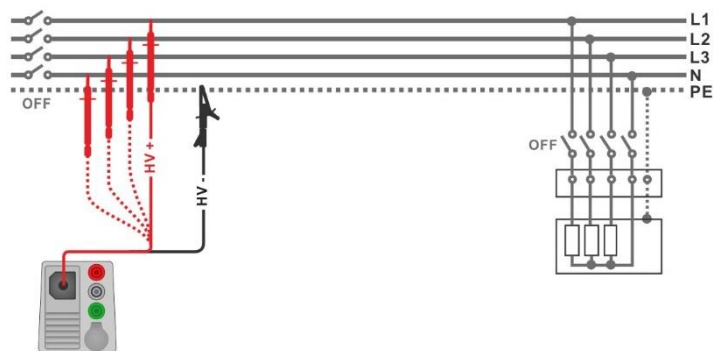

Figure 7.8: Connection of 2.5 kV test lead ( $U_N = 2.5$  kV)



## Measurement procedure

- › Enter the **R iso** function.
- › Set test parameters / limits.
- › Disconnect tested installation from mains supply and discharge installation as required.
- › Connect test cable to the instrument.
- › Connect test leads to object under test (see **Figure 7.7** and **Figure 7.8**).  
Different test cable must be used for testing with nominal test voltage  $U_N \leq 1000$  V and  $U_N = 2500$  V. Also different test terminals are used.  
The standard 3-wire test lead, Schuko test cable or Plug / Tip commanders can be used for the insulation test with nominal test voltages  $\leq 1000$  V.  
For the 2500 V insulation test the two wire 2.5 kV test lead should be used.
- › Start the measurement. A longer press on  key or a longer press on 'Start test' option on touch screen starts a continuous measurement.
- › Stop the measurement. Wait until object under test is fully discharged.
- › Save results (optional).



Figure 7.9: Examples of Insulation resistance measurement result

## Measurement results / sub-results

**Riso** Insulation resistance

**Um** Actual test voltage

## 7.3 R iso all – Insulation resistance

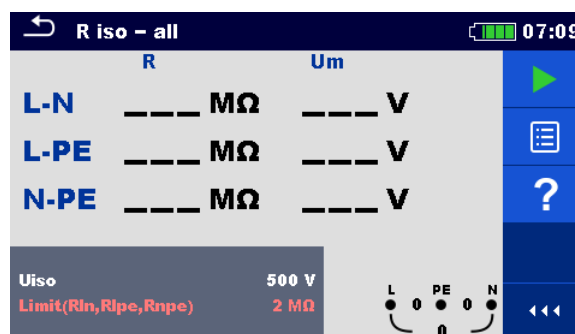

Figure 7.10: R iso - all measurement menu

## Measurement parameters / limits

**Uiso** Nominal test voltage [50 V, 100 V, 250 V, 500 V, 1000 V]

**Limit** Min. insulation resistance [Off, 0.01 MΩ ... 100 MΩ]

Insulation is always measured between all three test leads.

Connection diagrams

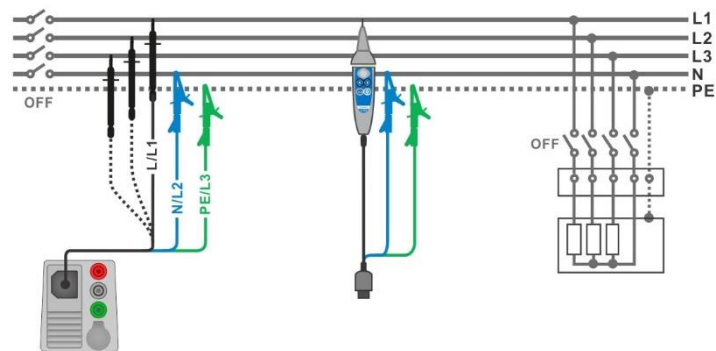

Figure 7.11: Connection of 3-wire test lead and Tip commander

Measurement procedure

- › Enter the **R iso - all** function.
- › Set test parameters / limits.
- › Disconnect tested installation from mains supply and discharge installation as required.
- › Connect test cable to the instrument.
- › Connect test leads to object under test (see **Figure 7.11**).  
The standard 3-wire test lead, Schuko test cable or Plug / Tip commanders can be used.
- › Start the measurement.
- › Wait until object under test is fully discharged.
- › Save results (optional).

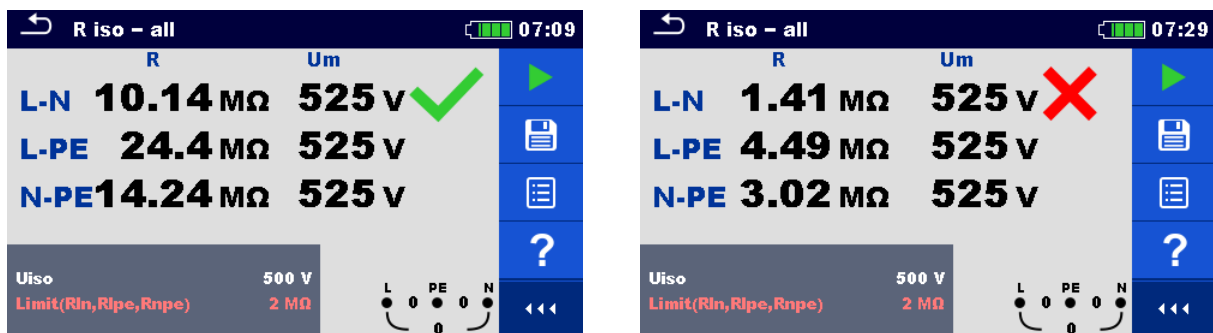

Figure 7.12: Examples of R iso - all measurement result

Measurement results / sub-results

Riso	L-N	Insulation resistance between L and N terminals
	L-PE	Insulation resistance between L and PE terminals
	N-PE	Insulation resistance between N and PE terminals
Um	L-N	Actual test voltage between L and N terminals
	L-PE	Actual test voltage between L and PE terminals
	N-PE	Actual test voltage between N and PE terminals

### 7.4 The DAR and PI diagnostic

**DAR** (**D**ielectric **A**bsorption **R**atio) is ratio of insulation resistance values measured after 15 seconds and after 1 minute. The DC test voltage is present during the whole period of the measurement.

$$DAR = \frac{R_{ISO}(1 \text{ min})}{R_{ISO}(15 \text{ s})}$$

**PI** (**P**olarization **I**ndex) is the ratio of insulation resistance values measured after 1 minute and after 10 minutes. The DC test voltage is present during the whole period of the measurement

$$PI = \frac{R_{ISO}(10 \text{ min})}{R_{ISO}(1 \text{ min})}$$

For additional information regarding PI and DAR diagnostic, please refer to Metrel’s handbook **Modern insulation testing**.

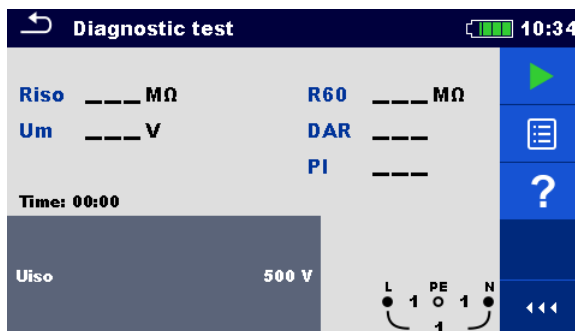

Figure 7.13: Diagnostic test menu

#### Measurement parameters / limits

Uiso	Nominal test voltage [500 V, 1000 V, 2500 V]
------	--

#### Connection diagrams

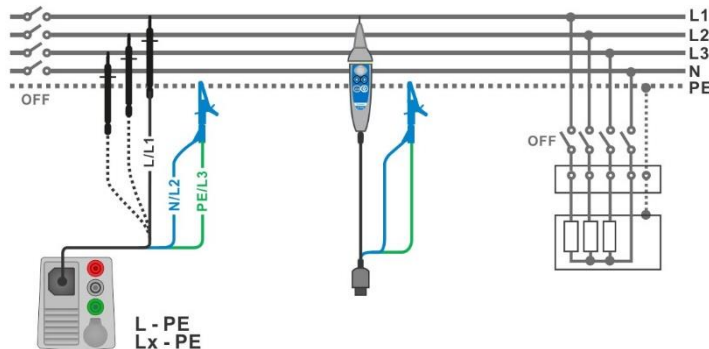

Figure 7.14: Connection of 3-wire test lead and Tip commander ( $U_N \leq 1 \text{ kV}$ )

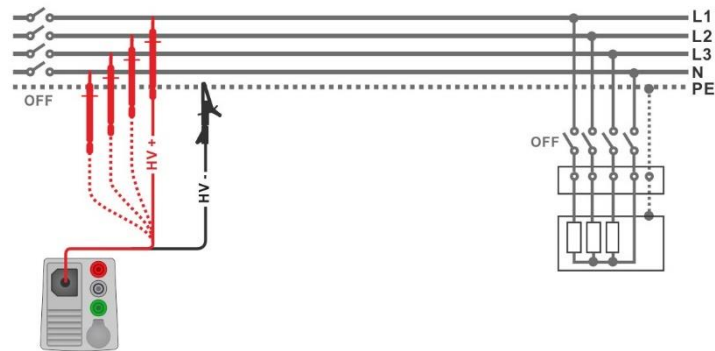

Figure 7.15: Connection of 2.5 kV test lead ( $U_N = 2.5 \text{ kV}$ )

### Measurement procedure

- ▶ Enter the **Diagnostic test** function.
- ▶ Set test parameters / limits.
- ▶ Disconnect tested installation from mains supply and discharge installation as required.
- ▶ Connect test cable to the instrument.
- ▶ Connect test leads to object under test (see **Figure 7.14** and **Figure 7.15**).  
Different test cable must be used for testing with nominal test voltage  $U_N \leq 1000 \text{ V}$  and  $U_N = 2500 \text{ V}$ . Also different test terminals are used.  
The standard 3-wire test lead, Schuko test cable or Plug / Tip commanders can be used for the diagnostic test with nominal test voltages  $\leq 1000 \text{ V}$ . For the 2500 V diagnostic test the two wire 2.5 kV test lead should be used.
- ▶ Start the measurement. Internal timer begins to increment. When internal timer reaches 1 min R60 and DAR factor are displayed and short beep is generated. Measurement can be interrupted at any time.
- ▶ When internal timer reaches 10 min also PI factor is displayed and measurement is completed. Wait until object under test is fully discharged.
- ▶ After the measurement is finished wait until tested item is fully discharged.
- ▶ Save results (optional).

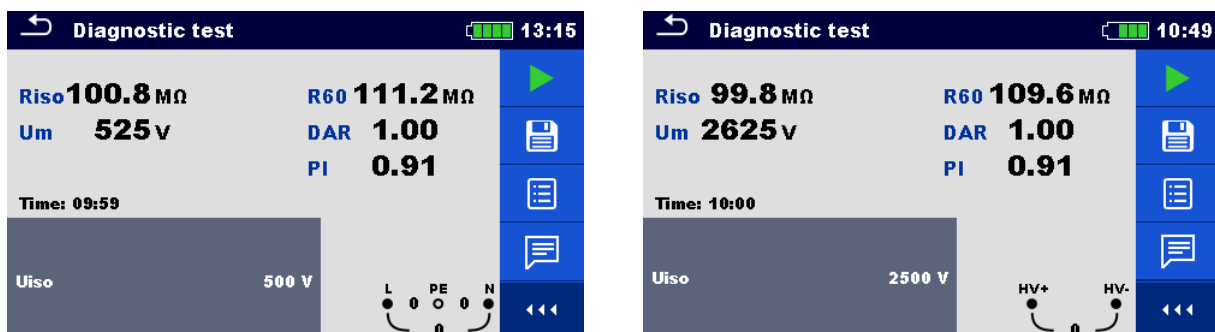

Figure 7.16: Examples of Diagnostic test result

### Measurement results / sub-results

<b>Riso</b>	Insulation resistance
<b>Um</b>	Actual test voltage
<b>R60</b>	Resistance after 60 seconds
<b>DAR</b>	Dielectric absorption ratio
<b>PI</b>	Polarization index

## 7.5 Varistor test

### Measuring principle

A voltage ramp starts from 50 V and rises with a slope of 100 V/s (Range parameter set to 1000 V) or 350 V/s (Range parameter set to 2500 V). The measurement ends when the defined end voltage is reached or if the test current exceeds the value of 1 mA.

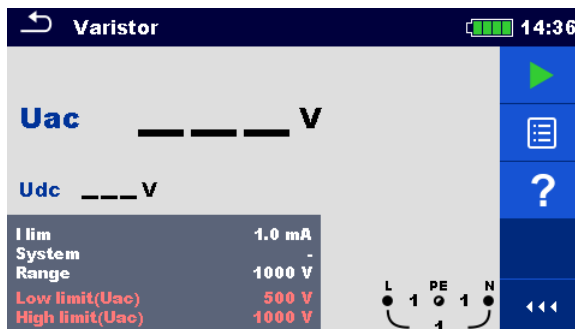

Figure 7.17: Varistor test main menu

### Measurement parameters / limits

<b>I lim</b>	<b>Current limit</b> [1.0 mA]
<b>System</b>	<b>System</b> [-, TT, TN, TN-C, TN-S]
<b>Range</b>	<b>Test voltage range</b> [1000 V, 2500 V]
<b>Low limit (Uac)</b>	<b>Low breakdown limit value</b> @ <b>1000 V</b> range [Off, 50 V ... 620 V] @ <b>2500 V</b> range [Off, 50 V ... 1550 V]
<b>High limit (Uac)</b>	<b>High breakdown limit value</b> @ <b>1000 V</b> range [Off, 50 V ... 620 V] @ <b>2500 V</b> range [Off, 50 V ... 1550 V]

### Test circuit for Varistor test

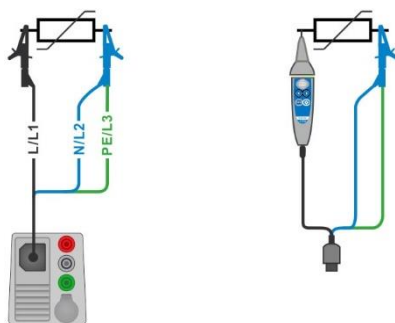

Figure 7.18: Connection of 3-wire test lead and Tip commander (Range: 1000 V)

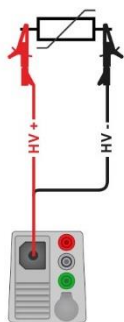

Figure 7.19: Connection of 2.5 kV test lead (Range: 2500 V)

**Measurement procedure**

- ▶ Enter the **Varistor test** function.
- ▶ Set test parameters / limits.
- ▶ Connect test cable to the instrument.
- ▶ Connect test leads to object under test (see **Figure 7.18** and **Figure 7.19**).  
Different test cable must be used if testing at Range: 1000 V or 2500 V. Also different test terminals are used.  
The standard 3-wire test lead, or Tip commander can be used for the Varistor test when testing at Range: 1000 V. If Range: 2500 V is selected, the two wire 2.5 kV test lead should be used for the Varistor test.
- ▶ Start the measurement.  
The measurement ends when the defined end voltage is reached or if the test current exceeds the value of 1 mA.
- ▶ After the measurement is finished wait until tested item is fully discharged.
- ▶ Save results (optional).

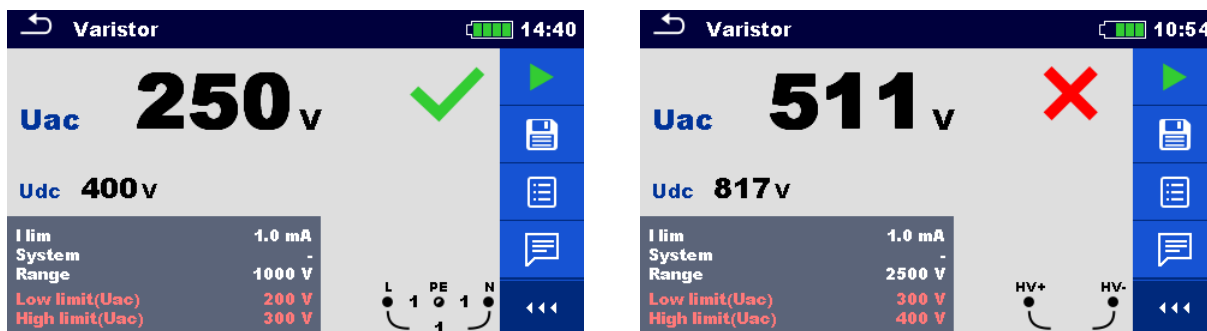

Figure 7.20: Examples of varistor test result

**Measurement results / sub-results**

- Uac** Calculated a.c. breakdown voltage
- Udc** Breakdown voltage

**Meaning of the Uac voltage**

Protection devices intended for a.c. network are usually dimensioned approx. 15 % above peak value of the nominal mains voltage. The relation between Udc and Uac is following:

$$U_{ac} \approx \frac{U_{dc}}{1.15 \times \sqrt{2}}$$

U<sub>ac</sub> voltage may be directly compared with the voltage declared on tested protection device.

## 7.6 R low – Resistance of earth connection and equipotential bonding

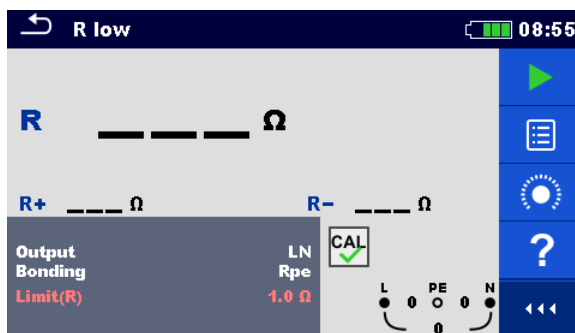

Figure 7.21: R low measurement menu

### Measurement parameters / limits

<b>Output</b> <sup>1)</sup>	[LPE, LN]
<b>Bonding</b>	[Rpe, Local]
<b>Limit(R)</b>	<b>Max. resistance</b> [Off, 0.1 Ω ... 20.0 Ω]

<sup>1)</sup> R low measurement depends on Output parameter setting, see table below.

Output	Test terminals
LN	L and N
LPE	L and PE

### Connection diagram

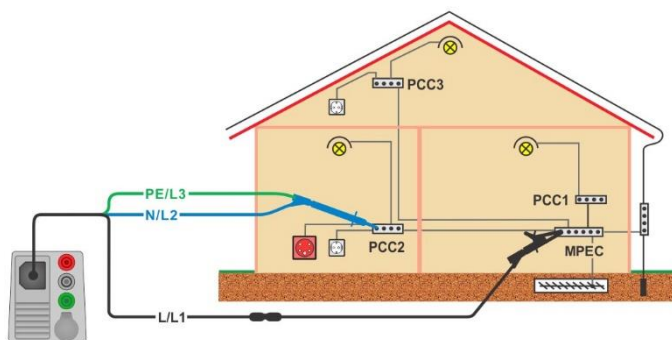

Figure 7.22: Connection of 3-wire test lead plus optional Extension lead

### Measurement procedure

- › Enter the **R low** function.
- › Set test parameters / limits.

- › Connect 3-wire test lead to the instrument.
- › Compensate the test leads resistance if necessary, see section **7.8.1 Compensation of test leads resistance**.
- › Disconnect tested installation from mains supply and discharge insulation as required.
- › Connect test leads, see **Figure 7.22**.
- › Start the measurement.
- › Save results (optional).

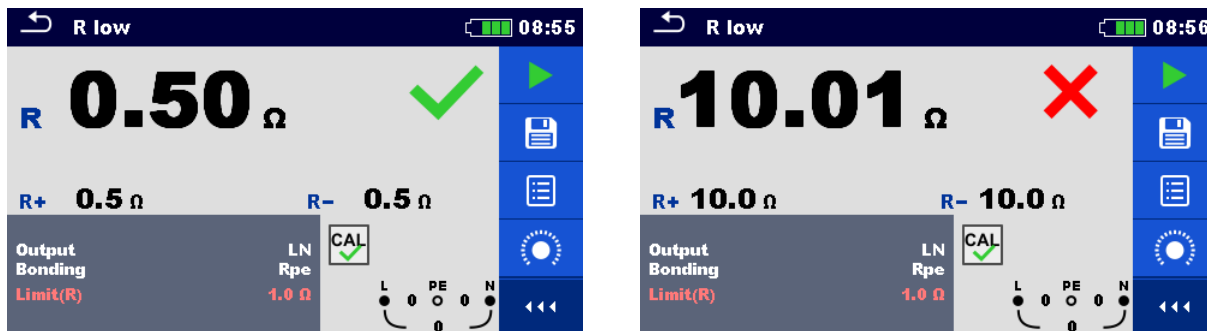

Figure 7.23: Examples of R low measurement result

Measurement results / sub-results

R	Resistance
R+	Result at positive test polarity
R-	Result at negative test polarity

## 7.7 R low 4W

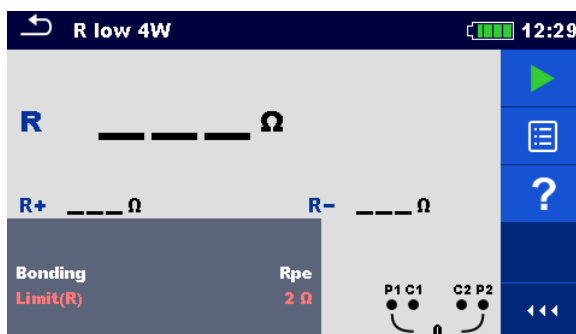

Figure 7.24: R low 4W measurement menu

Measurement parameters / limits

<b>Bonding</b>	[Rpe, Local]
<b>Limit(R)</b>	<b>Max. resistance</b> [Off, 0.1 Ω ... 20.0 Ω]



Connection diagram

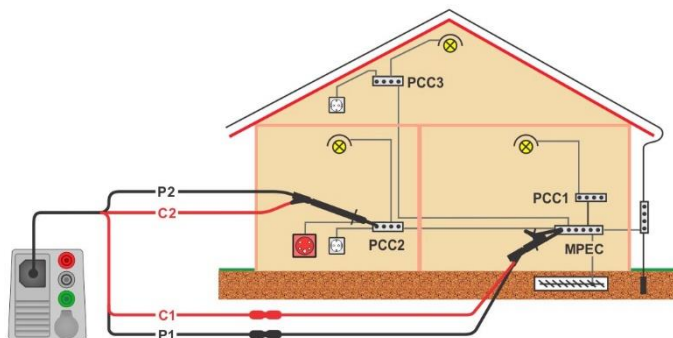

Figure 7.25: Connection of 4-wire test lead plus optional extension leads

Measurement procedure

- ▶ Enter the **R low 4W** function.
- ▶ Set test parameters / limits.
- ▶ Connect 4-wire test lead to the instrument.
- ▶ Disconnect tested installation from mains supply and discharge insulation as required.
- ▶ Connect test leads to device under test, see **Figure 7.25**. Use extension leads if necessary.
- ▶ Start the measurement.
- ▶ Save results (optional).

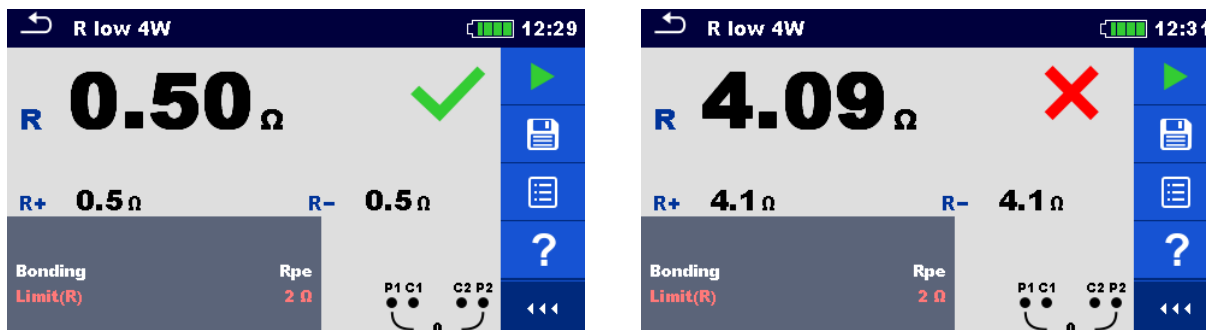

Figure 7.26: Examples of R low 4W result

Measurement results / sub-results

R	Resistance
R+	Result at positive test polarity
R-	Result at negative test polarity

## 7.8 Continuity – Continuous resistance measurement with low current

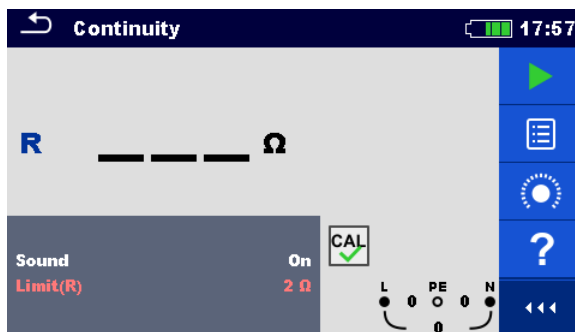

Figure 7.27: Continuity resistance measurement menu

### Measurement parameters / limits

**Sound** [On\*, Off]

**Limit(R) Max. resistance** [Off, 0.1 Ω ... 20.0 Ω]

\*Instrument sounds if resistance is lower than the set limit value.

### Connection diagrams

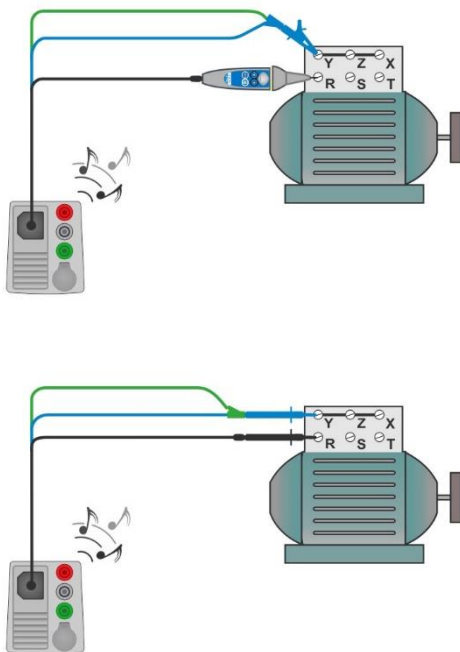

Figure 7.28: Tip commander and 3-wire test lead applications

## Measurement procedure

- › Enter the **Continuity** function.
- › Set test parameters / limits.
- › Connect test cable to the instrument.
- › Compensate the test leads resistance if necessary, see section **7.8.1 Compensation of test leads resistance**.
- › Disconnect device under test from mains supply and discharge it as required.
- › Connect test leads to device under test, see **Figure 7.28**.
- › Start the continuous measurement.
- › Stop the measurement.
- › Save results (optional).

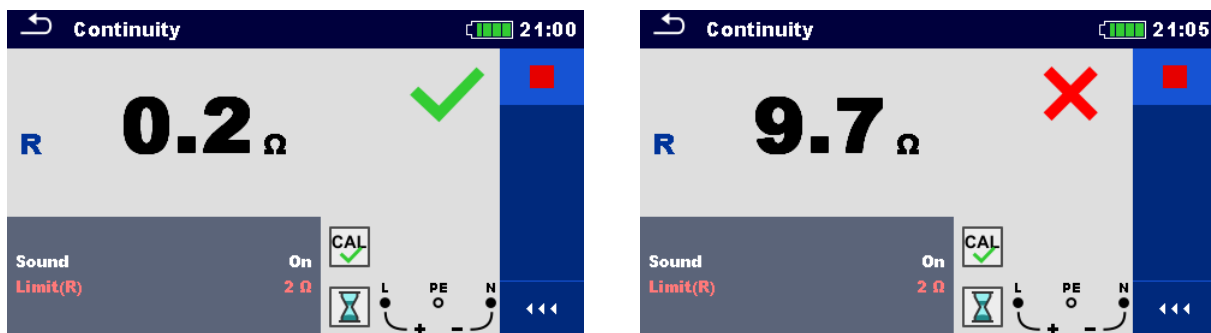

Figure 7.29: Examples of Continuity resistance measurement result

## Measurement results / sub-results

R Resistance

### 7.8.1 Compensation of test leads resistance

This chapter describes how to compensate the test leads resistance in **R low** and **Continuity** functions. Compensation is required to eliminate the influence of test leads resistance and the internal resistances of the instrument on the measured resistance. The lead compensation is therefore a very important feature to obtain correct result.

 symbol is displayed if the compensation was carried out successfully.

## Connections for compensating the resistance of test leads

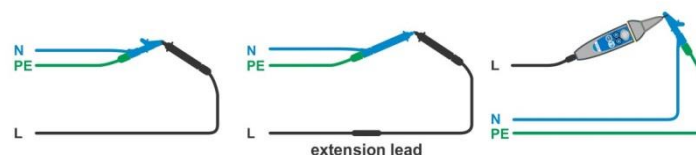



Figure 7.30: Shorted test leads

### Compensation of test leads resistance procedure

- › Enter **R low** or **Continuity** function.
- › Connect test cable to the instrument and short all test leads together, see **Figure 7.30**.
- › Touch the  key to compensate leads resistance.

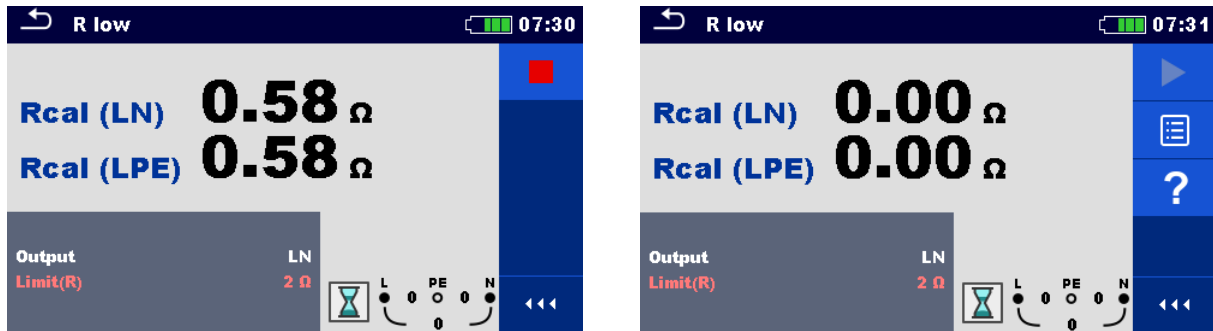

Figure 7.31: Result with old and new calibration values

## 7.9 Testing RCDs

Various test and measurements are required for verification of RCD(s) in RCD protected installations. Measurements are based on the EN 61557-6 standard.

The following measurements and tests (sub-functions) can be performed:

- Contact voltage,
- Trip-out time,
- Trip-out current and
- RCD Auto test.

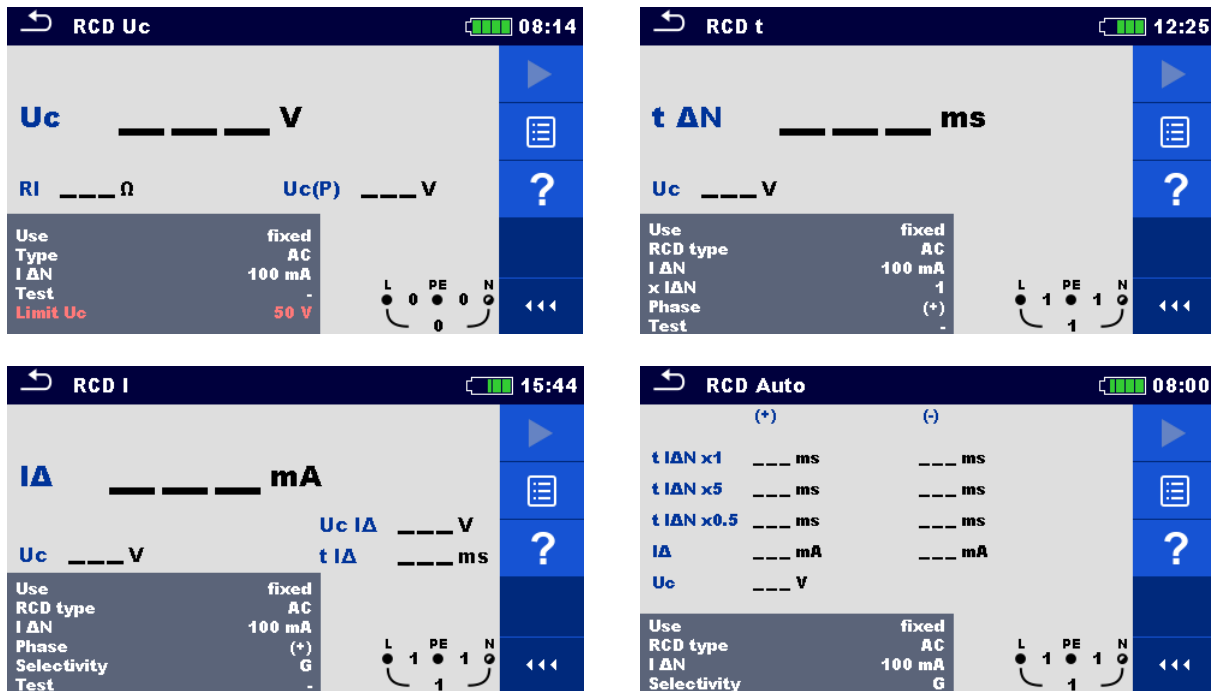

Figure 7.32: RCD menus

### Test parameters / limits

$I \Delta N$	Rated RCD residual current sensitivity [10 mA, 15 mA, 30 mA, 100 mA, 300 mA, 500 mA, 1000 mA]
$I \Delta N / I \Delta N_{dc}$	Rated RCD residual current sensitivity for special RCDs types [30 mA / 6 mA d.c.] <sup>1)</sup>
RCD type	RCD type [AC, A, F, B, B+, EV RCD <sup>1)</sup> , MI RCD <sup>1)</sup> ]
Use	RCD / PRCD selection [fixed, PRCD, PRCD-S, PRCD-K, other]
Selectivity	Characteristic [G, S]
$x I \Delta N$	Multiplication factor for test current [0.5, 1, 2, 5]
Phase	Starting polarity [(+), (-), (+,-)]
Test	Test [-, L/PE, L1/PE, L2/PE, L3/PE]
Test	Test current shape [a.c., d.c.] <sup>2)</sup>
Uc (P)	Contact voltage, external probe [On, Off]
Limit Uc	Conventional touch voltage limit [12 V, 25 V, 50 V]
RCD Standard	Refer to chapter <b>4.6.8.1 RCD standard</b> for more information.
Earthing system	Refer to chapter <b>4.6.8 Settings</b> for more information.

<sup>1)</sup> Parameter is available only when parameter Use is set to other (for Electrical Vehicle (EV) RCDs and Mobile installations (MI) RCDs).

- 2) Parameter is available only when RCD I test is selected and parameter Use is set to 'other'.

### Connection diagrams

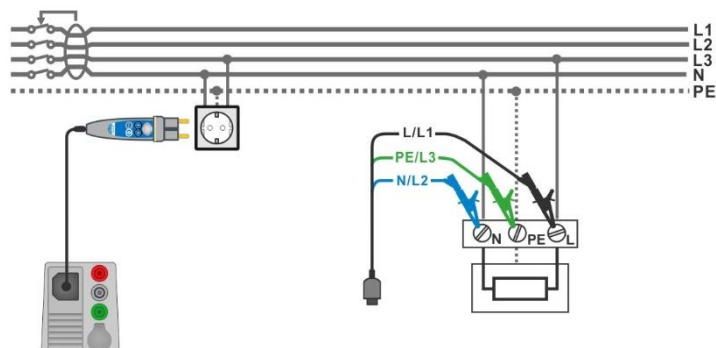

Figure 7.33: Connecting the Plug commander and the 3-wire test lead

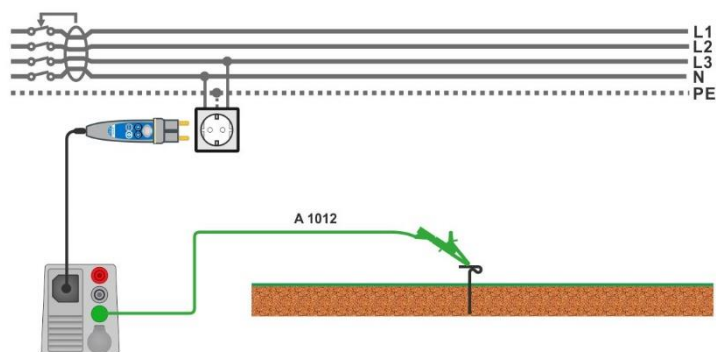

Figure 7.34: Connection for  $U_c(P)$  measurement

## 7.9.1 RCD $U_c$ – Contact voltage

Measuring current up to  $\frac{1}{3}$  of nominal residual current is used for measurement of contact voltage.

Contact voltage measurement is performed before trip-out time/current tests. If limit voltage (e.g. 50 V) is reached during this pre-test, trip-out test is aborted for safety reason.

### 7.9.1.1 RCD $U_c(P)$ – Contact voltage with external probe

Contact voltage measurement can also be performed using external test probe. Place external probe to reference earth potential.

For connection see **Figure 7.34 Connection for  $U_c(P)$  measurement.**

Before the contact voltage measurement make sure that  $U_c(P)$  parameter is set to On.

**Test procedure**

- › Enter the **RCD Uc** function.
- › Set test parameters / limits.
- › Connect test cables to the instrument.
- › Connect L, N and PE of 3-wire test lead or Plug commander to the object under test, see **Figure 7.33**.
- › Connect test lead to P/S terminal and external earthed point (optional, see **Figure 7.34**).
- › Start the measurement.
- › Save results (optional).

The contact voltage results  $U_c$  and  $U_c(P)$  relate to the rated nominal residual current of the RCD and are multiplied by an appropriate factor (depending on RCD type and type of test current). The 1.05 factor is applied to avoid negative tolerance of result. See **Table 7.2** for detailed contact voltage calculation factors.

RCD type		Contact voltages $U_c$ and $U_c(P)$ proportional to	Rated $I_{\Delta N}$
AC, EV, MI (a.c. part)	G	$1.05 \times I_{\Delta N}$	any
AC	S	$2 \times 1.05 \times I_{\Delta N}$	
A, F	G	$1.4 \times 1.05 \times I_{\Delta N}$	$\geq 30$ mA
A, F	S	$2 \times 1.4 \times 1.05 \times I_{\Delta N}$	
A, F	G	$2 \times 1.05 \times I_{\Delta N}$	$< 30$ mA
A, F	S	$2 \times 2 \times 1.05 \times I_{\Delta N}$	
B, B+	G	$2 \times 1.05 \times I_{\Delta N}$	any
B, B+	S	$2 \times 2 \times 1.05 \times I_{\Delta N}$	

**Table 7.2: Relationship between  $U_c$ ,  $U_c(P)$  and  $I_{\Delta N}$**

Fault Loop resistance is indicative and calculated from  $U_c$  result (without additional proportional factors) according to:  $R_L = \frac{U_c}{I_{\Delta N}}$ .

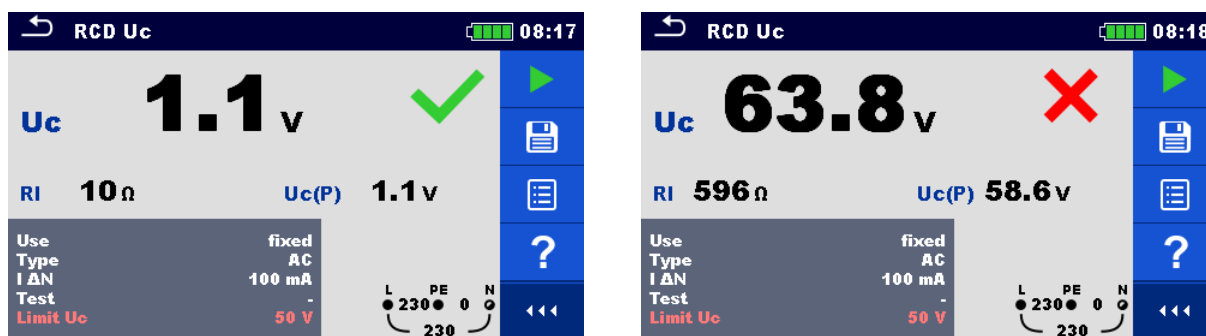

**Figure 7.35: Examples of Contact voltage measurement result**

**Test result / sub-results**

<b><math>U_c</math></b>	Contact voltage
<b><math>U_c(P)</math> – if selected</b>	Contact voltage, external probe
<b>RI</b>	Fault loop resistance

### 7.9.2 RCD t – Trip-out time

#### Test procedure

- › Enter the **RCD t** function.
- › Set test parameters / limits.
- › Connect test cable to the instrument.
- › Connect 3-wire test lead or Plug commander to the object under test, see **Figure 7.33**.
- › Start the measurement.
- › Save results (optional).

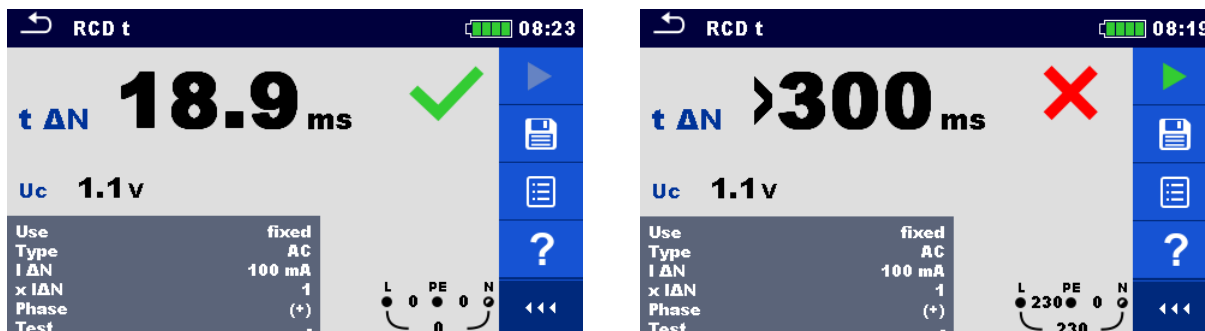

Figure 7.36: Examples of Trip-out time measurement result

#### Test results / sub-results

<b>t ΔN</b>	Trip-out time
<b>Uc</b>	Contact voltage for rated I <sub>ΔN</sub>

### 7.9.3 RCD I – Trip-out current

The instrument increases the test current in small steps through appropriate range as follows:

RCD type	Slope range		Waveform
	Start value	End value	
AC, EV, MI (a.c. part)	0.2×I <sub>ΔN</sub>	1.1×I <sub>ΔN</sub>	Sine
A, F (I <sub>ΔN</sub> ≥ 30 mA)	0.2×I <sub>ΔN</sub>	1.5×I <sub>ΔN</sub>	Pulsed
A, F (I <sub>ΔN</sub> = 10 mA)	0.2×I <sub>ΔN</sub>	2.2×I <sub>ΔN</sub>	
B, B+, EV, MI (d.c. part)	0.2×I <sub>ΔN</sub>	2.2×I <sub>ΔN</sub>	DC

Table 7.3: Relationship between RCD type, slope range and test current

Maximum test current is I<sub>Δ</sub> (trip-out current) or end value in case the RCD didn't trip-out.

#### Test procedure

- › Enter the **RCD I** function.
- › Set test parameters / limits.
- › Connect test cable to the instrument.
- › Connect 3-wire test lead or Plug commander to the object under test, see **Figure 7.33**.
- › Start the measurement.
- › Save results (optional).



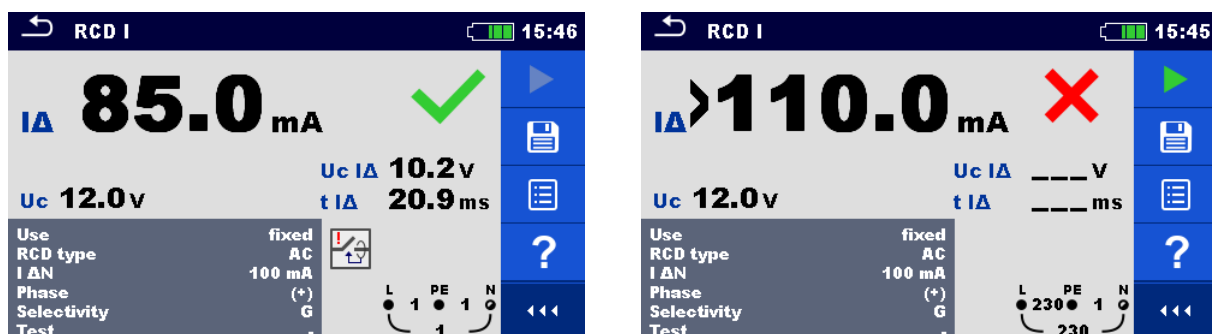

Figure 7.37: Examples of Trip-out current measurement result

## Test results / sub-results

<b>I<math>\Delta</math></b>	Trip-out current
<b>U<sub>c</sub></b>	Contact voltage
<b>U<sub>c</sub> I<math>\Delta</math></b>	Contact voltage at trip-out current I $\Delta$ or no value if the RCD didn't trip
<b>t I<math>\Delta</math></b>	Trip-out time at trip-out current I $\Delta$

## 7.10 RCD Auto – RCD Auto test

RCD Auto test function performs a complete RCD test (trip-out time at different residual currents, trip-out current and contact voltage) in one set of automatic tests, guided by the instrument.

### RCD Auto test procedure

RCD Auto test steps	Notes
<ul style="list-style-type: none"> <li>Enter the <b>RCD Auto</b> function.</li> <li>Set test parameters / limits.</li> <li>Connect test cable to the instrument.</li> <li>Connect 3-wire test lead or Plug commander to the object under test, see <b>Figure 7.33</b></li> <li>Start the measurement.</li> </ul>	Start of test
Test with $I_{\Delta N}$ , (+) positive polarity (step 1).	RCD should trip-out
<ul style="list-style-type: none"> <li><b>Re-activate RCD.</b></li> </ul>	
Test with $I_{\Delta N}$ , (-) negative polarity (step 2).	RCD should trip-out
<ul style="list-style-type: none"> <li><b>Re-activate RCD.</b></li> </ul>	
Test with $5 \times I_{\Delta N}$ , (+) positive polarity (step 3).	RCD should trip-out
<ul style="list-style-type: none"> <li><b>Re-activate RCD.</b></li> </ul>	
Test with $5 \times I_{\Delta N}$ , (-) negative polarity (step 4).	RCD should trip-out
<ul style="list-style-type: none"> <li><b>Re-activate RCD.</b></li> </ul>	
Test with $\frac{1}{2} \times I_{\Delta N}$ , (+) positive polarity (step 5).	RCD should not trip-out
Test with $\frac{1}{2} \times I_{\Delta N}$ , (-) negative polarity (step 6).	RCD should not trip-out
Trip-out current test, (+) positive polarity (step 7).	RCD should trip-out
<ul style="list-style-type: none"> <li><b>Re-activate RCD.</b></li> </ul>	
Trip-out current test, (-) negative polarity (step 8).	RCD should trip-out
<ul style="list-style-type: none"> <li><b>Re-activate RCD<sup>1)</sup>.</b></li> </ul>	
Trip-out current test for d.c. part, (+) polarity (step 9).	RCD should trip-out
<ul style="list-style-type: none"> <li><b>Re-activate RCD<sup>1)</sup>.</b></li> </ul>	
Trip-out current test for d.c. part, (-) polarity (step 10).	RCD should trip-out
<ul style="list-style-type: none"> <li><b>Re-activate RCD.</b></li> </ul>	
Save results (optional).	End of test

<sup>1)</sup> Steps 9 and 10 are performed if parameter Use is set to 'other' and Type to EV or MI RCD.

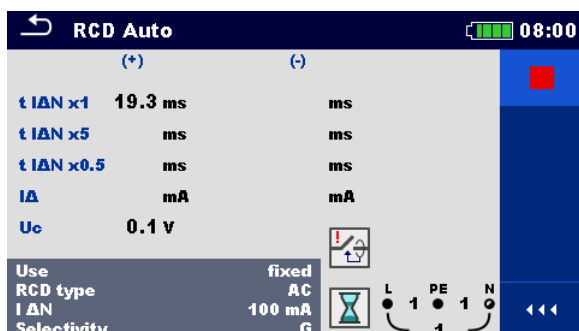

Step 1

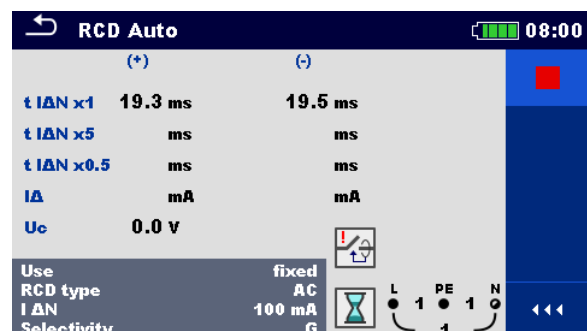

Step 2

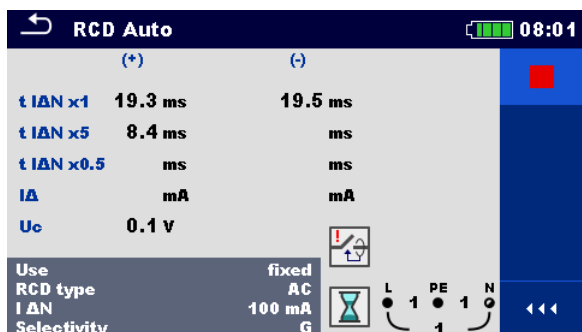

Step 3

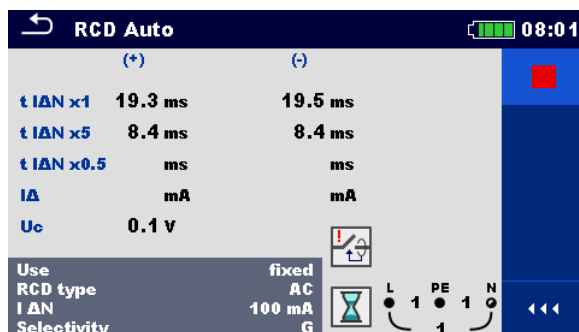

Step 4

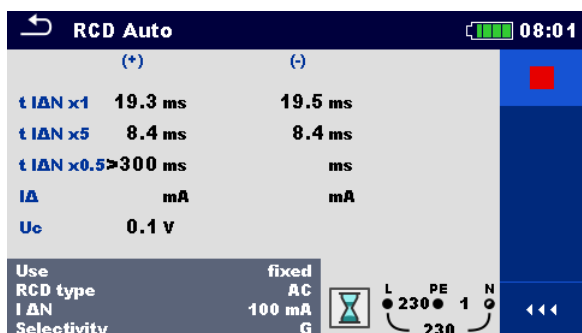

Step 5

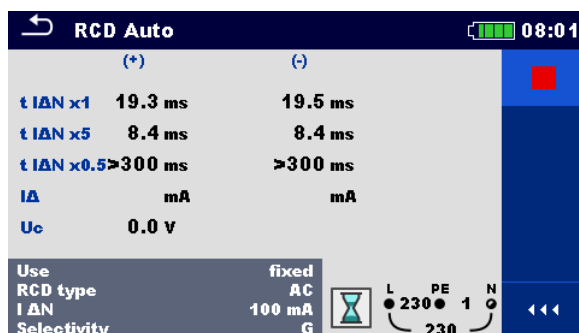

Step 6

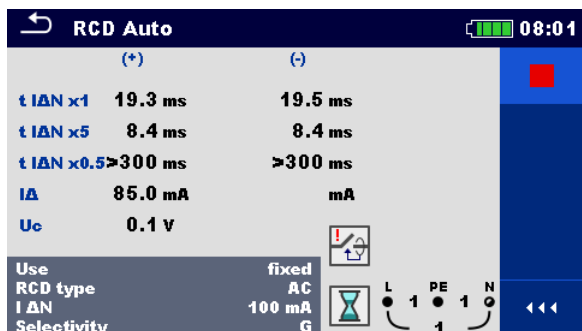

Step 7

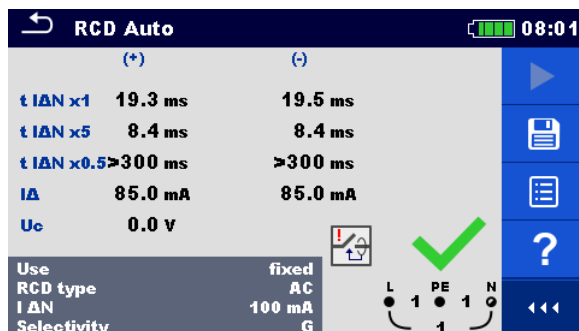

Step 8

Figure 7.38: Individual steps in RCD Auto test

## Test results / sub-results

<b>t I<math>\Delta</math>N x1, (+)</b>	Step 1 trip-out time ( $I_{\Delta}=I_{\Delta N}$ , (+) positive polarity)
<b>t I<math>\Delta</math>N x1, (-)</b>	Step 2 trip-out time ( $I_{\Delta}=I_{\Delta N}$ , (-) negative polarity)
<b>t I<math>\Delta</math>N x5, (+)</b>	Step 3 trip-out time ( $I_{\Delta}=5\times I_{\Delta N}$ , (+) positive polarity)
<b>t I<math>\Delta</math>N x5, (-)</b>	Step 4 trip-out time ( $I_{\Delta}=5\times I_{\Delta N}$ , (-) negative polarity)
<b>t I<math>\Delta</math>N x0.5, (+)</b>	Step 5 trip-out time ( $I_{\Delta}=\frac{1}{2}\times I_{\Delta N}$ , (+) positive polarity)
<b>t I<math>\Delta</math>N x0.5, (-)</b>	Step 6 trip-out time ( $I_{\Delta}=\frac{1}{2}\times I_{\Delta N}$ , (-) negative polarity)
<b>I<math>\Delta</math> (+)</b>	Step 7 trip-out current ((+) positive polarity)
<b>I<math>\Delta</math> (-)</b>	Step 8 trip-out current ((-) negative polarity)
<b>I<math>\Delta</math> d.c. (+)<sup>1)</sup></b>	Step 9 trip-out current ((+) positive polarity)
<b>I<math>\Delta</math> d,c, (-)<sup>1)</sup></b>	Step 10 trip-out current ((-) negative polarity)
<b>Uc</b>	Contact voltage for rated $I_{\Delta N}$

<sup>1)</sup> Result is displayed when parameter Use is set to 'other' and Type to EV RCD or MI RCD.

## 7.11 Z loop – Fault loop impedance and prospective fault current

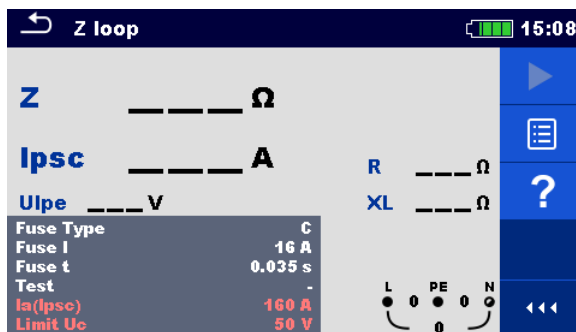

Figure 7.39: Z loop menu

### Measurement parameters / limits

<b>Fuse Type</b>	<b>Selection of fuse type</b> [Off, gG, NV, B, C, D, K, Custom]
<b>Fuse I</b>	<b>Rated current of selected fuse</b>
<b>Fuse t</b>	<b>Maximum breaking time of selected fuse</b>
<b>Isc factor</b>	<b>Isc factor</b> [0.20 ... 3.00]
<b>Test<sup>1)</sup></b>	<b>Selection of test</b> [-, L/PE, L1/PE, L2/PE, L3/PE]
<b>Uc (P)</b>	<b>Contact voltage measurement with external probe</b> [Off, On]
<b>Earthing system</b>	Refer to chapter <b>4.6.8 Settings</b> for more information.
<b>Ia(Ipsc)</b>	<b>Minimum fault current for selected fuse or custom value</b>
<b>Limit Uc</b>	<b>Contact voltage limit</b> [12 V, 25 V, 50 V]

<sup>1)</sup> With Plug test cable or Plug commander Z loop is measured in the same way regardless of the setting. The parameter is meant for documentation.

Refer to **Fuse tables guide** for detailed information on fuse data.

### Connection diagrams

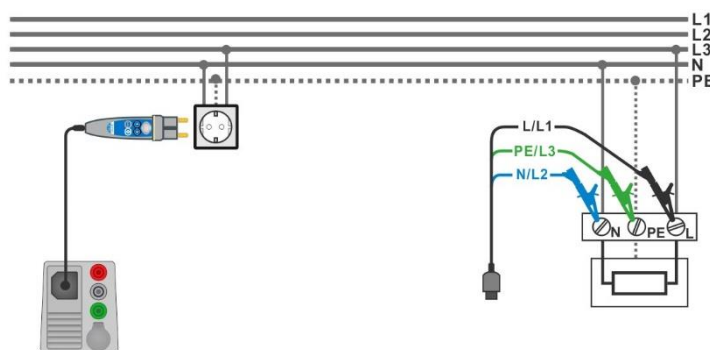

Figure 7.40: Connection of Plug commander and 3-wire test lead

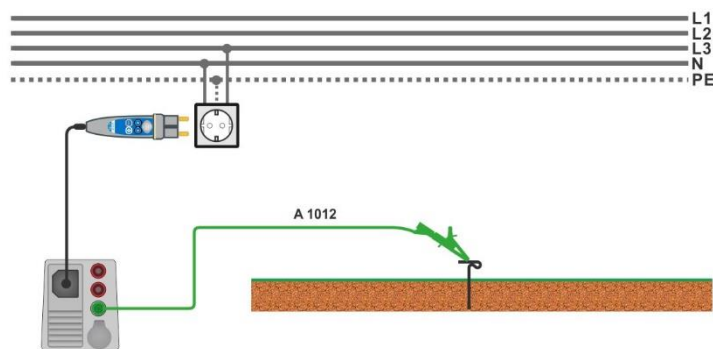

Figure 7.41: Connection for Uc(P) measurement

Measurement procedure

- › Enter the **Z loop** function.
- › Set test parameters / limits.
- › Connect test cable to the instrument.
- › Connect 3-wire test lead or Plug commander to the object under test, see **Figure 7.40**.
- › Connect test lead P/S to external earthed point (optional), see **Figure 7.41**.
- › Start the measurement.
- › Save results (optional).

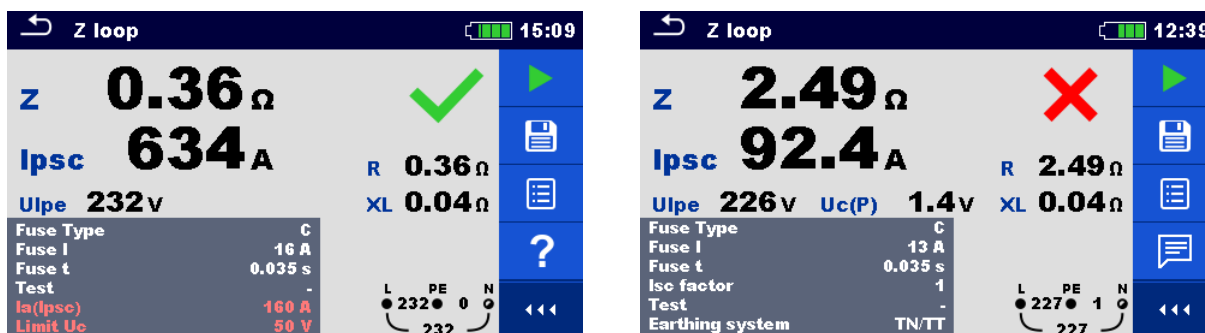

Figure 7.42: Examples of Loop impedance measurement result

Measurement results / sub-results

<b>Z</b>	Loop impedance
<b>IpSC</b>	Prospective fault current
<b>Ulpe</b>	Voltage L-PE
<b>R</b>	Resistance of loop impedance
<b>XL</b>	Reactance of loop impedance
<b>Uc (P)</b>	Contact voltage at prospective fault current (external probe)

Prospective fault current  $I_{PSC}$  is calculated from measured impedance as follows:

$$I_{PSC} = \frac{U_N \times k_{SC}}{Z}$$

where:

$U_N$ ..... Nominal  $U_{L-PE}$  voltage (see table below),

$k_{SC}$  ..... Correction factor (Isc factor) for  $I_{PSC}$ . Refer to chapter **4.6.8 Settings** for more information.

$U_C(P)$  .... Voltage between external earthed point and main earthing point (P/S and PE terminals), see calculation below

$U_n$	Input voltage range (L-PE)
110 V	$(93 \text{ V} \leq U_{L-PE} \leq 134 \text{ V})$
230 V	$(185 \text{ V} \leq U_{L-PE} \leq 266 \text{ V})$

**Table 7.4: Relationship between Input voltage –  $U_{L-PE}$  and nominal voltage –  $U_n$  used for calculation**

$U_C(P)$  calculation

$$U_C(P) = Z_{PE-P/S} \times I_{PSC},$$

## 7.12 Z loop 4W – Fault loop impedance and prospective fault current

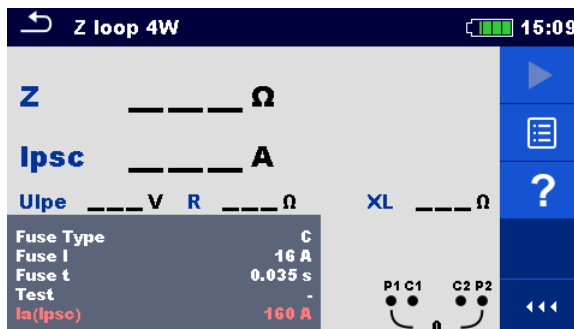

Figure 7.43: Z loop 4W menu

### Measurement parameters / limits

<b>Fuse Type</b>	Selection of fuse type [Off, gG, NV, B, C, D, K, Custom]
<b>Fuse I</b>	Rated current of selected fuse
<b>Fuse t</b>	Maximum breaking time of selected fuse
<b>Isc factor</b>	Isc factor [0.20 ... 3.00]
<b>Test</b>	Selection of test [-, L-PE, L1-PE, L2-PE, L3-PE]
<b>Ia (Ipsc)</b>	Minimum short circuit current for selected fuse or custom value

Refer to *Fuse tables guide* for detailed information on fuse data.

### Connection diagram

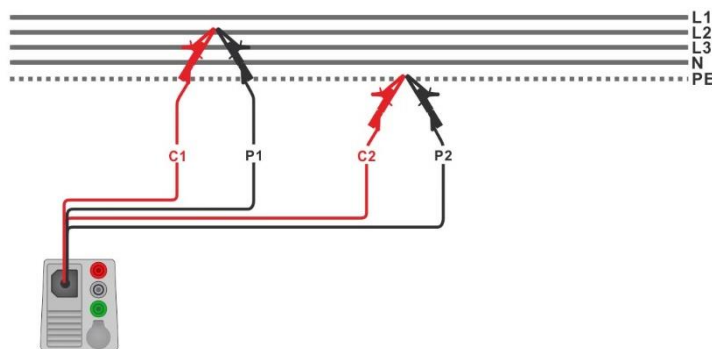

Figure 7.44: Connection of 4-wire test lead

### Measurement procedure

- › Enter the **Z loop 4W** function.
- › Set test parameters / limits.
- › Connect test cable to the instrument.
- › Connect 4-wire test lead to the object under test, C1, P1 terminals to phase and C2, P2 terminals to PE; see **Figure 7.44**.
- › Start the measurement.
- › Save results (optional).



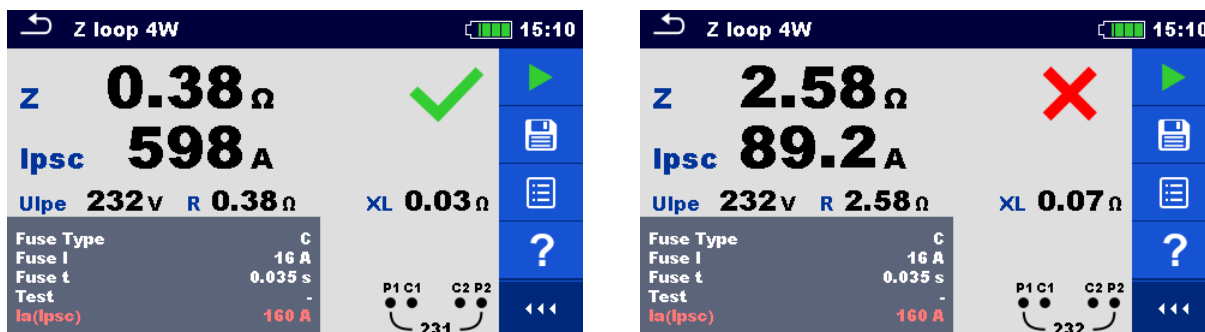

Figure 7.45: Example of Z loop 4W measurement result

Measurement results / sub-results

Z	Loop impedance
Ipsc	Prospective fault current
Ulpe	Voltage L-PE
R	Resistance of loop impedance
XL	Reactance of loop impedance

Prospective fault current  $I_{PSC}$  is calculated from measured impedance as follows:

$$I_{PSC} = \frac{U_n \times k_{SC}}{Z}$$

where:

$U_n$ ..... Nominal  $U_{L-PE}$  voltage (see table below),  
 $k_{sc}$ ..... Correction factor (Isc factor) for  $I_{PSC}$ . Refer to chapter **4.6.8 Settings** for more information.

$U_n$	Input voltage range (L-PE)
110 V	(93 V ≤ $U_{L-PE}$ ≤ 134 V)
230 V	(185 V ≤ $U_{L-PE}$ ≤ 266 V)

Table 7.5: Relationship between Input voltage –  $U_{L-PE}$  and nominal voltage –  $U_n$  used for calculation

## 7.13 Zs rcd – Fault loop impedance and prospective fault current in system with RCD

Zs rcd measurement prevents trip-out of the RCD in systems with the RCD.

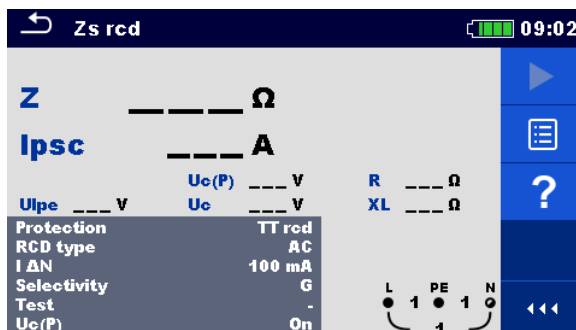

Figure 7.46: Zs rcd menu

### Measurement parameters / limits

<b>Protection</b>	<b>Protection type</b> [TN, TT rcd]
<b>Fuse Type<sup>1)</sup></b>	<b>Selection of fuse type</b> [Off, gG, NV, B, C, D, K, Custom]
<b>Fuse I<sup>1)</sup></b>	<b>Rated current of selected fuse</b>
<b>Fuse t<sup>1)</sup></b>	<b>Maximum breaking time of selected fuse</b>
<b>Ia(Ipsc)<sup>1)</sup></b>	<b>Minimum fault current for selected fuse or custom value</b>
<b>Isc factor</b>	<b>Isc factor</b> [0.20 ... 3.00]
<b>Test<sup>3)</sup></b>	<b>Selection of test</b> [-, L-PE, L1-PE, L2-PE, L3-PE]
<b>I ΔN<sup>2)</sup></b>	<b>Rated RCD residual current sensitivity</b> [10 mA, 15 mA, 30 mA, 100 mA, 300 mA, 500 mA, 1000 mA]
<b>RCD type<sup>2)</sup></b>	<b>RCD type</b> [AC, A, F, B, B+]
<b>Selectivity<sup>2)</sup></b>	<b>Characteristic</b> [G, S]
<b>Uc (P)</b>	<b>Contact voltage measurement with external probe</b> [On, Off]
<b>I test</b>	<b>Test current</b> [Standard, Low]
<b>Limit Uc<sup>2)</sup></b>	<b>Contact voltage limit</b> [12 V, 25 V, 50 V]

<sup>1)</sup> Parameter or limit is considered if Protection is set to TN.

<sup>2)</sup> Parameter or limit is considered if Protection is set to TT rcd.

<sup>3)</sup> With Plug test cable or Plug commander Zs rcd is measured in the same way regardless of the setting. The parameter is meant for documentation.

Refer to **Fuse tables guide** for detailed information on fuse data.

Connection diagrams

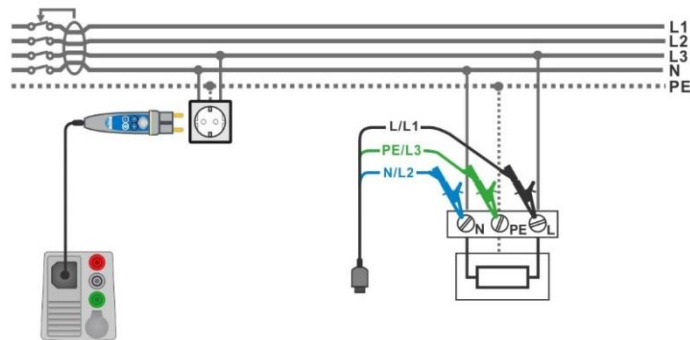

Figure 7.47: Connection of Plug commander and 3-wire test lead

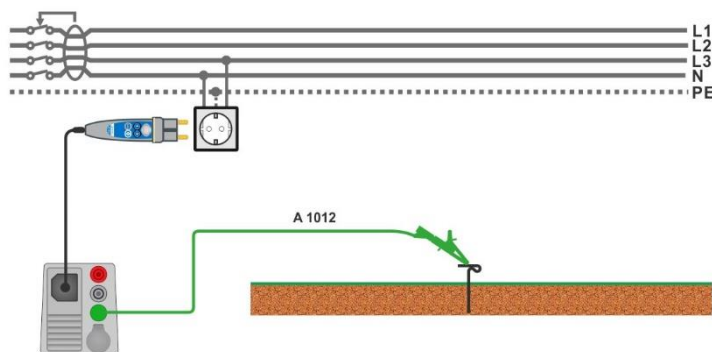

Figure 7.48: Connection for  $U_c(P)$  measurement

Measurement procedure

- ▶ Enter the **Zs rcd** function.
- ▶ Set test parameters / limits.
- ▶ Connect test cable to the instrument.
- ▶ Connect 3-wire test lead or Plug commander to the object under test, see **Figure 7.47**.
- ▶ Connect test lead P/S to external earthed point (optional), see **Figure 7.48**.
- ▶ Start the measurement.
- ▶ Save results (optional).

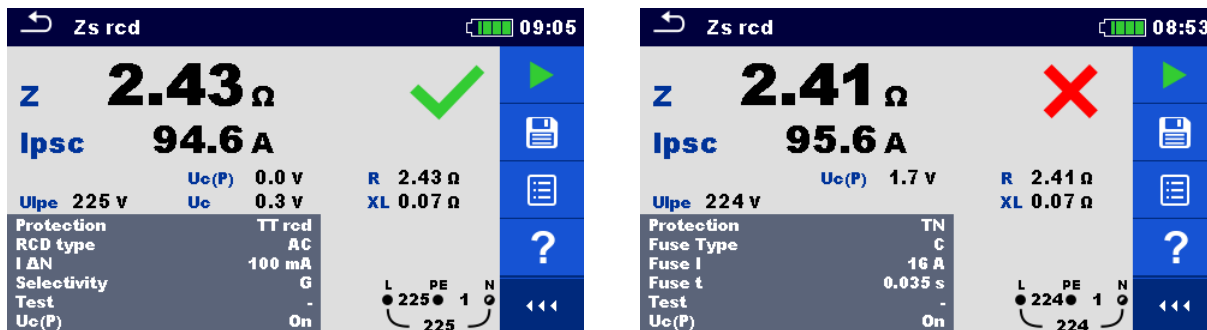

Figure 7.49: Examples of  $Z_s$  rcd measurement result

**Measurement results / sub-results**

<b>Z</b>	Loop impedance
<b>Ipsc</b>	Prospective fault current
<b>Ulpe</b>	Voltage L-PE
<b>Uc</b> <sup>1)</sup>	Contact voltage at nominal residual current
<b>Uc (P)</b>	Contact voltage at prospective fault current (external probe) <sup>2)</sup> Contact voltage at nominal residual current (external probe) <sup>3)</sup>
<b>R</b>	Resistance of loop impedance
<b>XL</b>	Reactance of loop impedance

<sup>1)</sup> Result is presented only if Protection is set to TTrcd.  
<sup>2)</sup> Protection type parameter set to TN.  
<sup>3)</sup> Protection type parameter set to TTrcd.

Prospective fault current  $I_{PSC}$  is calculated from measured impedance as follows:

$$I_{PSC} = \frac{U_N \times k_{SC}}{Z}$$

where:

$U_n$ ..... Nominal  $U_{L-PE}$  voltage (see table below),

$k_{SC}$  ..... Correction factor (Isc factor) for  $I_{PSC}$ . Refer to chapter **4.6.8 Settings** for more information.

$U_c(P)$  .... Voltage between external earthed point and main earthing point (P and PE terminals), see calculation below

<b><math>U_n</math></b>	<b>Input voltage range (L-PE)</b>
110 V	$(93 \text{ V} \leq U_{L-PE} \leq 134 \text{ V})$
230 V	$(185 \text{ V} \leq U_{L-PE} \leq 266 \text{ V})$

**Table 7.6: Relationship between Input voltage –  $U_{L-PE}$  and nominal voltage –  $U_n$  used for calculation**

$U_c(P)$  calculation

$$U_c(P) = \begin{cases} Z_{PE-P/S} \times I_{\Delta N}, & \text{Protection} = \text{TTrcd} \\ Z_{PE-P/S} \times I_{PFC}, & \text{Protection} = \text{TN} \end{cases}$$

## 7.14 Z loop mΩ – High precision fault loop impedance and prospective fault current

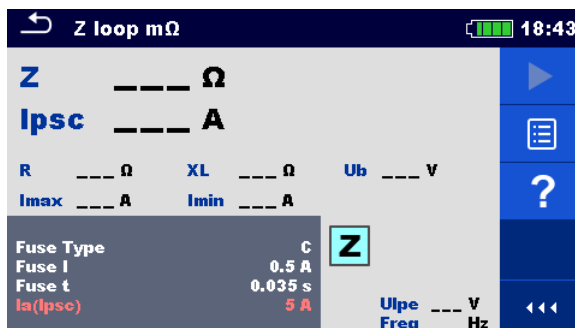

Figure 7.50: Z loop mΩ menu

### Measurement parameters / limits

<b>Fuse Type</b>	Selection of fuse type [Off, gG, NV, B, C, D, K, Custom]
<b>Fuse I</b>	Rated current of selected fuse
<b>Fuse t</b>	Maximum breaking time of selected fuse
<b>Test<sup>1)</sup></b>	Test [-, L/PE, L1/PE, L2/PE, L3/PE]
<b>Ia(Ipsc)</b>	Minimum fault current for selected fuse or custom value

<sup>1)</sup> The measurement doesn't depend on the setting. The parameter is meant for documentation.

Refer to **Fuse tables guide** for detailed information on fuse data.

### Connection diagram

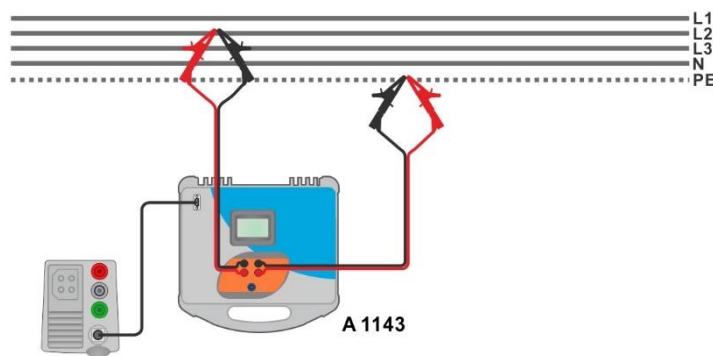

Figure 7.51: High precision loop impedance measurement – Connection of A 1143

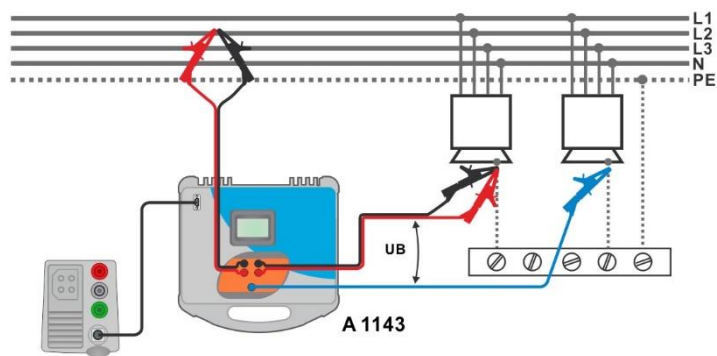



Figure 7.52: Contact voltage measurement – Connection of A 1143

Measurement procedure

- ▶ Enter the **Z loop mΩ** function.
- ▶ Set test parameters / limits.
- ▶ Connect test leads to A 1143 – Euro Z 290 A adapter and switch it on.
- ▶ Connect A 1143 – Euro Z 290 A adapter to the instrument using RS232-PS/2 cable.
- ▶ Connect test leads to the object under test, see **Figure 7.51** and **Figure 7.52**.
- ▶ Start the measurement using  or  button.
- ▶ Save results (optional).

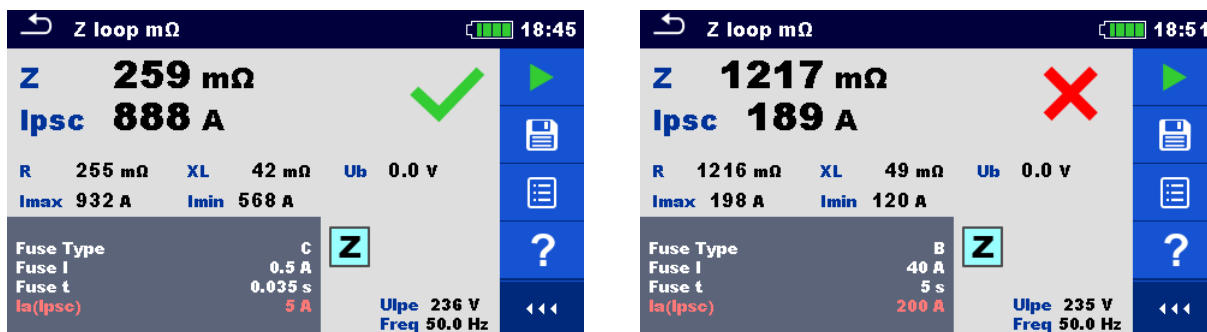

Figure 7.53: Examples of high precision Loop impedance measurement result

Measurement results / sub-results

<b>Z</b>	Loop impedance
<b>Ipsc</b>	Standard prospective fault current
<b>I<sub>max</sub></b>	Maximal prospective fault current
<b>I<sub>min</sub></b>	Minimal prospective fault current
<b>U<sub>b</sub></b>	Contact voltage at maximal prospective fault current (contact voltage measured against Probe S if used)
<b>R</b>	Resistance of loop impedance
<b>XL</b>	Reactance of loop impedance
<b>U<sub>lpe</sub></b>	Voltage L-PE
<b>Freq</b>	Frequency

Standard prospective fault current  $I_{PSC}$  is calculated as follows:

$$I_{PSC} = \frac{230 V}{Z} \quad \text{where} \quad U_{L-PE} = 230 V \pm 10 \%$$

The prospective fault currents  $I_{Min}$  and  $I_{Max}$  are calculated as follows:

$$I_{Min} = \frac{C_{min} U_{N(L-PE)}}{Z_{(L-PE)hot}} \quad \text{where} \quad Z_{(L-PE)hot} = \sqrt{(1.5R_{L-PE})^2 + X_{L-PE}^2}$$

$$C_{min} = \begin{cases} 0.95; & U_{N(L-PE)} = 230 V \pm 10 \% \\ 1.00; & \text{otherwise} \end{cases}$$

and

$$I_{Max} = \frac{C_{max} U_{N(L-PE)}}{Z_{L-PE}} \quad \text{where} \quad Z_{L-PE} = \sqrt{R_{L-PE}^2 + X_{L-PE}^2}$$

$$C_{max} = \begin{cases} 1.05; & U_{N(L-PE)} = 230 V \pm 10 \% \\ 1.10; & \text{otherwise} \end{cases}$$

Refer to **A 1143 – Euro Z 290 A adapter Instruction manual** for detailed information.

## 7.15 Z line – Line impedance and prospective short-circuit current

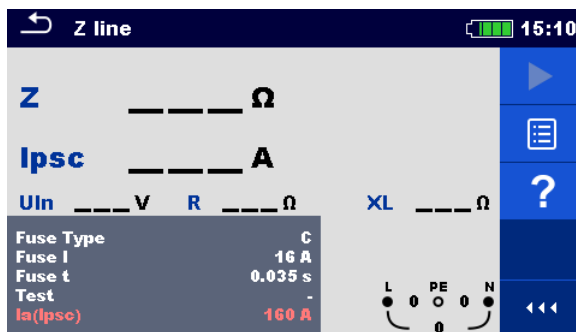

Figure 7.54: Z line measurement menu

### Measurement parameters / limits

<b>Fuse Type</b>	<b>Selection of fuse type</b> [Off, gG, NV, B, C, D, K, Custom]
<b>Fuse I</b>	<b>Rated current of selected fuse</b>
<b>Fuse t</b>	<b>Maximum breaking time of selected fuse</b>
<b>Isc factor</b>	<b>Isc factor</b> [0.20 ... 3.00]
<b>Test<sup>1)</sup></b>	<b>Test</b> [-, L/N, L/L, L1/N, L2/N, L3/N, L1/L2, L1/L3, L2/L3]
<b>Earthing system</b>	Refer to chapter <b>4.6.8 Settings</b> for more information.
<b>Ia(Ipsc)</b>	<b>Minimum short-circuit current for selected fuse or custom value</b>

<sup>1)</sup> With Plug test cable or Plug commander Z line is measured in the same way regardless of the setting. The parameter is meant for documentation.

Refer to **Fuse tables guide** for detailed information on fuse data.

### Connection diagram

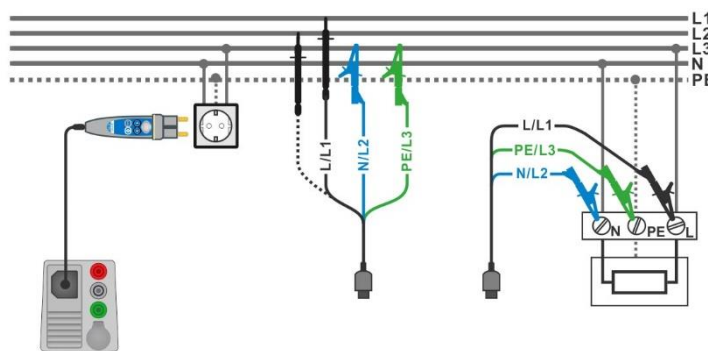

Figure 7.55: Phase-neutral or phase-phase line impedance measurement – connection of Plug commander and 3-wire test lead



## Measurement procedure

- › Enter the **Z line** function.
- › Set test parameters / limits.
- › Connect test cable to the instrument.
- › Connect 3-wire test lead or Plug commander to the object under test, see **Figure 7.55**.
- › Start the measurement.
- › Save results (optional).

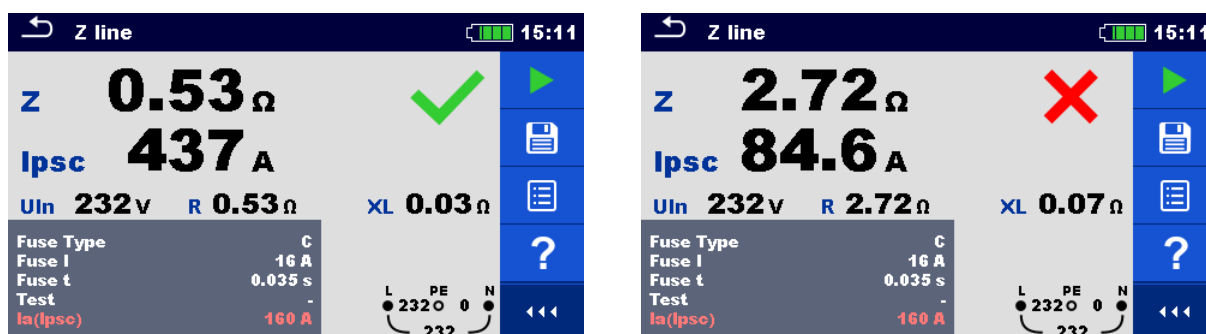

Figure 7.56: Examples of Line impedance measurement result

## Measurement results / sub-results

<b>Z</b>	Line impedance
<b>Ipsc</b>	Prospective short-circuit current
<b>Uln</b>	Voltage measured between L and N test terminals
<b>R</b>	Resistance of line impedance
<b>XL</b>	Reactance of line impedance
<b>I<sub>max3p</sub></b>	Maximal three-phases prospective short-circuit current
<b>I<sub>min3p</sub></b>	Minimal three-phases prospective short-circuit current
<b>I<sub>max2p</sub></b>	Maximal two-phases prospective short-circuit current
<b>I<sub>min2p</sub></b>	Minimal two-phases prospective short-circuit current
<b>I<sub>max</sub></b>	Maximal single-phase prospective short-circuit current
<b>I<sub>min</sub></b>	Minimal single-phase prospective short-circuit current

Prospective short circuit current  $I_{PSC}$  is calculated as follows:

$$I_{PSC} = \frac{U_N \times k_{SC}}{Z}$$

where:

$U_N$ ..... Nominal  $U_{L-N}$  or  $U_{L-L}$  voltage (see table below),

$k_{SC}$  ..... Correction factor (Isc factor) for  $I_{PSC}$ . Refer to chapter **4.6.8 Settings** for more information.

$U_N$	Input voltage range (L-N or L-L)
110 V	$(93 \text{ V} \leq U_{L-N} \leq 134 \text{ V})$
230 V	$(185 \text{ V} \leq U_{L-N} \leq 266 \text{ V})$
400 V	$(321 \text{ V} \leq U_{L-L} \leq 485 \text{ V})$

Table 7.7: Relationship between Input voltage –  $U_{L-N(L)}$  and nominal voltage –  $U_N$  used for calculation

The prospective short-circuit currents  $I_{Min}$ ,  $I_{Min2p}$ ,  $I_{Min3p}$  and  $I_{Max}$ ,  $I_{Max2p}$ ,  $I_{Max3p}$  are calculated as follows:

$I_{Min} = \frac{C_{min} U_{N(L-N)}}{Z_{(L-N)hot}}$	where	$Z_{(L-N)hot} = \sqrt{(1.5 \times R_{(L-N)})^2 + X_{(L-N)}^2}$ $C_{min} = \begin{cases} 0.95; & U_{N(L-N)} = 230 V \pm 10 \% \\ 1.00; & otherwise \end{cases}$
$I_{Max} = \frac{C_{max} U_{N(L-N)}}{Z_{(L-N)}}$	where	$Z_{(L-N)} = \sqrt{R_{(L-N)}^2 + X_{(L-N)}^2}$ $C_{max} = \begin{cases} 1.05; & U_{N(L-N)} = 230 V \pm 10 \% \\ 1.10; & otherwise \end{cases}$
$I_{Min2p} = \frac{C_{min} U_{N(L-L)}}{Z_{(L-L)hot}}$	where	$Z_{(L-L)hot} = \sqrt{(1.5 \times R_{(L-L)})^2 + X_{(L-L)}^2}$ $C_{min} = \begin{cases} 0.95; & U_{N(L-L)} = 400 V \pm 10 \% \\ 1.00; & otherwise \end{cases}$
$I_{Max2p} = \frac{C_{max} U_{N(L-L)}}{Z_{(L-L)}}$	where	$Z_{(L-L)} = \sqrt{R_{(L-L)}^2 + X_{(L-L)}^2}$ $C_{max} = \begin{cases} 1.05; & U_{N(L-L)} = 400 V \pm 10 \% \\ 1.10; & otherwise \end{cases}$
$I_{Min3p} = \frac{C_{min} \times U_{N(L-L)}}{\sqrt{3}} \frac{2}{Z_{(L-L)hot}}$	where	$Z_{(L-L)hot} = \sqrt{(1.5 \times R_{(L-L)})^2 + X_{(L-L)}^2}$ $C_{min} = \begin{cases} 0.95; & U_{N(L-L)} = 400 V \pm 10 \% \\ 1.00; & otherwise \end{cases}$
$I_{Max3p} = \frac{C_{max} \times U_{N(L-L)}}{\sqrt{3}} \frac{2}{Z_{(L-L)}}$	where	$Z_{(L-L)} = \sqrt{R_{(L-L)}^2 + X_{(L-L)}^2}$ $C_{max} = \begin{cases} 1.05; & U_{N(L-L)} = 400 V \pm 10 \% \\ 1.10; & otherwise \end{cases}$

## 7.16 Z line 4W – Line impedance and prospective short-circuit current

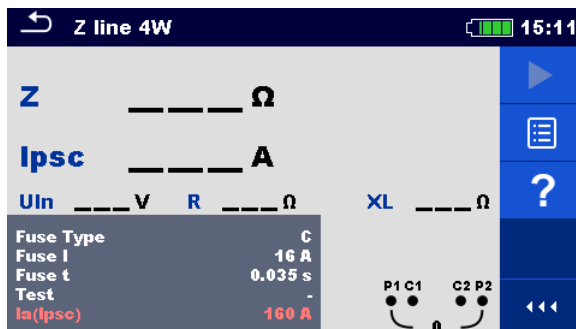

Figure 7.57: Z line 4 W measurement menu

### Measurement parameters / limits

<b>Fuse Type</b>	<b>Selection of fuse type</b> [Off, gG, NV, B, C, D, K, Custom]
<b>Fuse I</b>	<b>Rated current of selected fuse</b>
<b>Fuse t</b>	<b>Maximum breaking time of selected fuse</b>
<b>Isc factor</b>	<b>Isc factor</b> [0.20 ... 3.00]
<b>Test<sup>1)</sup></b>	<b>Test</b> [-, L/N, L/L, L1/N, L2/N, L3/N, L1/L2, L1/L3, L2/L3]
<b>Earthing system</b>	Refer to chapter <b>4.6.8 Settings</b> for more information.
<b>Ia (Ipsc)</b>	<b>Minimum short circuit current for selected fuse or custom value</b>

<sup>1)</sup> The measuring results (for phase – neutral or phase – phase line) are set according to the setting. The parameter is meant for documentation.

Refer to **Fuse tables guide** for detailed information on fuse data.

### Connection diagram

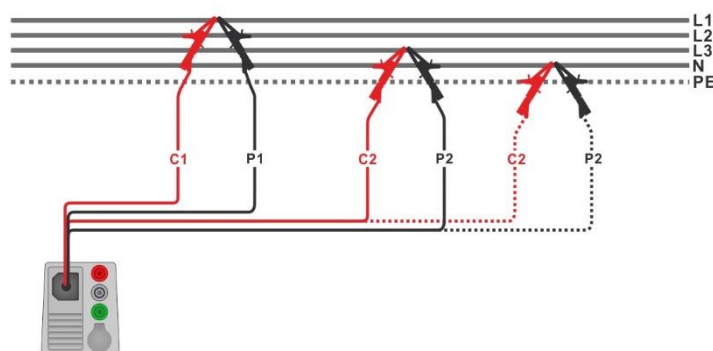

Figure 7.58: Phase-phase or phase-neutral 4-wire line impedance measurement

**Measurement procedure**

- › Enter the **Z line 4W** function.
- › Set test parameters / limits.
- › Connect test cable to the instrument.
- › Connect 4-wire test lead to the object under test, see **Figure 7.58**.
- › Start the measurement.
- › Save results (optional).



**Figure 7.59: Examples of Z line 4W measurement result**

**Measurement results / sub-results**

<b>Z</b>	Line impedance
<b>Ipsc</b>	Prospective short-circuit current
<b>Uln</b>	Voltage measured between C1 and C2 terminals
<b>R</b>	Resistance of line impedance
<b>XL</b>	Reactance of line impedance

Prospective short circuit current is calculated as follows:

$$I_{SC} = \frac{U_n \times k_{SC}}{Z}$$

where:

Un..... Nominal L-N or L-L voltage (see table below),

ksc..... Correction factor for Isc. Refer to chapter **4.6.8 Settings** for more information.

U <sub>n</sub>	Input voltage range (L-N or L-L)
110 V	(93 V ≤ U <sub>L-N</sub> < 134 V)
230 V	(185 V ≤ U <sub>L-N</sub> ≤ 266 V)
400 V	(321 V < U <sub>L-L</sub> ≤ 485 V)

**Table 7.8: Relationship between Input voltage – U<sub>L-N(L)</sub> and nominal voltage – U<sub>n</sub> used for calculation**

## 7.17 Z line mΩ – High precision line impedance and prospective short-circuit current

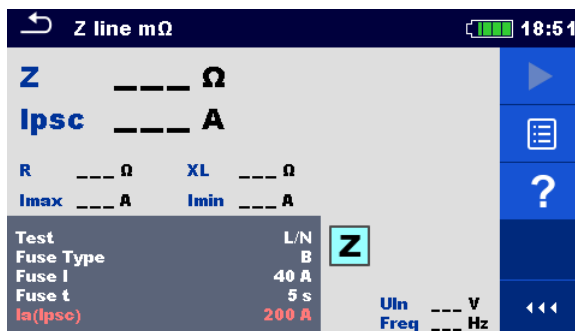

Figure 7.60: Z line mΩ menu

### Measurement parameters / limits

<b>Test</b>	Type of test [L/N, L/L]
<b>Fuse Type</b>	Selection of fuse type [Off, gG, NV, B, C, D, K, Custom]
<b>Fuse I</b>	Rated current of selected fuse
<b>Fuse t</b>	Maximum breaking time of selected fuse
<b>Ia(Ipsc)</b>	Minimum short circuit current for selected fuse or custom value
<b>Test<sup>1)</sup></b>	Test [Off, L-N, L/L, L1-N, L2-N, L3-N, L1-L2, L1-L3, L2-L3]

<sup>1)</sup> The measuring results (for phase – neutral or phase – phase line) are set according to the setting. The parameter is meant for documentation.

Refer to **Fuse tables guide** for detailed information on fuse data.

### Connection diagram

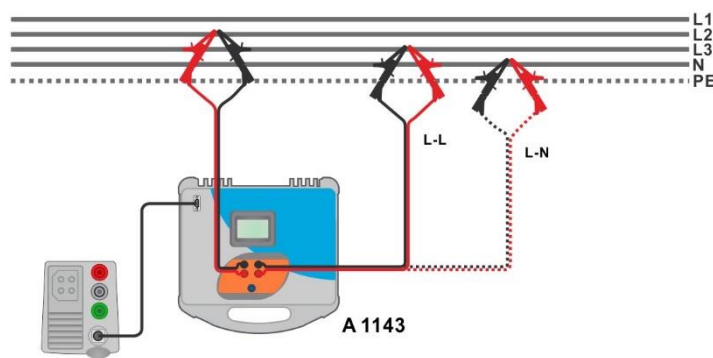



Figure 7.61: Phase-neutral or phase-phase high precision Line impedance measurement – Connection of A 1143

**Measurement procedure**

- › Enter the **Z line mΩ** function.
  - › Set test parameters / limits.
  - › Connect test leads to A 1143 – Euro Z 290 A adapter and switch it on.
  - › Connect A 1143 – Euro Z 290 A adapter to the instrument using RS232-PS/2 cable.
  - › Connect test leads to the object under test, see **Figure 7.61**.
- 
- › Start the measurement using  or  button.
  - › Save results (optional).

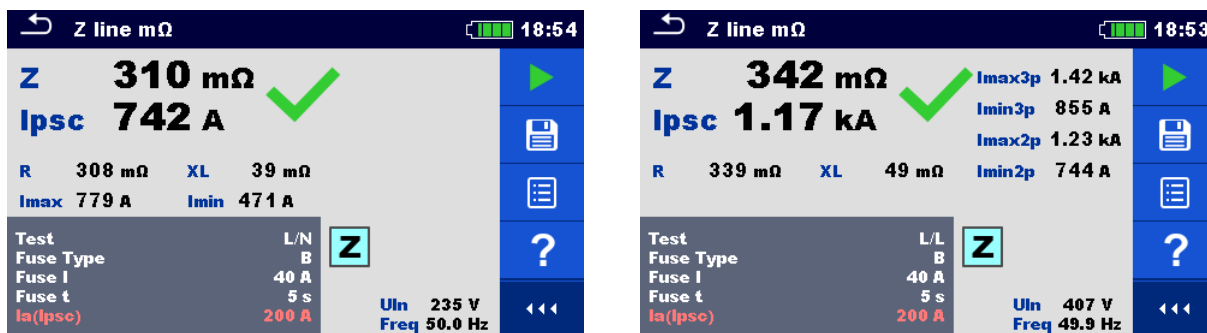

Figure 7.62: Examples of high precision Line impedance measurement result

**Measurement results / sub-results**

<b>Z</b>	Line impedance
<b>Ipsc</b>	Standard prospective short-circuit current
<b>Imax</b>	Maximal prospective short-circuit current
<b>Imin</b>	Minimal prospective short-circuit current
<b>Imax2p</b>	Maximal two-phases prospective short-circuit current
<b>Imin2p</b>	Minimal two-phases prospective short-circuit current
<b>Imax3p</b>	Maximal three-phases prospective short-circuit current
<b>Imin3p</b>	Minimal three-phases prospective short-circuit current
<b>R</b>	Resistance of line impedance
<b>XL</b>	Reactance of line impedance
<b>Uln</b>	Voltage L-N or L-L
<b>Freq</b>	Frequency

Standard prospective short-circuit current  $I_{PSC}$  is calculated as follows:

$$I_{PSC} = \frac{230 V}{Z} \quad \text{where} \quad U_{L-N} = 230 V \pm 10 \%$$

$$I_{PSC} = \frac{400 V}{Z} \quad \text{where} \quad U_{L-L} = 400 V \pm 10 \%$$

The prospective short-circuit currents  $I_{Min}$ ,  $I_{Min2p}$ ,  $I_{Min3p}$  and  $I_{Max}$ ,  $I_{Max2p}$ ,  $I_{Max3p}$  are calculated as follows:

$I_{Min} = \frac{C_{min} U_{N(L-N)}}{Z_{(L-N)hot}}$	where	$Z_{(L-N)hot} = \sqrt{(1.5 \times R_{(L-N)})^2 + X_{(L-N)}^2}$ $C_{min} = \begin{cases} 0.95; & U_{N(L-N)} = 230 V \pm 10 \% \\ 1.00; & otherwise \end{cases}$
$I_{Max} = \frac{C_{max} U_{N(L-N)}}{Z_{(L-N)}}$	where	$Z_{(L-N)} = \sqrt{R_{(L-N)}^2 + X_{(L-N)}^2}$ $C_{max} = \begin{cases} 1.05; & U_{N(L-N)} = 230 V \pm 10 \% \\ 1.10; & otherwise \end{cases}$
$I_{Min2p} = \frac{C_{min} U_{N(L-L)}}{Z_{(L-L)hot}}$	where	$Z_{(L-L)hot} = \sqrt{(1.5 \times R_{(L-L)})^2 + X_{(L-L)}^2}$ $C_{min} = \begin{cases} 0.95; & U_{N(L-L)} = 400 V \pm 10 \% \\ 1.00; & otherwise \end{cases}$
$I_{Max2p} = \frac{C_{max} U_{N(L-L)}}{Z_{(L-L)}}$	where	$Z_{(L-L)} = \sqrt{R_{(L-L)}^2 + X_{(L-L)}^2}$ $C_{max} = \begin{cases} 1.05; & U_{N(L-L)} = 400 V \pm 10 \% \\ 1.10; & otherwise \end{cases}$
$I_{Min3p} = \frac{C_{min} \times U_{N(L-L)}}{\sqrt{3}} \frac{2}{Z_{(L-L)hot}}$	where	$Z_{(L-L)hot} = \sqrt{(1.5 \times R_{(L-L)})^2 + X_{(L-L)}^2}$ $C_{min} = \begin{cases} 0.95; & U_{N(L-L)} = 400 V \pm 10 \% \\ 1.00; & otherwise \end{cases}$
$I_{Max3p} = \frac{C_{max} \times U_{N(L-L)}}{\sqrt{3}} \frac{2}{Z_{(L-L)}}$	where	$Z_{(L-L)} = \sqrt{R_{(L-L)}^2 + X_{(L-L)}^2}$ $C_{max} = \begin{cases} 1.05; & U_{N(L-L)} = 400 V \pm 10 \% \\ 1.10; & otherwise \end{cases}$

Refer to **A 1143 – Euro Z 290 A adapter Instruction manual** for detailed information.

## 7.18 Voltage Drop

The voltage drop is calculated based on the difference of line impedance at connection points (sockets) and the line impedance at the reference point (usually the impedance at the switchboard).

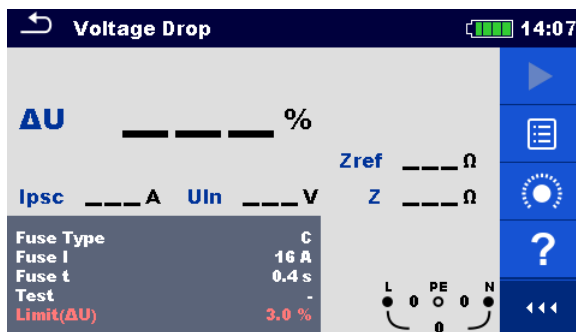

Figure 7.63: Voltage drop menu

### Measurement parameters / limits

<b>Fuse Type</b>	Selection of fuse type [Off, gG, NV, B, C, D, K, Custom]
<b>Fuse I</b>	Rated current of selected fuse
<b>Fuse t</b>	Maximum breaking time of selected fuse
<b>I (ΔU)<sup>1)</sup></b>	Rated current for ΔU measurement (custom value)
<b>Isc factor</b>	Isc factor [0.20 ... 3.00]
<b>Test<sup>2)</sup></b>	Test [-, L/N, L/L, L1/N, L2/N, L3/N, L1/L2, L1/L3, L2/L3]
<b>Earthing system</b>	Refer to chapter <b>4.6.8 Settings</b> for more information.
<b>Limit(ΔU)</b>	Maximum voltage drop [3.0 % ... 9.0 %]

<sup>1)</sup> Applicable if Fuse type is set to Off or Custom

<sup>2)</sup> With Plug test cable or Plug commander Voltage drop is measured in the same way regardless of the setting. The parameter is meant for documentation.

Refer to **Fuse tables guide** for detailed information on fuse data.

### Connection diagram

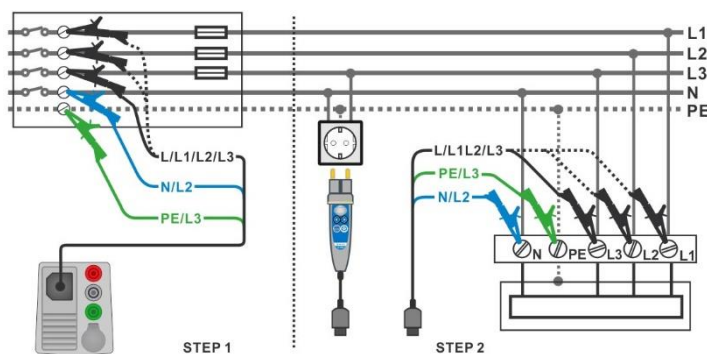



Figure 7.64: Voltage drop measurement – connection of Plug commander and 3-wire test lead



## Measurement procedure

### STEP 1: Measuring the impedance Zref at origin

- › Enter the **Voltage Drop** function.
- › Set test parameters / limits.
- › Connect test cable to the instrument.
- › Connect 3-wire test lead to the origin of electrical installation, see **Figure 7.64**.
- › Touch or select the  icon to initiate Zref measurement.
- › Press the  button to measure Zref.

### STEP 2: Measuring the Voltage drop

- › Enter the **Voltage Drop** function.
- › Set test parameters / limits.
- › Connect test cable to the instrument.
- › Connect 3-wire test lead or Plug commander to the tested points, see **Figure 7.64**.
- › Start the measurement.
- › Save results (optional).

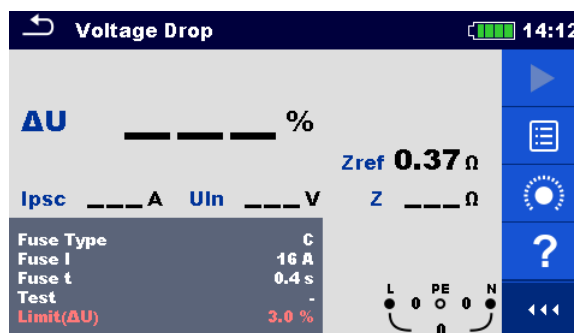

Figure 7.65: Example of Zref measurement result (Step 1)

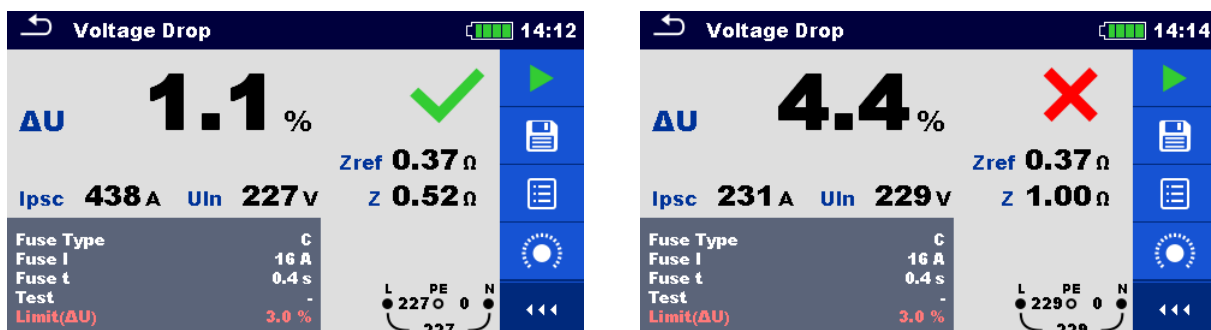

Figure 7.66: Examples of Voltage drop measurement result (Step 2)

**Measurement results / sub-results**

<b><math>\Delta U</math></b>	Voltage drop
<b><math>I_{psc}</math></b>	Prospective short-circuit current
<b><math>U_{ln}</math></b>	Voltage L-N
<b><math>Z_{ref}</math></b>	Reference line impedance
<b><math>Z</math></b>	Line impedance

Voltage drop is calculated as follows:

$$\Delta U[\%] = \frac{(Z - Z_{REF}) \cdot I_N}{U_N} \cdot 100$$

where:

<b><math>\Delta U</math></b>	Calculated Voltage drop
<b><math>Z_{ref}</math></b>	Impedance at reference point (at origin)
<b><math>Z</math></b>	Impedance at test point
<b><math>U_n</math></b>	Nominal voltage
<b><math>I_n</math></b>	Rated current of selected fuse (Fuse I) or custom value I ( $\Delta U$ )

<b><math>U_n</math></b>	<b>Input voltage range (L-N or L-L)</b>
110 V	$(93 \text{ V} \leq U_{L-N} \leq 134 \text{ V})$
230 V	$(185 \text{ V} \leq U_{L-N} \leq 266 \text{ V})$
400 V	$(321 \text{ V} \leq U_{L-L} \leq 485 \text{ V})$

**Table 7.9: Relationship between Input voltage –  $U_{L-N(L)}$  and nominal voltage –  $U_n$  used for calculation**

## 7.19 Z auto - Auto test sequence for fast line and loop testing

Tests / measurements implemented in Z auto test sequence

Voltage

Z line

Voltage Drop

Zs rcd

Uc

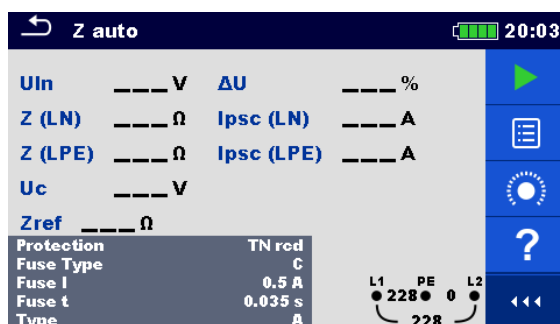

Figure 7.67: Z auto menu

### Measurement parameters / limits

<b>Protection</b>	<b>Protection type</b> [TN, TNrcd, TTrcd]
<b>Fuse type</b>	<b>Selection of fuse type</b> [Off, gG, NV, B, C, D, K, Custom]
<b>Fuse I</b>	<b>Rated current of selected fuse</b>
<b>Fuse t</b>	<b>Maximum breaking time of selected fuse</b>
<b>I (ΔU)<sup>1)</sup></b>	<b>Rated current for ΔU measurement (custom value)</b>
<b>Isc factor</b>	<b>Isc factor</b> [0.20 ... 3.00]
<b>RCD Type</b>	<b>RCD type</b> [AC, A, F, B, B+]
<b>I ΔN</b>	<b>Rated RCD residual current sensitivity</b> [10 mA, 15 mA, 30 mA, 100 mA, 300 mA, 500 mA, 1000 mA]
<b>Selectivity</b>	<b>Characteristic</b> [G, S]
<b>Phase<sup>2)</sup></b>	<b>Selection of test</b> [-, L1, L2, L3]
<b>I test</b>	<b>Test current</b> [Standard, Low]
<b>Limit(ΔU)</b>	<b>Maximum voltage drop</b> [3.0 % ... 9.0 %]
<b>Limit (Rpe)</b>	<b>Max. resistance</b> [Off, 0.1 Ω ... 20.0 Ω]
<b>Ia(Ipssc (LN)) Ipssc (LPE)<sup>3)</sup></b>	<b>Minimum short circuit current for selected fuse or custom value</b>
<b>Limit Uc</b>	<b>Conventional touch voltage limit</b> [12 V, 25 V, 50 V]

<sup>1)</sup> Applicable if Fuse type is set to Off or Custom.

<sup>2)</sup> With Plug test cable or Plug commander RCD tests are measured in the same way regardless of the setting. The parameter is meant for documentation.

<sup>3)</sup> Ipssc (LPE) is considered if Protection is set to TNrcd. Ipssc(LN) is always considered.

Refer to **Fuse tables guide** for detailed information on fuse data.

## Connection diagram

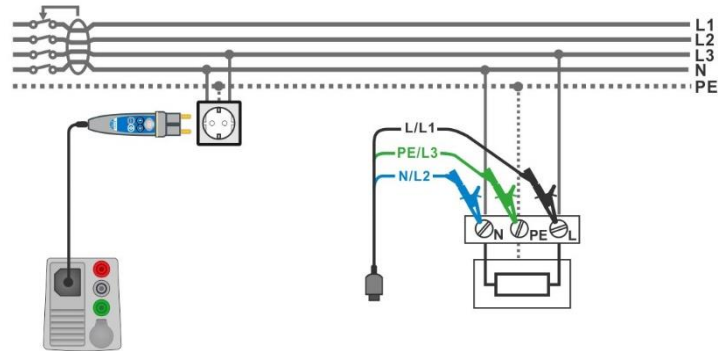

Figure 7.68: Z auto measurement

## Measurement procedure

- ▶ Enter the **Z auto** function.
- ▶ Set test parameters / limits.
- ▶ Measure the impedance  $Z_{ref}$  at origin (optional), see chapter **7.18 Voltage Drop**.
- ▶ Connect test cable to the instrument.
- ▶ Connect 3 wire - test lead or Plug commander to the object under test, see **Figure 7.68**.
- ▶ Start the Auto test.
- ▶ Save results (optional).



Figure 7.69: Examples of Zauto measurement results

## Measurement results / sub-results

<b>UIn</b>	Voltage between phase and neutral conductors
<b>ΔU</b>	Voltage drop
<b>Z (LN)</b>	Line impedance
<b>Z (LPE)</b>	Loop impedance
<b>Zref</b>	Reference line impedance
<b>Ipsc (LN)</b>	Prospective short-circuit current
<b>Ipsc (LPE)</b>	Prospective fault current
<b>Uc</b>	Contact voltage

## 7.20 Earth – Earth resistance (3-wire test)

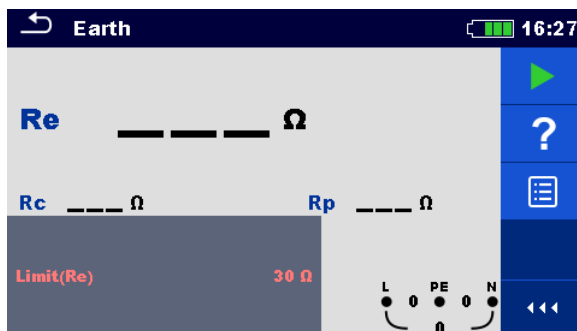

Figure 7.70: Earth menu

### Measurement parameters / limits

**Limit(Re)** Maximum resistance [Off, 1 Ω ... 5 kΩ]

### Connection diagrams

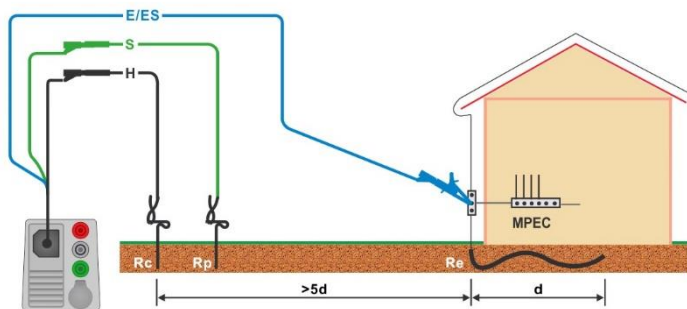

Figure 7.71: Resistance to earth, measurement of main installation earthing

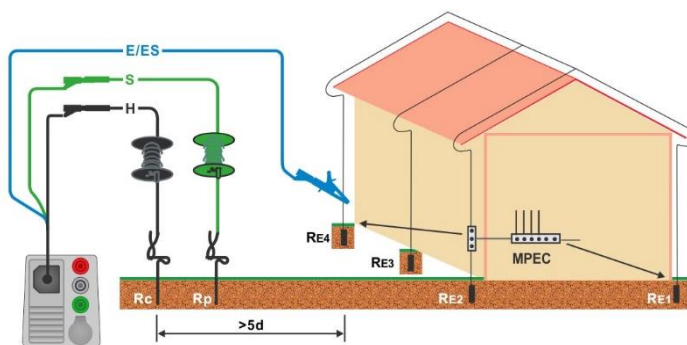

Figure 7.72: Resistance to earth, measurement of a lighting protection system

### Measurement procedure

- › Enter the **Earth** function.
- › Set test parameters / limits.
- › Connect test cable to the instrument.
- › Connect 3-wire test lead to the object under test, see **Figure 7.71** and **Figure 7.72**.
- › Start the measurement.
- › Save results (optional).

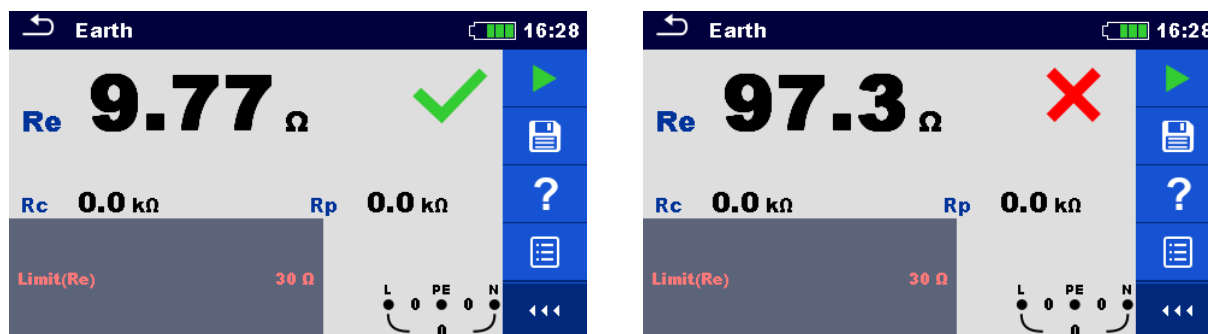

Figure 7.73: Examples of Earth resistance measurement result

### Measurement results / sub-results

<b>Re</b>	Earth resistance
<b>Rc</b>	Resistance of H (current) probe
<b>Rp</b>	Resistance of S (potential) probe

## 7.21 Earth 2 clamp – Contactless earthing resistance measurement (with two current clamps)

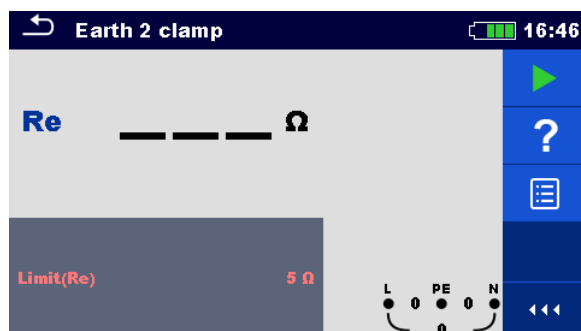

Figure 7.74: Earth 2 clamps menu

### Measurement parameters / limits

Limit(Re) Maximum resistance [Off, 1 Ω ... 30 Ω]

### Connection diagram

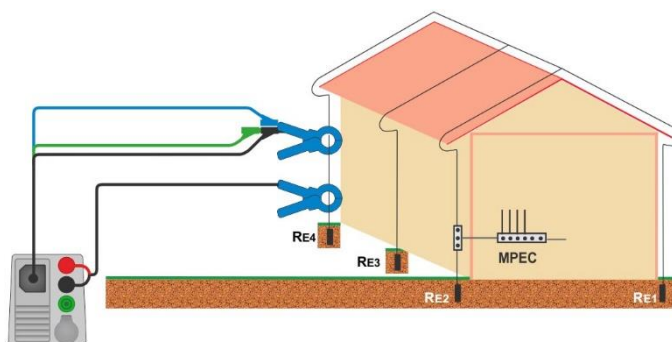

Figure 7.75: Contactless earthing resistance measurement

### Measurement procedure

- › Enter the **Earth 2 clamp** function.
- › Set test parameters / limits.
- › Connect test cable and clamps to the instrument.
- › Clamp on object under test, see **Figure 7.75**.
- › Start the continuous measurement.
- › Stop the measurement.
- › Save results (optional).

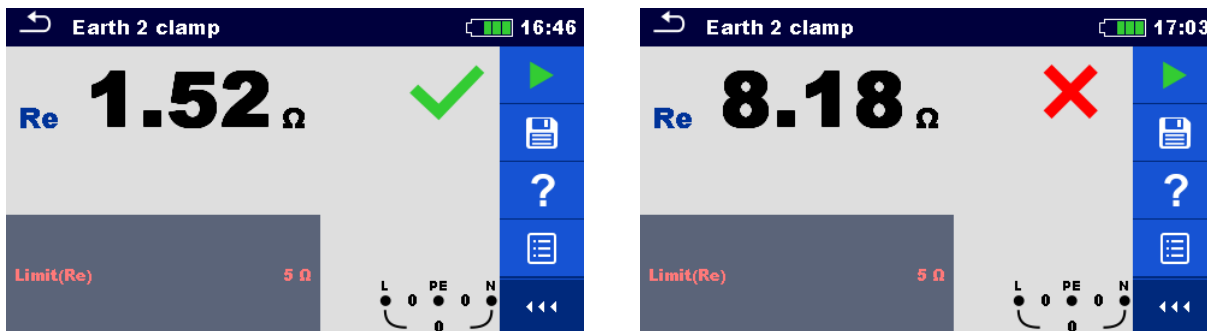

Figure 7.76: Examples of Contactless earthing resistance measurement result

Measurement results / sub-results

Re	Earth resistance
----	------------------

### 7.22 Ro – Specific earth resistance

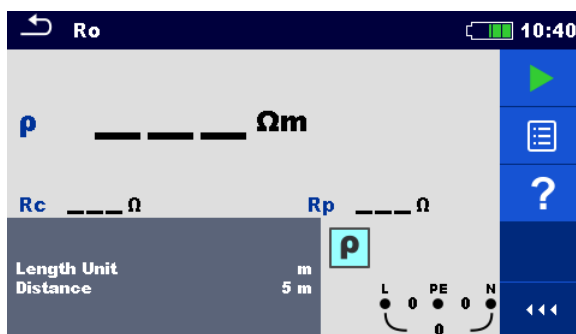

Figure 7.77: Earth Ro menu

Measurement parameters / limits

Length Unit	Length unit [m, ft]
Distance	Distance between probes [0.1 m ... 29.9 m] or [1 ft ... 100 ft]

Connection diagram

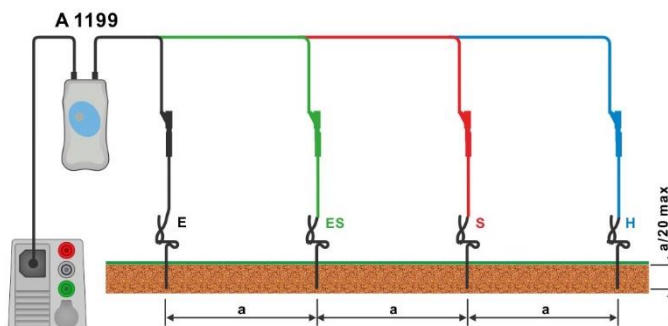

Figure 7.78: Specific earth resistance measurement



### Measurement procedure

- › Enter the **Ro** function.
- › Set test parameters / limits.
- › Connect A 1199 adapter to the instrument.
- › Connect test leads to earth probes, see **Figure 7.78**.
- › Start the measurement.
- › Save results (optional).

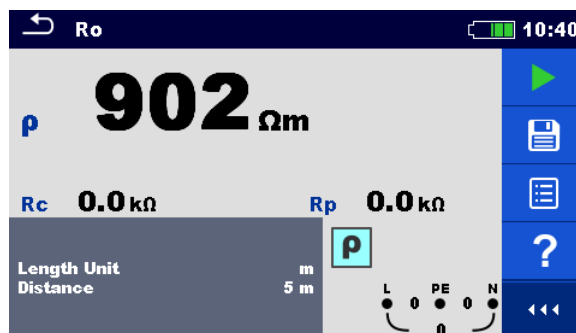

Figure 7.79: Example of Specific earth resistance measurement result

### Measurement results / sub-results

$\rho$	Specific earth resistance
<b>Rc</b>	Resistance of H, E (current) probe
<b>Rp</b>	Resistance of S, ES (potential) probe

## 7.23 Power

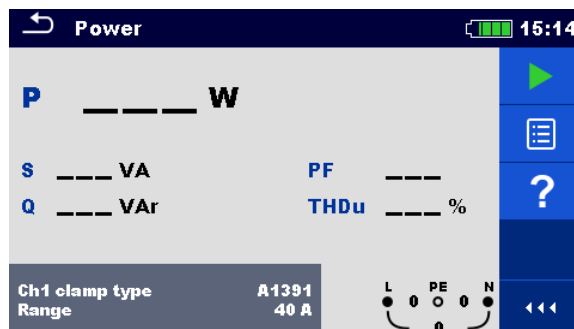

Figure 7.80: Power menu

### Measurement parameters / limits

Ch1 clamp type	Current clamp adapter [A1018, A1019, A1391]
Range	Range for selected current clamp adapter
	A1018 [20 A]
	A1019 [20 A]
	A1391 [40 A, 300 A]

### Connection diagram

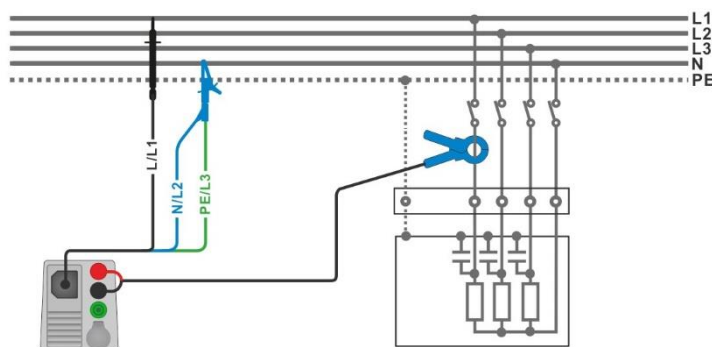

Figure 7.81: Power measurement

### Measurement procedure

- › Enter the **Power** function.
- › Set parameters / limits.
- › Connect the 3-wire test lead and current clamp to the instrument.
- › Connect the 3-wire test lead and current clamp to the item to be tested (see **Figure 7.81**).
- › Start the continuous measurement.
- › Stop the measurement.
- › Save results (optional).

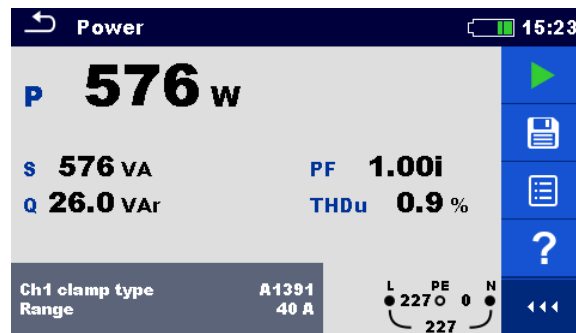

Figure 7.82: Example of Power measurement result

### Measurement results / sub-results

<b>P</b>	Active power
<b>S</b>	Apparent power
<b>Q</b>	Reactive power (capacitive or inductive)
<b>PF</b>	Power factor (capacitive or inductive)
<b>THDu</b>	Voltage total harmonic distortion

## 7.24 Harmonics

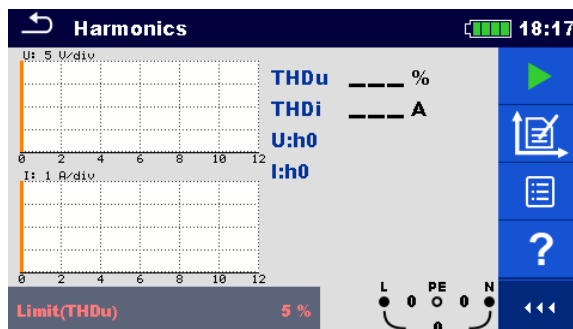

Figure 7.83: Harmonics menu

### Measurement parameters / limits

<b>Ch1 clamp type</b>	<b>Current clamp adapter [A1018, A1019, A1391]</b>
<b>Range</b>	<b>Range for selected current clamp adapter</b> A1018 [20 A] A1019 [20 A] A1391 [40 A, 300 A]
<b>Limit(THDu)</b>	<b>Max. THD of voltage [3 % ... 10 %]</b>

### Connection diagram

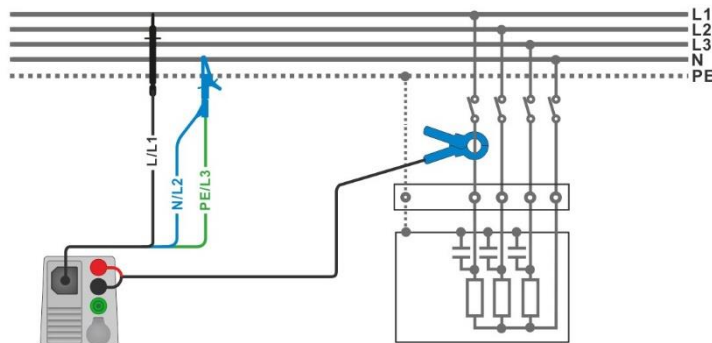

Figure 7.84: Harmonics measurement

### Measurement procedure

- ▶ Enter the **Harmonics** function.
- ▶ Set parameters / limits.
- ▶ Connect 3-wire test lead and current clamp to the instrument.
- ▶ Connect 3-wire test lead and current clamp to the item to be tested, see **Figure 7.84**.
- ▶ Start the continuous measurement.
- ▶ Stop the measurement.
- ▶ Save results (optional).

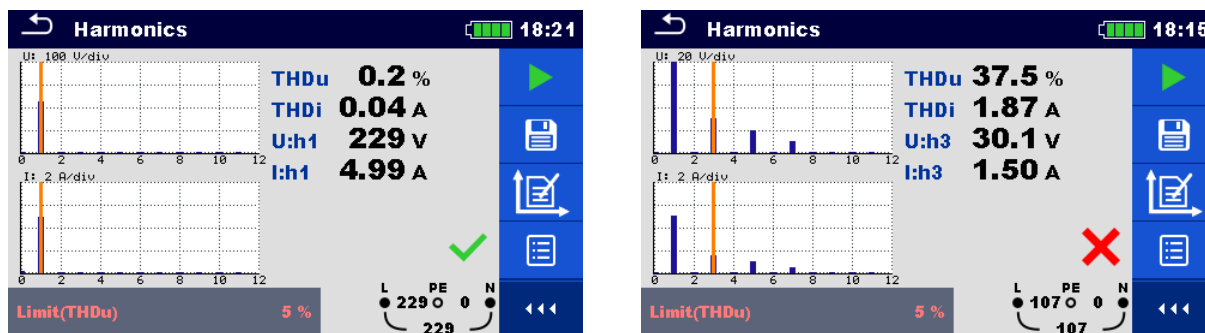

Figure 7.85: Examples of Harmonics measurement results

Measurement results / sub-results

<b>U:h(i)</b>	TRMS voltage of selected harmonic [h0 ... h11]
<b>I:h(i)</b>	TRMS current of selected harmonic [h0 ... h11]
<b>THDu</b>	Voltage total harmonic distortion
<b>THDi</b>	Current total harmonic distortion

## 7.25 Currents

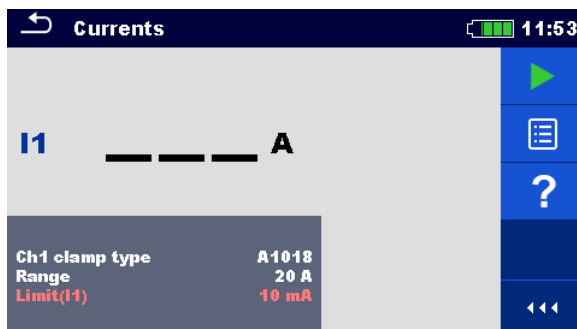

Figure 7.86: Current menu

### Measurement parameters / limits

<b>Ch1 clamp type</b>	<b>Current clamp adapter [A1018, A1019, A1391]</b>
<b>Range</b>	<b>Range for selected current clamp adapter</b> A1018 [20 A] A1019 [20 A] A1391 [40 A, 300 A]
<b>Limit(I1) <sup>1)</sup></b>	<b>Max. differential leakage [Off, 0.1 mA ... 100 mA]</b>

<sup>1)</sup>Limit(I1) setting is omitted, if Ch1 clamp type is set to A1391.

### Connection diagram

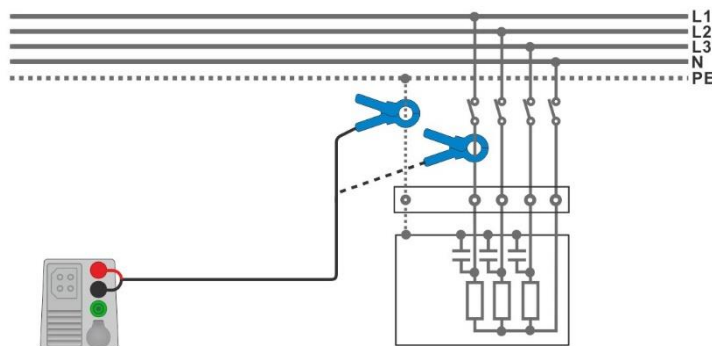

Figure 7.87: PE leakage and load current measurements

### Measurement procedure

- › Enter the **Currents** function.
- › Set parameters / limits.
- › Connect the current clamp to the instrument.
- › Connect the clamp to the object under test, see **Figure 7.87**.
- › Start the continuous measurement.
- › Stop the measurement.
- › Save results (optional).

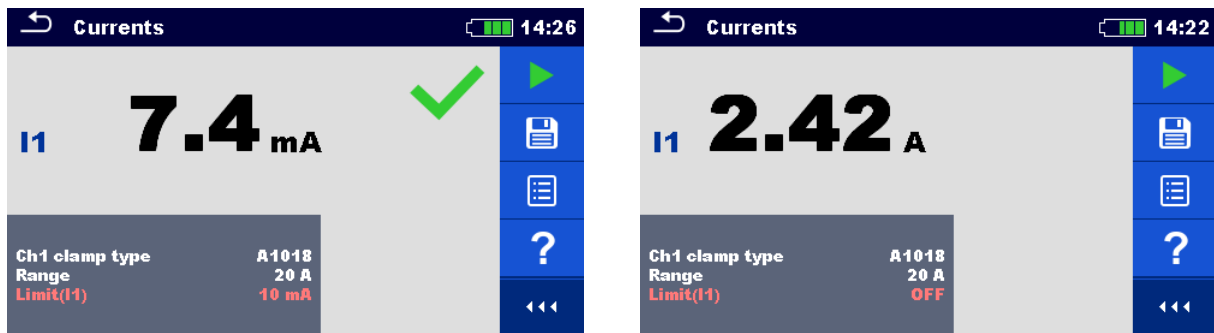

Figure 7.88: Examples of Current measurement result

### Measurement results / sub-results

I1 PE leakage or load current

### 7.26 ISFL – First fault leakage current

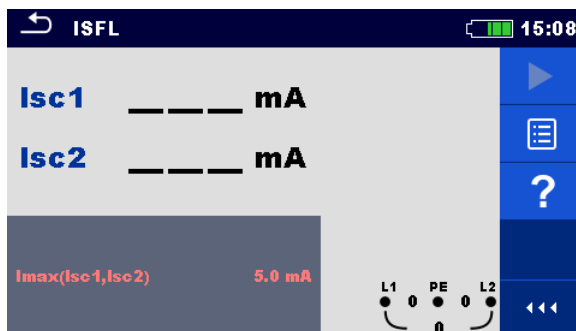

Figure 7.89: ISFL measurement menu

#### Measurement parameters / limits

**Imax(Isc1, Isc2)** Maximum first fault leakage current [Off, 3.0 mA ... 19.5 mA]

#### Connection diagrams

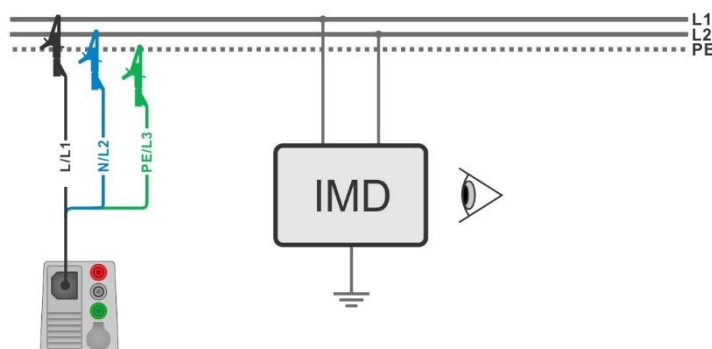

Figure 7.90: Measurement of highest First fault leakage current with 3-wire test lead

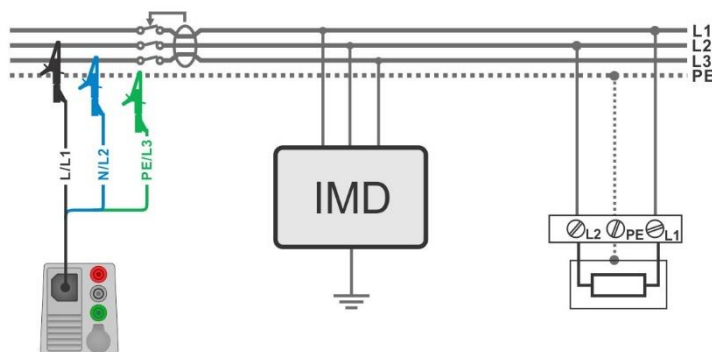

Figure 7.91: Measurement of First fault leakage current for RCD protected circuit with 3-wire test lead



### Measurement procedure

- › Enter the **ISFL** function.
- › Set test parameters / limits.
- › Connect test cable to the instrument.
- › Connect 3-wire test lead to the object under test, see *Figure 7.90* and *Figure 7.91*.
- › Start the measurement.
- › Save results (optional).



Figure 7.92: Examples of First fault leakage current measurement result

### Measurement results / sub-results

<b>I<sub>sc1</sub></b>	First fault leakage current at single fault between L1/PE
<b>I<sub>sc2</sub></b>	First fault leakage current at single fault between L2/PE

## 7.27 IMD – Testing of insulation monitoring devices

This function checks the alarm threshold of insulation monitor devices (IMD) by applying a changeable resistance between L1/PE and L2/PE terminals.

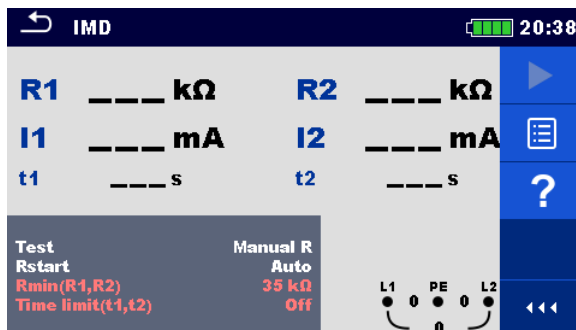

Figure 7.93: IMD test menu

### Test parameters / limits

<b>Test</b>	<b>Test mode</b> [MANUAL R, MANUAL I, AUTO R, AUTO I]
<b>Rstart</b>	<b>Starting insulation resistance</b> [Auto, 5 kΩ ... 640 kΩ]
<b>Istart</b>	<b>Starting fault current</b> [Auto, 0.1 mA ... 19.9 mA]
<b>t step</b>	<b>Timer (AUTO R and AUTO I test modes)</b> [1 s ... 99 s]
<b>Rmin(R1,R2)</b>	<b>Min. insulation resistance (R<sub>LIMIT</sub>)</b> [Off, 5 kΩ ... 640 kΩ]
<b>I<sub>max</sub>(I1,I2)</b>	<b>Max. fault current (I<sub>LIMIT</sub>)</b> [Off, 0.1 mA ... 19.9 mA]
<b>Time limit (t1, t2)</b>	<b>Max. activation / disconnection time limit</b> [Off, 1 s, custom]

### Connection diagram

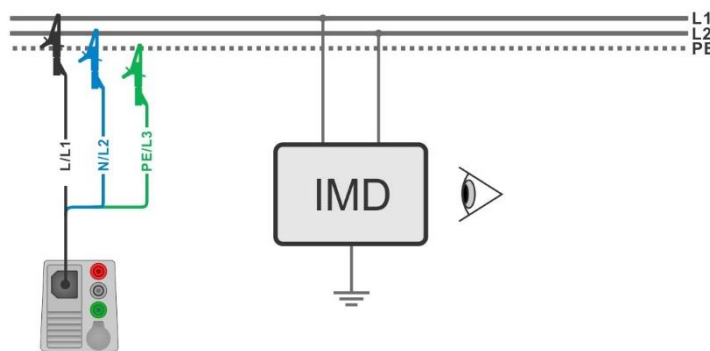











Figure 7.94: Connection with 3-wire test lead



**Test procedure (MANUAL R, MANUAL I)**

- › Enter the **IMD** function.
- › Set test parameter to MANUAL R or MANUAL I.  
Set other test parameters / limits.
- › Connect test cable to the instrument.
- › Connect 3-wire test lead to the object under test, see **Figure 7.94**.
- › Start the measurement.



- › Use the   or   keys to change insulation resistance<sup>1)</sup> until IMD alarms an insulation failure for L1.

- › Press  or the  key to change line terminal selection to L2.  
(If IMD switches off voltage supply, instrument automatically changes line terminal selection to L2 and proceeds with the test when supply voltage is detected.)

- › Use the   or   keys to change insulation resistance<sup>1)</sup> until IMD alarms an insulation failure for L2.

- › Press the  or the  key.  
(If IMD switches off voltage supply, instrument automatically proceeds to the PASS / FAIL / NO STATUS indication.)



- › Use  to select PASS / FAIL / NO STATUS indication.

- › Press  or the  key to confirm selection and complete the measurement.
- › Save results (optional).

**Test procedure (AUTO R, AUTO I)**

- › Enter the **IMD** function.
- › Set test parameter to AUTO R or AUTO I.
- › Set other test parameters / limits.
- › Connect test cable to the instrument.
- › Connect 3-wire test lead to the object under test, see **Figure 7.94**.
- › Start the measurement.  
Insulation resistance between L1-PE is decreased automatically according to limit value<sup>1)</sup> every time interval selected with timer. To speed up the test press the

  or   keys until IMD alarms an insulation failure for L1.



- › Press  or the  key to change line terminal selection to L2.

(If IMD switches off voltage supply, instrument automatically changes line terminal selection to L2 and proceeds with the test when supply voltage is detected.)

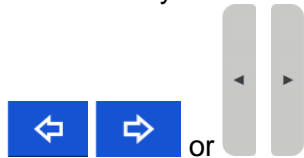

- Insulation resistance between L2-PE is decreased automatically according to limit value<sup>1)</sup> every time interval selected with timer. To speed up the test press the



keys until IMD alarms an insulation failure for L2.

- Press the  or the  key. If IMD switches off voltage supply, instrument automatically proceeds to the PASS / FAIL / NO STATUS indication.

- Use  to select PASS / FAIL / NO STATUS indication.

- Press  or the  key to confirm selection and complete the measurement.

- Save results (optional).

<sup>\*)</sup> Starting and ending insulation resistances are determined by selection of IMD test sub-function and test parameters. See tables below:

Sub-function	Rstart parameter	Starting insulation resistance value	Ending insulation resistance value
MANUAL R	Auto	$R_{START} \cong 1.5 \times R_{LIMIT}$	-
	[5 kΩ ... 640 kΩ]	$R_{START} = R_{start}$	-
AUTO R	Auto	$R_{START} \cong 1.5 \times R_{LIMIT}$	$R_{END} \cong 0.5 \times R_{LIMIT}$
	[5 kΩ ... 640 kΩ]	$R_{START} = R_{start}$	$R_{END} \cong 0.5 \times R_{START}$

**Table 7.10: Starting / ending insulation resistance values for MANUAL R and AUTO R sub-functions**

Sub-function	Istart parameter	Starting insulation resistance value	Ending insulation resistance value
MANUAL I	Auto	$R_{START} \cong 1.5 \times \frac{U_{L1-L2}}{I_{LIMIT}}$	-
	[0.1 mA ... 19.9 mA]	$R_{START} \cong \frac{U_{L1-L2}}{I_{start}}$	-
AUTO I	Auto	$R_{START} \cong 1.5 \times \frac{U_{L1-L2}}{I_{LIMIT}}$	$R_{END} \cong 0.5 \times \frac{U_{L1-L2}}{I_{LIMIT}}$
	[0.1 mA ... 19.9 mA]	$R_{START} \cong \frac{U_{L1-L2}}{I_{start}}$	$R_{END} \cong 0.5 \times \frac{U_{L1-L2}}{I_{start}}$

**Table 7.11: Starting / ending insulation resistance values for MANUAL I and AUTO I sub-functions**

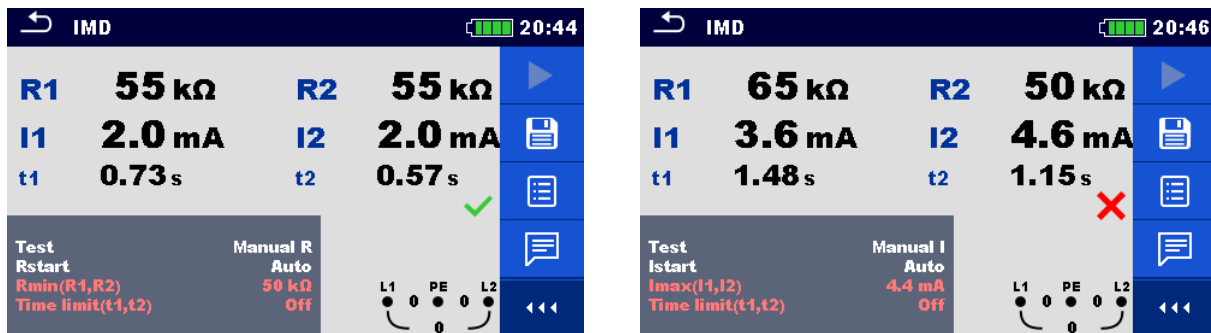

Figure 7.95: Examples of IMD test result

### Test results / sub-results

<b>R1</b>	Threshold insulation resistance between L1-PE
<b>I1</b>	Calculated first fault leakage current for R1
<b>t1</b>	Activation / disconnection time of IMD for R1
<b>R2</b>	Threshold insulation resistance between L2-PE
<b>I2</b>	Calculated first fault leakage current for R2
<b>t2</b>	Activation / disconnection time of IMD for R2

Calculated first fault leakage current at threshold insulation resistance is given as  $I_{1(2)} = \frac{U_{L1-L2}}{R_{1(2)}}$ , where  $U_{L1-L2}$  is line-line voltage. The calculated first fault current is the maximum current that would flow when insulation resistance decreases to the same value as the applied test resistance, and a first fault is assumed between opposite line and PE.

If any of the activation / disconnection time result (t1, t2) is out of set limit, overall status of the test is “failed” and cannot be modified manually. Otherwise overall status can be user defined. If activation of IMD device is visual indication and/or audio alert, without voltage disconnection, Time limit (t1,t2) parameter should be set to “Off” to disable timing limitation.

### 7.28 Rpe – PE conductor resistance



Figure 7.96: PE conductor resistance measurement menu

#### Measurement parameters / limits

<b>Bonding</b>	[Rpe, Local]
<b>RCD</b>	[Yes, No]
<b>Limit(Rpe)</b>	<b>Max. resistance</b> [Off, 0.1 Ω ... 20.0 Ω]

#### Connection diagram

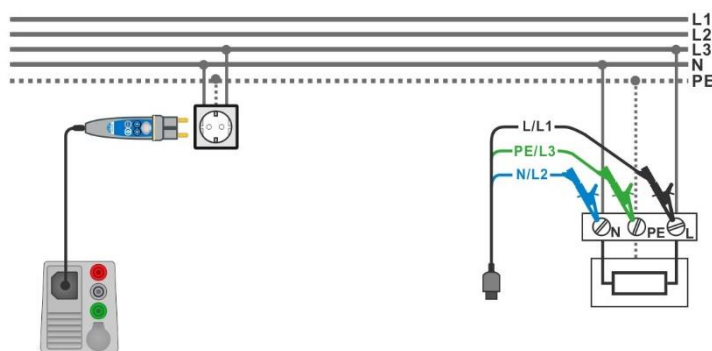

Figure 7.97: Connection of Plug commander and 3-wire test lead

## Measurement procedure

- › Enter the **Rpe** function.
- › Set test parameters / limits.
- › Connect test cable to the instrument.
- › Connect 3-wire test lead or Plug commander to the object under test, see **Figure 7.97**.
- › Start the measurement.
- › Save results (optional).

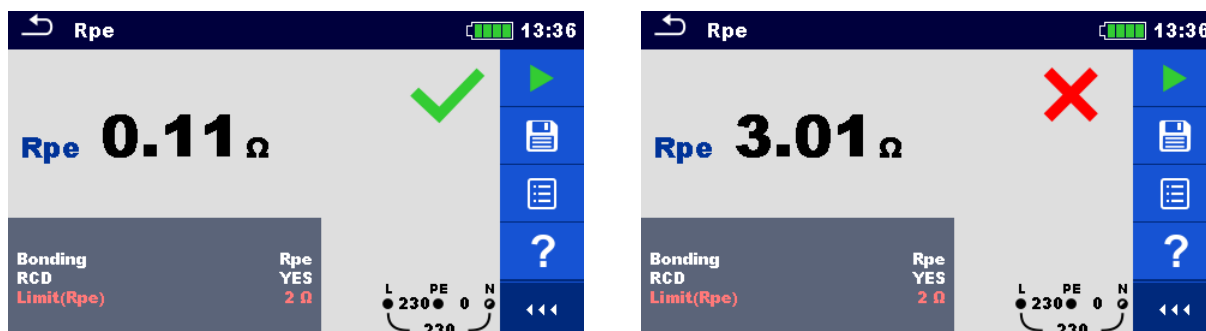

Figure 7.98: Examples of PE conductor resistance measurement result

## Measurement results / sub-results

**Rpe** PE conductor resistance

## 7.29 Illumination

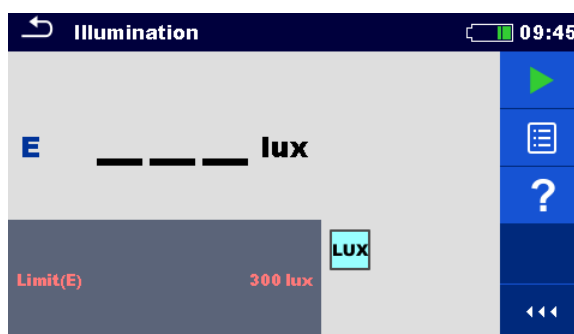

Figure 7.99: Illumination measurement menu

### Measurement parameters / limits

**Limit(E) Minimum illumination** [Off, 0.1 lux ... 20 klux]

### Probe positioning

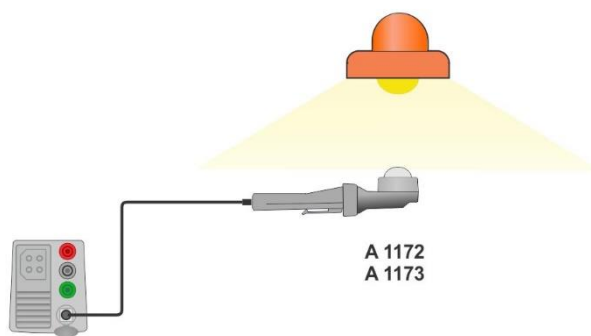

Figure 7.100: LUXmeter probe positioning

### Measurement procedure

- › Enter the **Illumination** function.
- › Set test parameters / limits.
- › Connect illumination sensor A 1172 or A 1173 to the instrument.
- › Take the position of LUXmeter probe, see **Figure 7.100**.  
Make sure that LUXmeter probe is turned on.
- › Start the continuous measurement.
- › Stop the measurement.
- › Save results (optional).



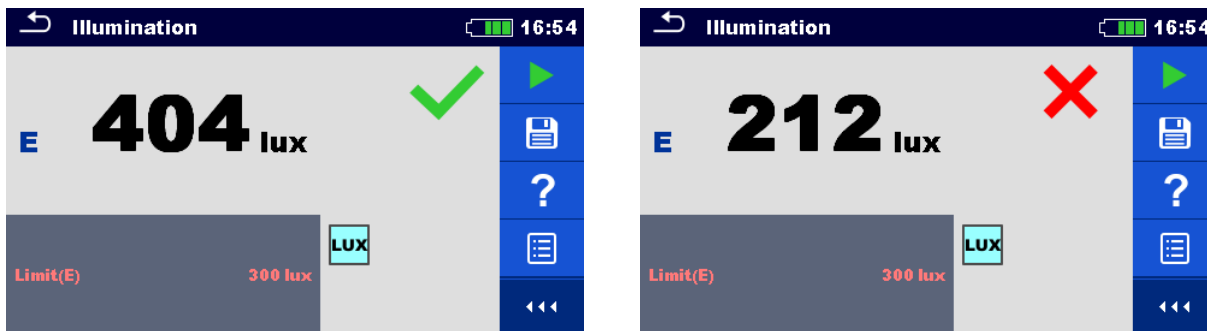

Figure 7.101: Examples of Illumination measurement result

Measurement results / sub-results

E Illumination

### 7.30 Discharging time

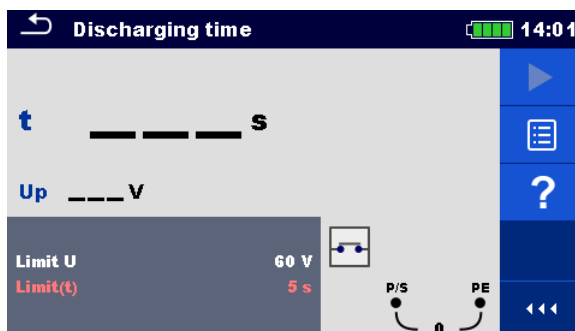

Figure 7.102: Discharging time measurement menu

Measurement parameters / limits

Limit U	Voltage limit [34 V, 60 V, 120 V]
Limit (t)	Time limit [1 s, 5 s]

Measuring principle

The measuring principle of the discharging time function is as following:

- Step 1:** The DUT is connected to supply voltage via an external socket. The instrument monitors the voltage (on supply or internal connections) and internally stores the peak voltage value.
- Step 2:** The DUT is disconnected from the supply and the voltage at the test terminals starts to fall. Once the rms voltage falls for 10 V the instrument starts to measure time.
- Step 3:** After the voltage drops below an internally calculated voltage value the timer is stopped. The instrument re-calculates the measured time to a value as it would be if the disconnection occurred at the maximum voltage value.

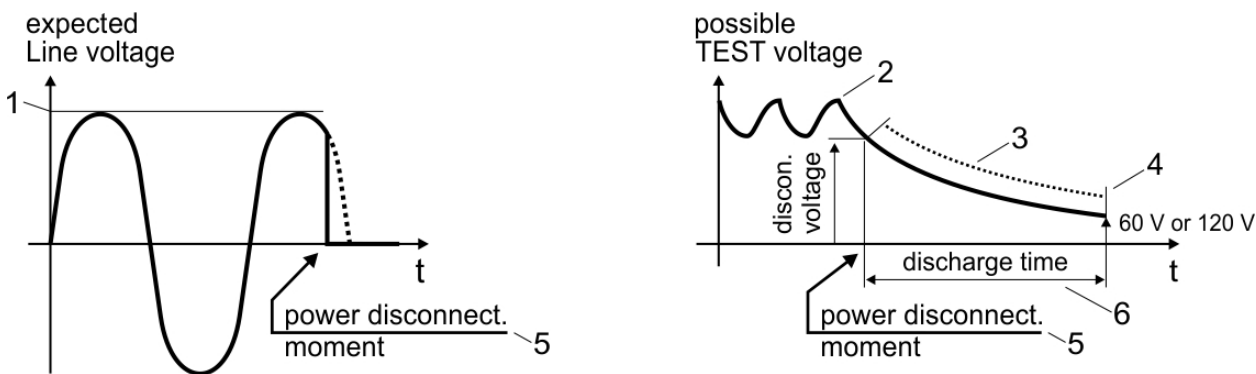

- (1) peak voltage
- (2) voltage at disconnection time
- (3) calculated voltage value
- (4) Ulim
- (5) moment of disconnection
- (6) discharging time

Figure 7.103: Discharging time measuring principle

Connection diagram

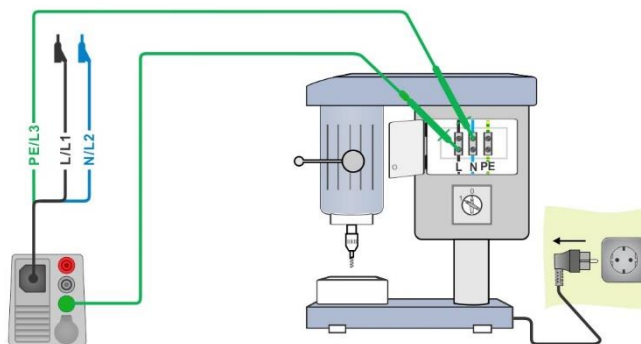

Figure 7.104: Discharging time measurement

Measurement procedure

- ▶ Enter the **Discharging time** function.
- ▶ Set test parameters / limits.
- ▶ Connect 3-wire test lead to the instrument and on the DUT, see **Figure 7.104**.
- ▶ Connect DUT to the mains supply and Switch it ON, see **Figure 7.104**.
- ▶ Start the measurement.
- ▶ Measurement will stop automatically when disconnecting DUT from mains supply.
- ▶ Save results (optional).



Figure 7.105: Discharging time results

### Measurement results / sub-results

<b>t</b>	Discharging time
<b>Up</b>	Peak value of voltage at disconnection time

## 7.31 AUTO TT – Auto test sequence for TT earthing system

Tests / measurements implemented in AUTO TT sequence

Voltage

Z line

Voltage Drop

Zs rcd

RCD Uc

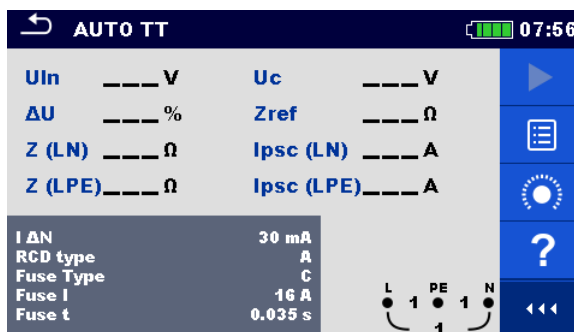

Figure 7.106: AUTO TT menu

### Measurement parameters / limits

<b>I ΔN</b>	<b>Rated RCD residual current sensitivity</b> [10 mA, 15 mA, 30 mA, 100 mA, 300 mA, 500 mA, 1000 mA]
<b>RCD type</b>	<b>RCD type</b> [AC, A, F, B, B+]
<b>Selectivity</b>	<b>Characteristic</b> [G, S]
<b>Fuse type</b>	<b>Selection of fuse type</b> [Off, gG, NV, B, C, D, K, Custom]
<b>Fuse I</b>	<b>Rated current of selected fuse</b>
<b>Fuse t</b>	<b>Maximum breaking time of selected fuse</b>
<b>I (ΔU)<sup>1)</sup></b>	<b>Rated current for ΔU measurement (custom value)</b>
<b>Isc factor</b>	<b>Isc factor</b> [0.20 ... 3.00]
<b>I test</b>	<b>Test current</b> [Standard, Low]
<b>Limit(ΔU)</b>	<b>Maximum voltage drop</b> [3.0 % ... 9.0 %]
<b>Limit Uc</b>	<b>Conventional touch voltage limit</b> [12 V, 25 V, 50 V]
<b>Ia(Ipsc (LN))</b>	<b>Minimum short circuit current for selected fuse or custom value</b>

<sup>1)</sup> Applicable if Fuse type is set to Off or Custom.

Refer to **Fuse tables guide** for detailed information on fuse data.

Connection diagram

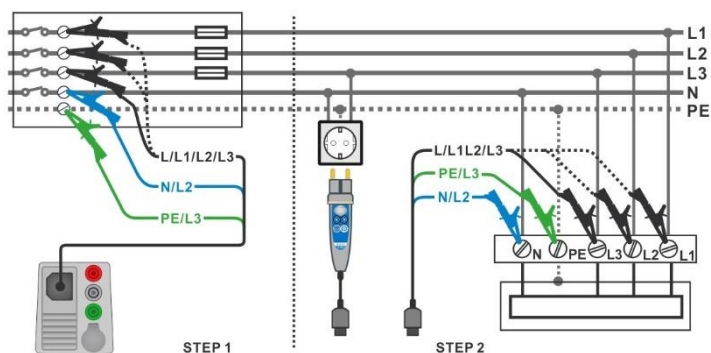

Figure 7.107: AUTO TT measurement

Measurement procedure

- ▶ Enter the **AUTO TT** function.
- ▶ Set test parameters / limits.
- ▶ Measure the impedance  $Z_{ref}$  at origin (optional), see chapter 7.18 Voltage Drop.
- ▶ Connect test cable to the instrument.
- ▶ Connect 3-wire test lead or Plug commander to the object under test, see Figure 7.107.
- ▶ Start the Auto test.
- ▶ Save results (optional).

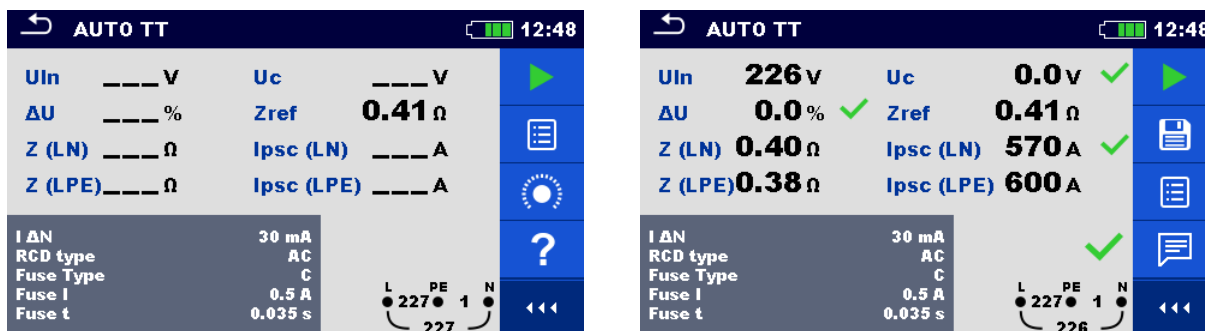

Figure 7.108: Examples of AUTO TT measurement results

Measurement results / sub-results

<b>U<sub>ln</sub></b>	Voltage between phase and neutral conductors
<b>ΔU</b>	Voltage drop
<b>Z (LN)</b>	Line impedance
<b>Z (LPE)</b>	Loop impedance
<b>U<sub>c</sub></b>	Contact voltage
<b>Z<sub>ref</sub></b>	Reference line impedance
<b>I<sub>pse</sub> (LN)</b>	Prospective short-circuit current
<b>I<sub>pse</sub> (LPE)</b>	Prospective fault current

## 7.32 AUTO TN (RCD) – Auto test sequence for TN earthing system with RCD

Tests / measurements implemented in AUTO TN (RCD) sequence

Voltage
Z line
Voltage Drop
Zs rcd
Rpe rcd

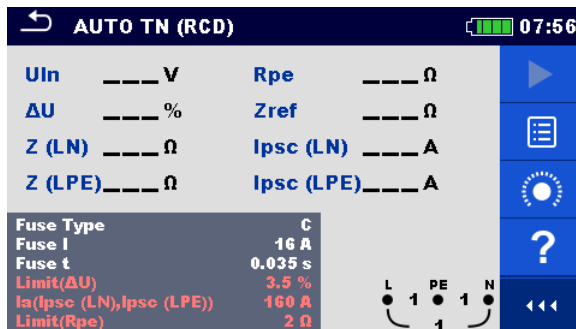

Figure 7.109: AUTO TN (RCD) menu

### Measurement parameters / limits

<b>Fuse type</b>	<b>Selection of fuse type</b> [Off, gG, NV, B, C, D, K, Custom]
<b>Fuse I</b>	<b>Rated current of selected fuse</b>
<b>Fuse t</b>	<b>Maximum breaking time of selected fuse</b>
<b>I (ΔU)<sup>1)</sup></b>	<b>Rated current for ΔU measurement (custom value)</b>
<b>Isc factor</b>	<b>Isc factor</b> [0.20 ... 3.00]
<b>I test</b>	<b>Test current</b> [Standard, Low]
<b>Limit(ΔU)</b>	<b>Maximum voltage drop</b> [3.0 % ... 9.0 %]
<b>Ia(Ipsc (LN), Ipsc (LPE))</b>	<b>Minimum short circuit current for selected fuse or custom value</b>
<b>Limit (Rpe)</b>	<b>Max. resistance</b> [Off, 0.1 Ω ... 20.0 Ω]

<sup>1)</sup> Applicable if Fuse type is set to Off or Custom.

Refer to **Fuse tables guide** for detailed information on fuse data.

### Connection diagram

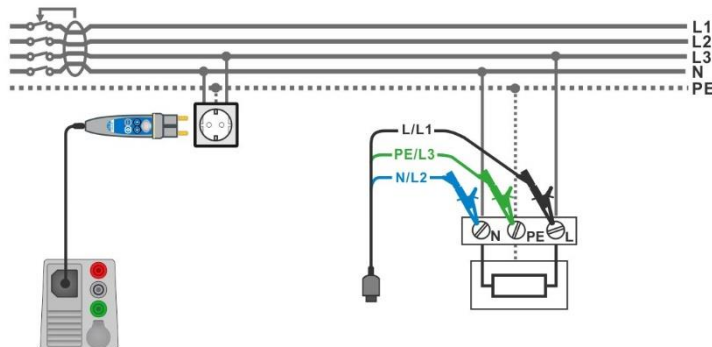

Figure 7.110: AUTO TN (RCD) measurement

## Measurement procedure

- › Enter the **AUTO TN (RCD)** function.
- › Set test parameters / limits.
- › Measure the impedance  $Z_{ref}$  at origin (optional), see chapter **7.18 Voltage Drop**.
- › Connect test cable to the instrument.
- › Connect 3-wire test lead or Plug commander to the object under test, see **Figure 7.110**.
- › Start the Auto test.
- › Save results (optional).



Figure 7.111: Examples of AUTO TN (RCD) measurement results

## Measurement results / sub-results

<b><math>U_{In}</math></b>	Voltage between phase and neutral conductors
<b><math>\Delta U</math></b>	Voltage drop
<b><math>Z (LN)</math></b>	Line impedance
<b><math>Z (LPE)</math></b>	Loop impedance
<b><math>R_{pe}</math></b>	PE conductor resistance
<b><math>Z_{ref}</math></b>	Reference Line impedance
<b><math>I_{psc} (LN)</math></b>	Prospective short-circuit current
<b><math>I_{psc} (LPE)</math></b>	Prospective fault current

### 7.33 AUTO TN – Auto test sequence for TN earthing system without RCD

Tests / measurements implemented in AUTO TN sequence

Voltage
Z line
Voltage Drop
Z loop
Rpe

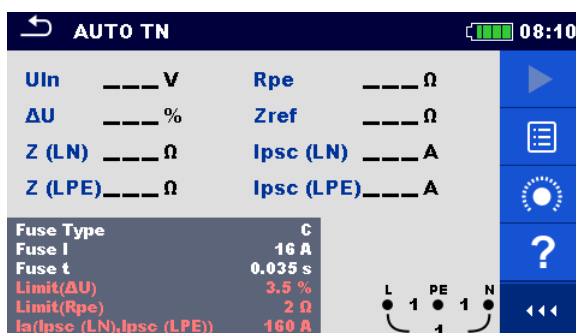

Figure 7.112: AUTO TN menu

#### Measurement parameters / limits

<b>Fuse type</b>	<b>Selection of fuse type</b> [Off, gG, NV, B, C, D, K, Custom]
<b>Fuse I</b>	<b>Rated current of selected fuse</b>
<b>Fuse t</b>	<b>Maximum breaking time of selected fuse</b>
<b>I (ΔU)<sup>1)</sup></b>	<b>Rated current for ΔU measurement (custom value)</b>
<b>Limit(ΔU)</b>	<b>Maximum voltage drop</b> [3.0 % ... 9.0 %]
<b>Limit(Rpe)</b>	<b>Max. resistance</b> [Off, 0.1 Ω ... 20.0 Ω]
<b>Ia(Ipsc (LN), Ipsc (LPE))</b>	<b>Minimum short circuit current for selected fuse or custom value</b>
<b>Isc factor</b>	<b>Isc factor</b> [0.20 ... 3.00]

<sup>1)</sup> Applicable if Fuse type is set to Off or Custom.

Refer to **Fuse tables guide** for detailed information on fuse data.

#### Connection diagram

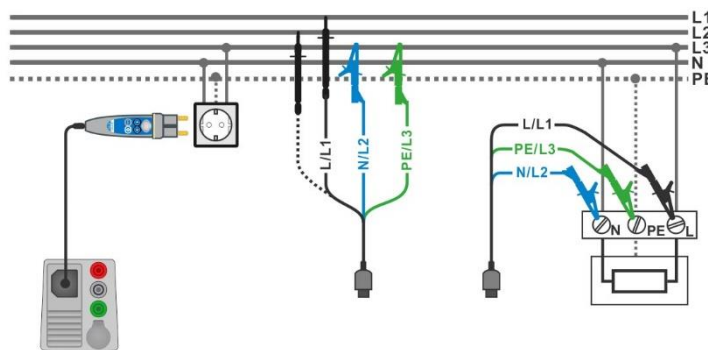

Figure 7.113: AUTO TN measurement



### Measurement procedure

- › Enter the **AUTO TN** function.
- › Set test parameters / limits.
- › Measure the impedance Zref at origin (optional), see chapter **7.18 Voltage Drop**.
- › Connect test cable to the instrument.
- › Connect 3-wire test lead or Plug commander to the object under test, see **Figure 7.113**.
- › Start the Auto test.
- › Save results (optional).

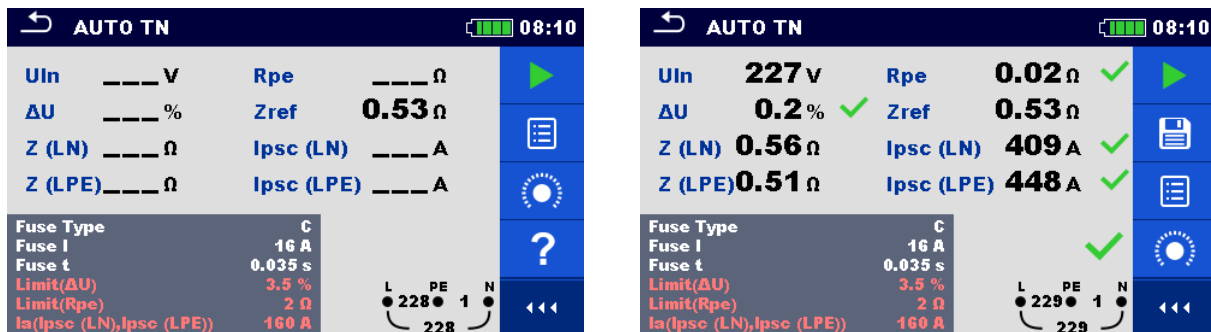

Figure 7.114: Examples of AUTO TN measurement results

### Measurement results / sub-results

<b>UIn</b>	Voltage between phase and neutral conductors
<b>ΔU</b>	Voltage drop
<b>Z (LN)</b>	Line impedance
<b>Z (LPE)</b>	Loop impedance
<b>Rpe</b>	PE conductor resistance
<b>Zref</b>	Reference Line impedance
<b>Ipsec (LN)</b>	Prospective short-circuit current
<b>Ipsec (LPE)</b>	Prospective fault current

## 7.34 AUTO IT – Auto test sequence for IT earthing system

Tests / measurements implemented in AUTO IT sequence

- \_\_\_\_\_ Voltage
- \_\_\_\_\_ Z line
- \_\_\_\_\_ Voltage Drop
- \_\_\_\_\_ ISFL
- \_\_\_\_\_ IMD

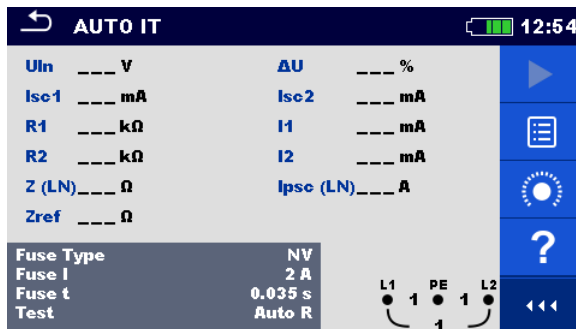

Figure 7.115: AUTO IT menu

Measurement parameters / limits

<b>Fuse type</b>	Selection of fuse type [Off, gG, NV, B, C, D, K, Custom]
<b>Fuse I</b>	Rated current of selected fuse
<b>Fuse t</b>	Maximum breaking time of selected fuse
<b>I (ΔU)<sup>1)</sup></b>	Rated current for ΔU measurement (custom value)
<b>Test</b>	Test mode [MANUAL R, MANUAL I, AUTO R, AUTO I]
<b>t step</b>	Timer (AUTO R and AUTO I test modes) [1 s ... 99 s]
<b>Isc factor</b>	Isc factor [0.20 ... 3.00]
<b>Limit(ΔU)</b>	Maximum voltage drop [3.0 % ... 9.0 %]
<b>Rmin(R1,R2)</b>	Min. insulation resistance [Off, 5 kΩ ... 640 kΩ],
<b>I<sub>max</sub>(I1,I2)</b>	Max. fault current [Off, 0.1 mA ... 19.9 mA]
<b>I<sub>max</sub>(Isc1,Isc2)</b>	Maximum first fault leakage current [Off, 3.0 mA ... 19.5 mA]
<b>I<sub>a</sub>(I<sub>psc</sub> (LN))</b>	Minimum short circuit current for selected fuse or custom value

<sup>1)</sup> Applicable if Fuse type is set to Off or Custom.

Refer to *Fuse tables guide* for detailed information on fuse data.

Connection diagram

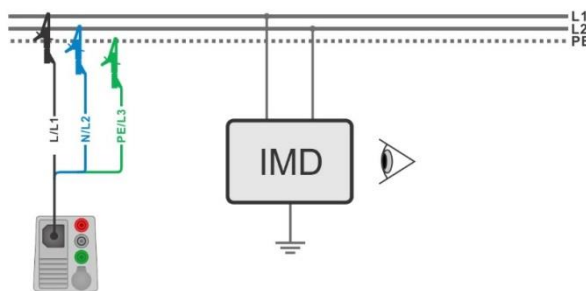

Figure 7.116: AUTO IT measurement

## Measurement procedure

- › Enter the **AUTO IT** function.
- › Set test parameters / limits.
- › Measure the impedance  $Z_{ref}$  at origin (optional), see chapter **7.18 Voltage Drop**.
- › Connect test cable to the instrument.
- › Connect 3-wire test lead to the object under test, see **Figure 7.116**.
- › Start the Auto test.
- › Save results (optional).

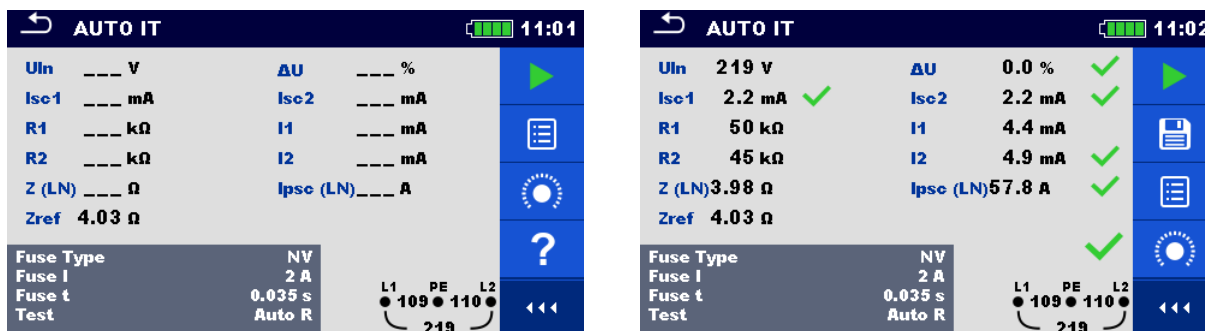

Figure 7.117: Examples of AUTO IT measurement results

## Measurement results / sub-results

<b>Uln</b>	Voltage between phases L1 and L2
<b><math>\Delta U</math></b>	Voltage drop
<b>Isc1</b>	First fault leakage current at single fault between L1/PE
<b>Isc2</b>	First fault leakage current at single fault between L2/PE
<b>R1</b>	Threshold insulation resistance between L1-PE
<b>R2</b>	Threshold insulation resistance between L2-PE
<b>I1</b>	Calculated first fault leakage current for R1
<b>I2</b>	Calculated first fault leakage current for R2
<b>Z (LN)</b>	Line impedance
<b>Zref</b>	Reference Line impedance
<b>Ipsc (LN)</b>	Prospective short-circuit current

## 7.35 Locator

This function is intended for tracing mains installation, like:

- Tracing lines,
- Finding shorts, breaks in lines,
- Detecting fuses.

The instrument generates test signals that can be traced with the handheld tracer receiver R10K. See **Appendix C – Locator receiver R10K** for additional information.

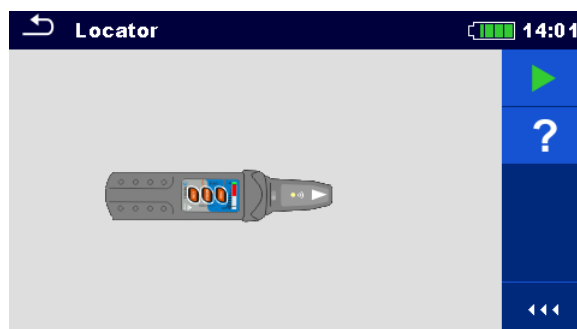

Figure 7.118: Locator main screen

### Typical applications for tracing electrical installation

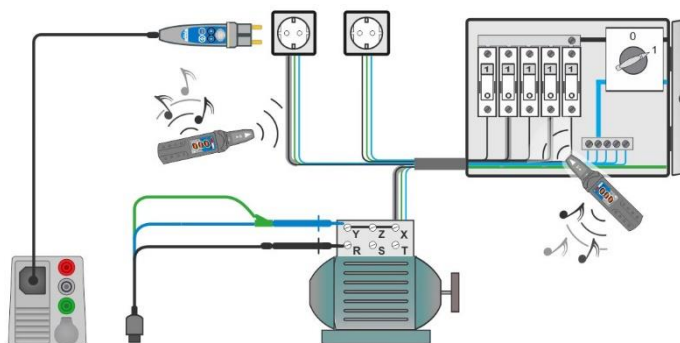

Figure 7.119: Tracing wires under walls and in cabinets

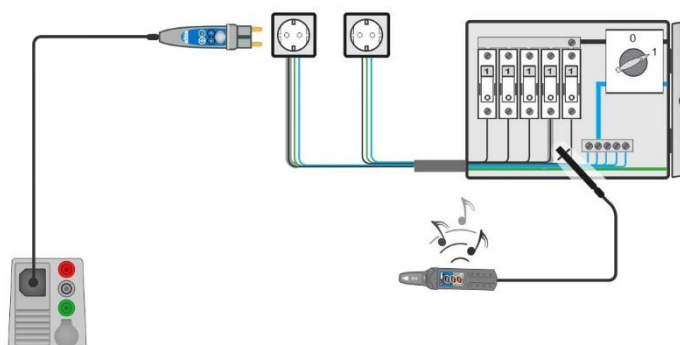

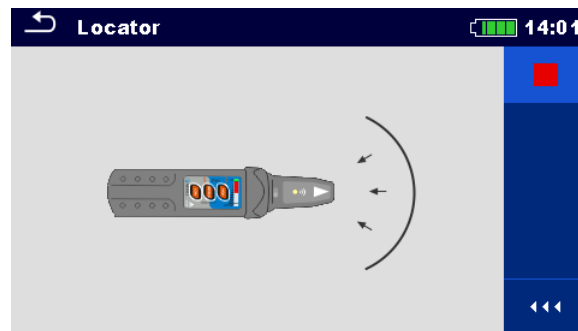

Figure 7.120: Locating individual fuses

**Line tracing procedure**

- › Select **Locator** function in **Other** menu.
- › Connect test cable to the instrument.
- › Connect 3-wire test lead or Plug commander to the tested object (see **Figure 7.119** and **Figure 7.120**).
- › Press the  key.
- › Trace lines with receiver (in IND mode) or receiver plus its optional accessory.
- › To stop tracing press the  key again.

**Figure 7.121: Locator active**

### 7.36 Visual and Functional inspections

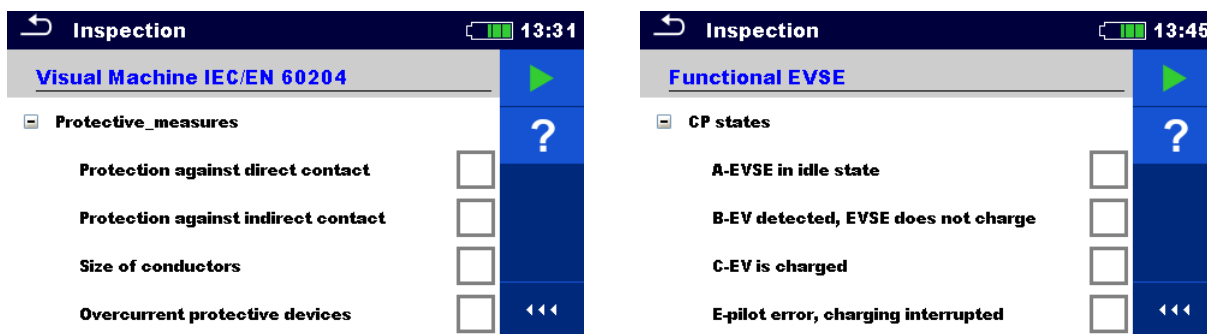

Figure 7.122: Examples of Visual / Functional inspection menu

#### Inspection

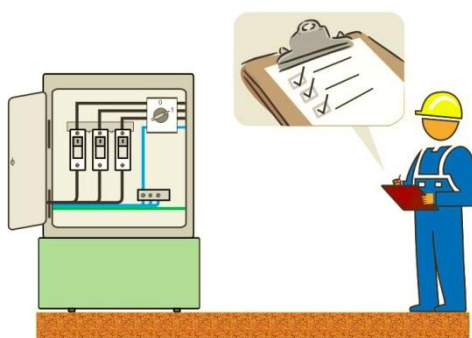

Figure 7.123: Visual / Functional inspection test circuit

#### Visual / Functional inspection procedure

- › Select the appropriate inspection test from **Visual** or **Function** menu.
- › Start the inspection.
- › Perform the inspection of the item under test.
- › Apply appropriate ticker(s) to items of inspection.
- › End inspection.
- › Save results (optional).

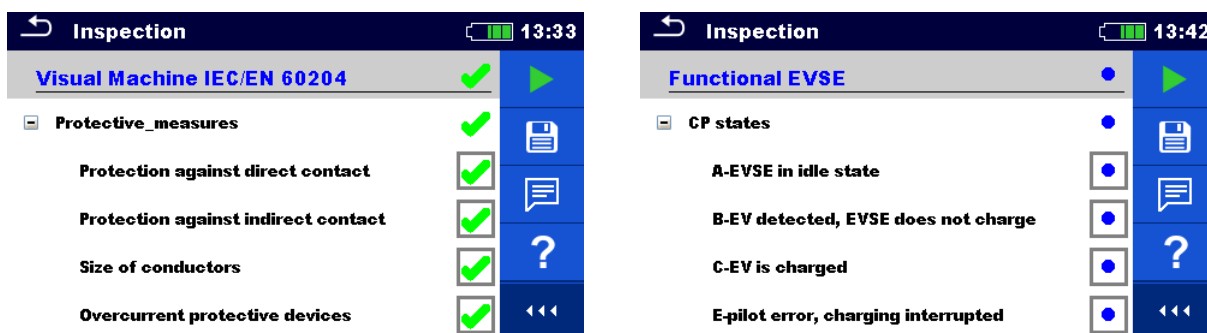

Figure 7.124: Examples of Visual / Functional inspection results

## 8 Auto Sequences®

Pre-programmed sequences of measurements can be carried out in Auto Sequences® menu. The sequence of measurements, their parameters and flow of the sequence can be programmed. The results of an Auto sequence® can be stored in the memory together with all related information.

Auto Sequences® can be pre-programmed on PC with the Metrel ES Manager software and uploaded to the instrument. Refer to chapter **Appendix F Programming of Auto Sequences® on Metrel ES Manager** for detailed information on programming Auto Sequences®.

On the instrument parameters and limits of individual single test in the Auto Sequence® can be changed / set.





### 8.1 Selection of Auto Sequences®

The Auto Sequence® list from Auto Sequence® groups menu should be selected first. Refer to chapter **4.9 Auto Sequence® groups** for more details.

#### 8.1.1 Selecting an active Auto Sequence® group in Auto Sequences® menu

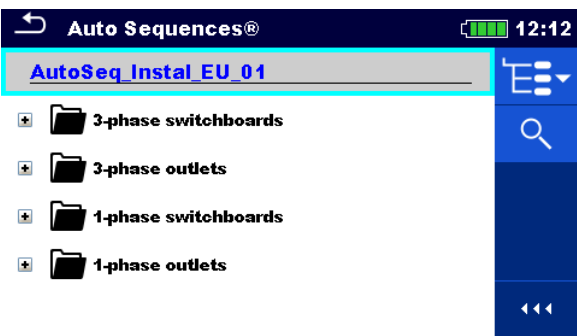
Auto Sequences® and Auto Sequence® group menus are interconnected so an active Auto Sequence® group can be selected also in the Auto Sequences® menu.

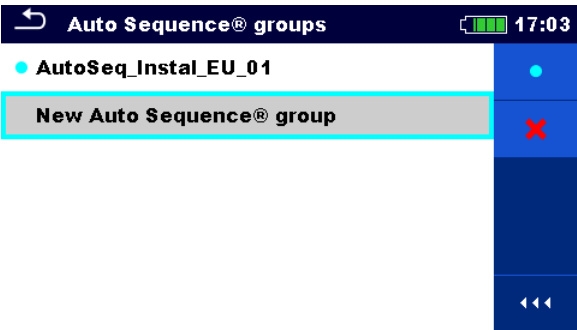
##### Procedure

- |   |   |  |
|---|---|--|
| ① |  | Tap on the active Auto Sequence® group header in Auto Sequences® Menu. |
| ② |  | Opens a list of Auto Sequence® groups in Control panel.                |
| ③ |  | Selects desired Auto Sequence® group from a list of groups.            |
| ④ |  | Confirms a new selection.  |

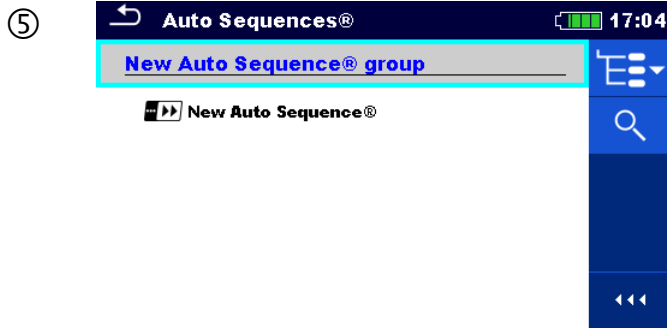

New Auto Sequence® group is selected and all Auto Sequences® within that group are displayed on the screen.

### 8.1.2 Searching in Auto Sequences® menu

In Auto Sequence® menu it is possible to search for Auto Sequences® on base of their Name or Short code.

#### Procedure

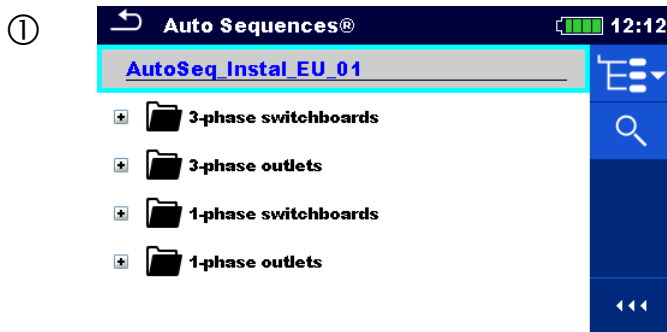

Search function is available from the active Auto Sequence® group header line.



Select Search in control panel to open Search setup menu.

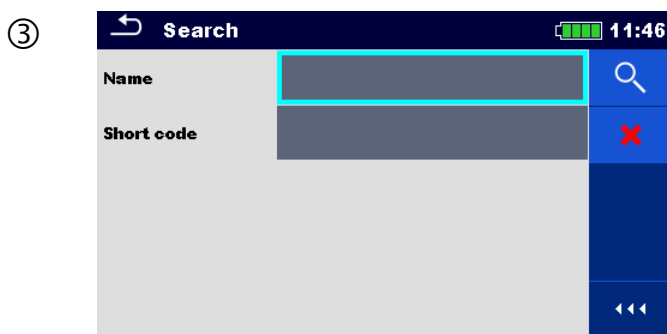

The parameters that can be searched for are displayed in the Search setup menu.



The parameters that can be searched for are displayed in the Search setup menu.

The search can be narrowed by entering a text in the Name and Short code fields.



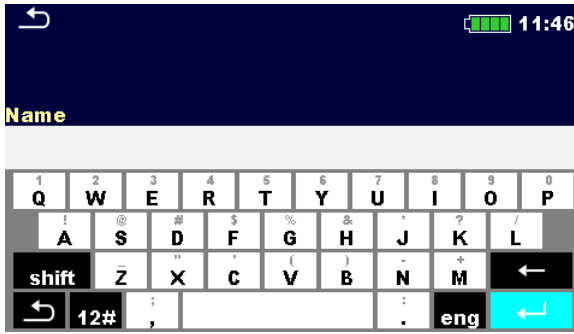

Strings can be entered by using the on-screen keyboard.



Clears all filters. Sets filters to default value.



Searches through the active Auto Sequence® group according to the set filters.

The results are shown in the Search results screen presented on **Figure 8.1**.

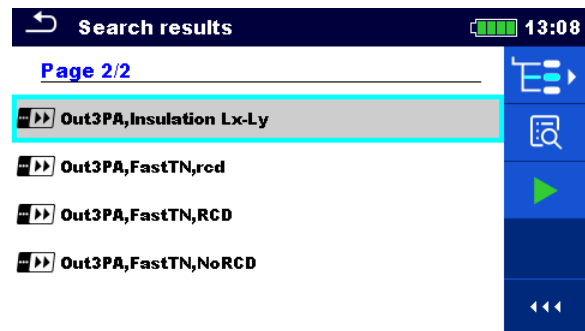
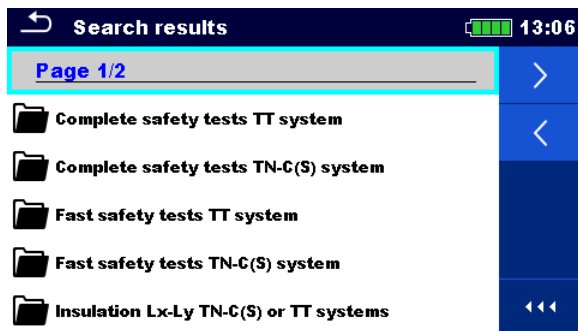

Figure 8.1: Search results screen (left), Auto Sequence selected (right)

**Options**



Next page.



Previous page.



Goes to location in Auto Sequences® menu.



Goes to Auto Sequence® view menu.



Starts the selected Auto Sequence®.

**Note:**

- › Search result page consist of up to 50 results.

### 8.1.3 Organization of Auto Sequences® in Auto Sequences® menu

The Auto Sequences® to be carried out can be selected from the Main Auto Sequences® menu. This menu can be organized in a structural manner with folders, sub-folders and Auto Sequences®. Auto Sequence® in the structure can be the original Auto Sequence® or a shortcut to the original Auto Sequence®.

Auto Sequences® marked as shortcuts and the original auto Sequences® are coupled. Changing of parameters or limits in any of the coupled Auto Sequences® will influence on the original Auto Sequence® and all its shortcuts.

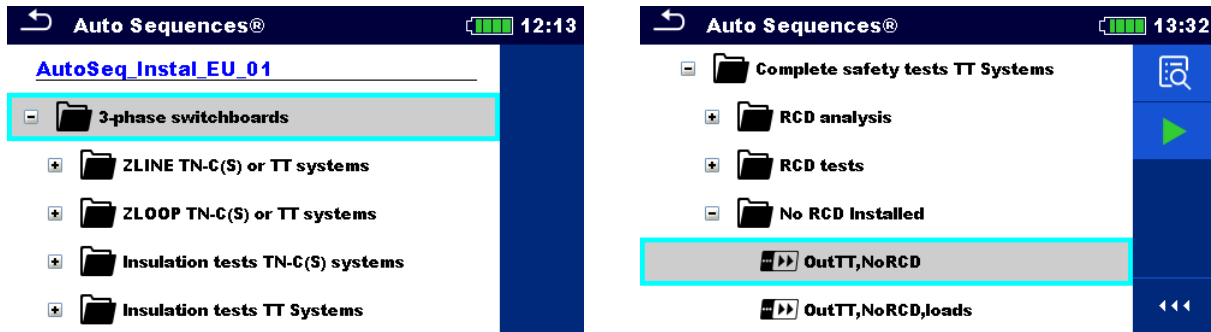







Figure 8.2: Examples of organized Auto Sequences® in main Auto Sequences® menu

#### Options

	<b>Auto Sequence®</b> The original Auto Sequence®.
	<b>Auto Sequence®</b> A shortcut to the original Auto Sequence®.
	Enters menu for more detail view of selected Auto sequence®. This option should also be used if the parameters / limits of the selected Auto Sequence® have to be changed. Refer to chapter <b>8.2.1 Auto Sequence® view menu</b> for more information.
	Starts the selected Auto Sequence®. The instrument immediately starts the Auto sequence®.
	Searches within the Auto Sequences® menu. Refer to chapter <b>8.1.2 Searching in Auto Sequences® menu</b> for more information.

## 8.2 Organization of an Auto Sequence®

An Auto Sequence® is divided into three phases:

- Before starting the first test the Auto Sequence® view menu is shown (unless it was started directly from the Main Auto Sequences® menu). Parameters and limits of individual measurements can be set in this menu.

- › During the execution phase of an Auto Sequence®, pre-programmed single tests are carried out. The sequence of single tests is controlled by pre-programmed flow commands.
- › After the test sequence is finished the Auto Sequence® result menu is shown. Details of individual tests can be viewed and the results can be saved to Memory organizer.

## 8.2.1 Auto Sequence® view menu

In the Auto Sequence® view menu, the header and the single tests of selected Auto Sequence® are displayed. The header contains Name, Short code and description of the Auto Sequence®. Before starting the Auto Sequence®, test parameters / limits of individual measurements can be changed.

### Note:

- › Once fuse and RCD parameters are changed in active Auto Sequence®, the new settings are distributed through all single tests within the active Auto Sequence® and stored for next use of the same Auto Sequence®.

### 8.2.1.1 Auto Sequence® view menu (Header is selected)

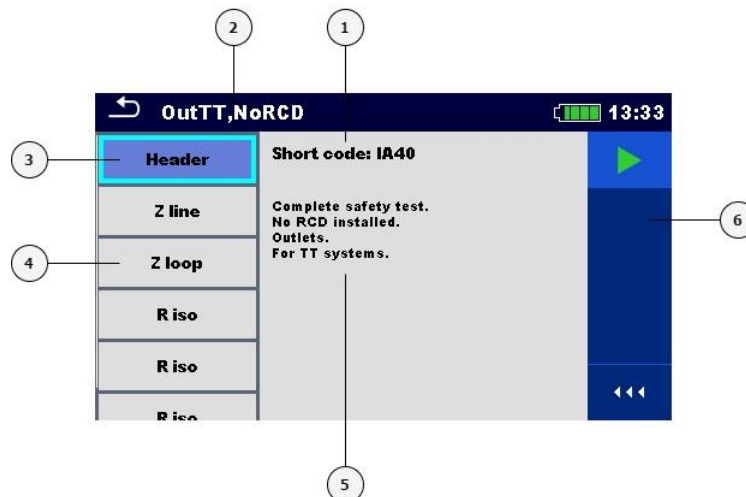

Figure 8.3: Screen organization in Auto Sequence® view menu – Header selected

### Legend

- 1 Short code
- 2 Auto Sequence® name
- 3 Header
- 4 Single tests
- 5 Description
- 6 Control panel (available options)

### Option



Starts the Auto Sequence®.

### 8.2.1.2 Auto Sequence® view menu (measurement is selected)

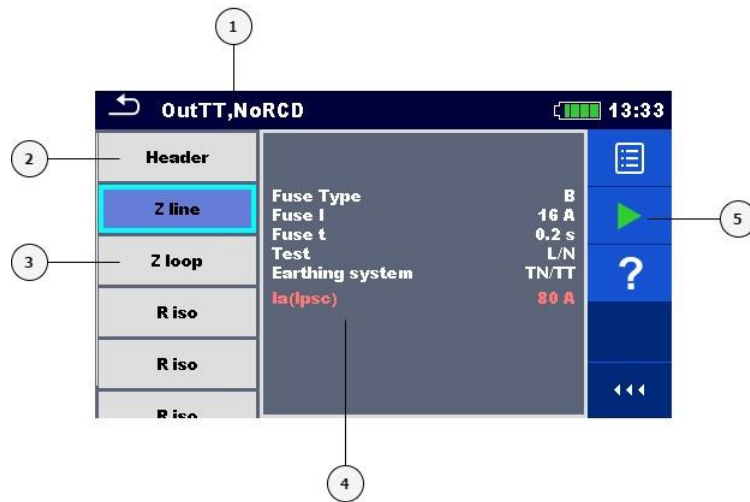

Figure 8.4: Screen organization in Auto Sequence® view menu – measurement selected

#### Legend

- 1 Auto Sequence® name
- 2 Header
- 3 Single tests
- 4 Parameters / limits of selected single test
- 5 Control panel (available options)

#### Options



Selects single test.



Opens menu for changing parameters and limits of selected measurements.

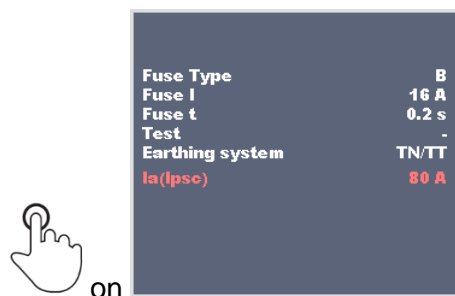

Refer to chapter **6.1.2 Setting parameters and limits of single tests** for more information how to change measurement parameters and limits.

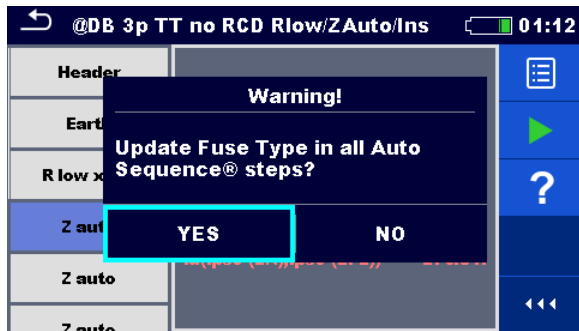

User must decide whether the changes in global parameter(s) apply to all single tests within the selected Auto Sequence® containing the modified parameter(s), or only for the edited one.



Starts the Auto Sequence®.



Opens help screens. Refer to chapter **6.1.8 Help screens** for more information.

### 8.2.1.3 Indication of Loops

R iso x3

The attached 'x3' at the end of a single test name indicates that a loop of single tests is programmed. This means that the marked single test will be carried out as many times as the number behind the 'x' indicates. It is possible to exit the loop before, at the end of each individual measurement.

## 8.2.2 Step by step execution of Auto Sequences®

While the Auto Sequence® is running, it is controlled by pre-programmed flow commands. Examples of actions controlled by flow commands are:

- pauses during the Auto Sequence®,
- buzzer/ PASS/FAIL sound after the tests,
- proceeding of test sequence in regard to measured results,
- etc.

The actual list of flow commands is available on chapter **F.7 – Description of flow commands**.

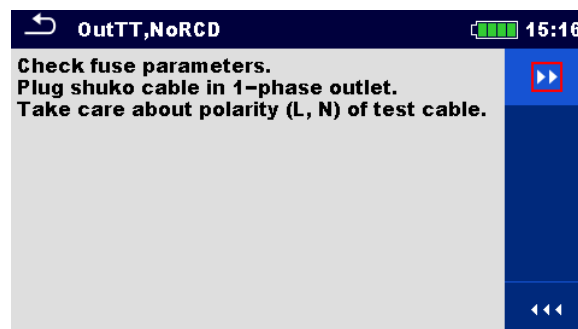

Figure 8.5: Auto Sequence® – Example of a pause with message

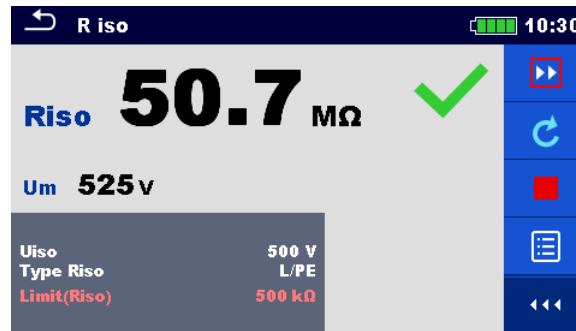

Figure 8.6: Auto Sequence® – Example of a finished measurement with options for proceeding

#### Options (during execution of an Auto Sequence®):



Proceeds to the next step in the test sequence.



Repeats the measurement.

Displayed result of a single test will not be stored.



Ends the Auto Sequence® and goes to Auto Sequence® result screen.

Refer to chapter **8.2.3 Auto Sequence® result screen** for more information.



Exits the loop of single tests and proceeds to the next step in the Auto Sequence®.

The offered options in the control panel depend on the selected single test, its result and the programmed test flow.

#### Notes:

- During Auto Sequences® the popup Warning messages are displayed only before the single test inside one Auto Sequence®. This default setting can be changed with appropriate flow command. For more information about programming Auto Sequences® refer to chapter **Appendix F – Programming of Auto Sequences® on Metrel ES Manager**.

### 8.2.3 Auto Sequence® result screen

After the Auto Sequence® is finished the Auto Sequence® result screen is displayed. On the left side of the display the single tests and their statuses in the Auto Sequence® are shown.

In the middle of the display the header of the Auto Sequence® with Short code and description of the Auto Sequence® is displayed. At the top the overall Auto Sequence® result status is displayed. Refer to chapter **5.1.1 Measurement statuses** for more information.

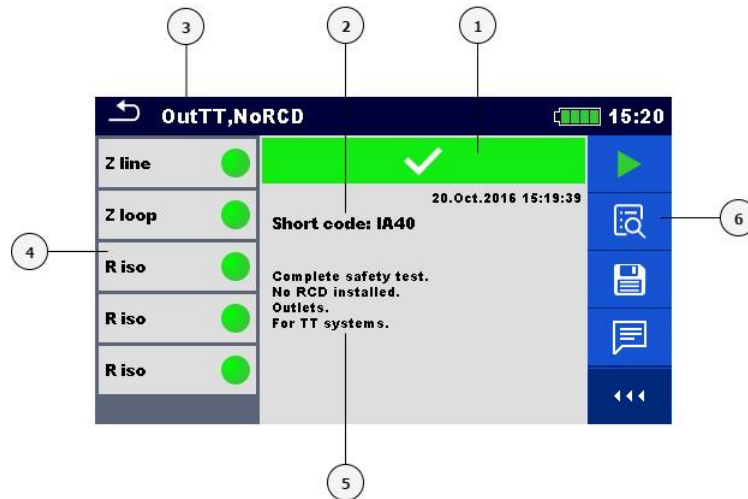

Figure 8.7: Auto Sequence® result screen

#### Legend

- 1 Overall PASS / FAIL status
- 2 Short code
- 3 Auto Sequence® name
- 4 Single tests with individual PASS / FAIL statuses
- 5 Description
- 6 Control panel (available options)

#### Options



Starts a new Auto Sequence®.



View results of individual measurements.

The instrument goes to the menu for viewing details of the Auto Sequence®.



Saves the Auto Sequence® results.

A new Auto Sequence® was selected and started from a Structure object in the structure tree:

- The Auto Sequence® result will be saved under the selected Structure object.

A new Auto Sequence® was started from the Auto Sequence® main menu:

- Saving under the last selected Structure object will be offered by default. The user can select another Structure object or create a new Structure object. By pressing  in Memory organizer menu the Auto Sequence result is saved under selected location.

An empty measurement was selected in structure tree and started:

- The result(s) will be added to the Auto Sequence®. The Auto Sequence® will change its overall status from 'empty' to 'finished'.

An already carried out Auto Sequence® was selected in structure tree, viewed and then restarted:

- A new Auto Sequence® result will be saved under the selected Structure object.



Adds comment to the Auto Sequence®. The instrument opens keypad for entering a comment.

### Options (menu for viewing details of Auto Sequence® and single test results)



Details of a selected single test in Auto Sequence® are displayed.



View parameters and limits of selected single test.



Adds comment to the selected single test in Auto Sequence®. The instrument opens keypad for entering a comment.

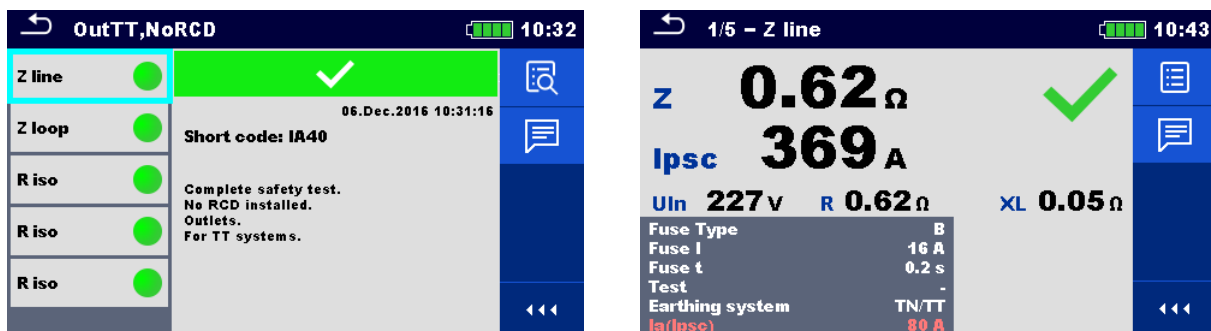

Figure 8.8: Details of menu for viewing details of Auto Sequence® results

## 8.2.4 Auto Sequence® memory screen

In Auto Sequence® memory screen details of the Auto Sequence® results can be viewed and a new Auto Sequence® can be restarted.



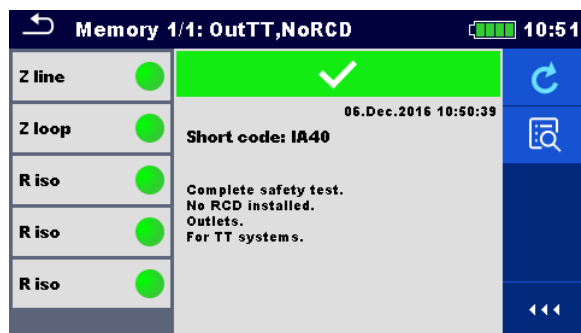

Figure 8.9: Auto Sequence® memory screen

## Options



Retest the Auto Sequence®.

Enters menu for a new Auto Sequence®.



Enters menu for viewing details of the Auto Sequence®. Refer to chapter **8.2.3 Auto Sequence® result screen** for more information.

## 9 Communication

The instrument can communicate with the Metrel ES Manager PC software. The following action is supported:

- › Saved results and Tree structure from Memory organizer can be downloaded and stored to a PC.
- › Tree structure from Metrel ES Manager PC software can be uploaded to the instrument.
- › Custom Auto Sequences® can be uploaded to the instrument or downloaded and stored to a PC.

Metrel ES Manager is a PC software running on Windows 7, Windows 8, Windows 8.1 and Windows 10.

There are three communication interfaces available on the instrument: RS-232, USB and Bluetooth. Instrument can also communicate to various external devices (android devices, test adapters, scanners ...).

### 9.1 USB and RS232 communication

The instrument automatically selects the communication mode according to detected interface. USB interface has priority.

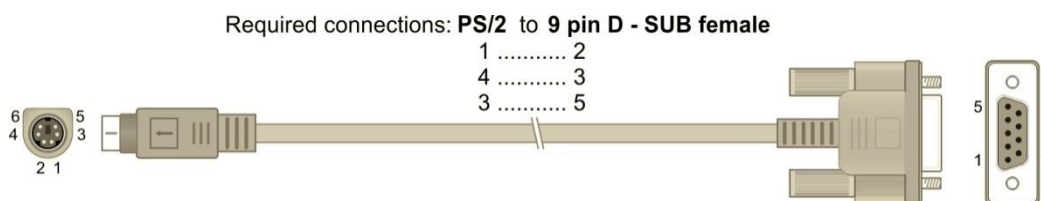

**Figure 9.1: Interface connection for data transfer over PC COM port**

#### How to establish an USB or RS-232 link

- › RS-232 communication: connect a PC COM port to the instrument PS/2 connector using the PS/2 - RS232 serial communication cable;
- › USB communication: connect a PC USB port to the instrument USB connector using the USB interface cable.
- › Switch on the PC and the instrument.
- › Run the *Metrel ES Manager* software.
- › Select communication port (COM port for USB communication is identified as 'Measurement Instrument USB VCom Port'.
- › The instrument is prepared to communicate with the PC.

### 9.2 Bluetooth communication

The internal Bluetooth module enables easy communication via Bluetooth with PC and Android devices.

#### How to configure a Bluetooth link between instrument and PC

- › Switch on the instrument.
- › On PC configure a Standard Serial Port to enable communication over Bluetooth link between instrument and PC. Usually no code for pairing the devices is needed.
- › Run the *Metrel ES Manager* software.
- › Select configured communication port.

- 
- › The instrument is prepared to communicate with the PC.
- 

### **How to configure a Bluetooth link between instrument and an Android device**

- 
- › Switch on the instrument.
  - › Some Android applications automatically carry out the setup of a Bluetooth connection. It is preferred to use this option if it exists. This option is supported by Metrel's Android applications.  
If this option is not supported by the selected Android application then configure a Bluetooth link via Android device's Bluetooth configuration tool. Usually no code for pairing the devices is needed.
  - › The instrument and Android device are ready to communicate.
- 

#### **Notes**

- › Sometimes there will be a demand from the PC or Android device to enter the code. Enter code '1234' to correctly configure the Bluetooth link.
- › The name of correctly configured Bluetooth device must consist of the instrument type plus serial number, e.g. *MI 3155-12240429I*. If the Bluetooth module got another name, the configuration must be repeated.
- › In case of serious troubles with the Bluetooth communication it is possible to reinitialize the internal Bluetooth module. The initialization is carried out during the Initial settings procedure. In case of a successful initialization "INITIALIZING... OK!" is displayed at the end of the procedure. See chapter **4.6.10 Initial Settings**.
- › Check if Metrel Android applications are available for this instrument.

## **9.3 Bluetooth and RS-232 communication with scanners**

EurotestXD instrument can communicate with supported Bluetooth and serial scanners. Serial scanner should be connected to the instrument via PS/2 serial port. Contact Metrel or your distributor which external devices and functionalities are supported. See chapter **4.6.9 Devices** for details how to set the external Bluetooth or serial device.

## 10 Upgrading the instrument

The instrument can be upgraded from a PC via the RS232 or USB communication port. This enables to keep the instrument up to date even if the standards or regulations change. The firmware upgrade requires internet access and can be carried out from the **Metrel ES Manager** software with a help of special upgrading software – **FlashMe** which will guide you through the upgrading procedure. For more information refer to Metrel ES Manager Help file.

# 11 Maintenance

Unauthorized persons are not allowed to open the EurotestXD instrument. There are no user replaceable components inside the instrument, except the battery and fuses under back cover.

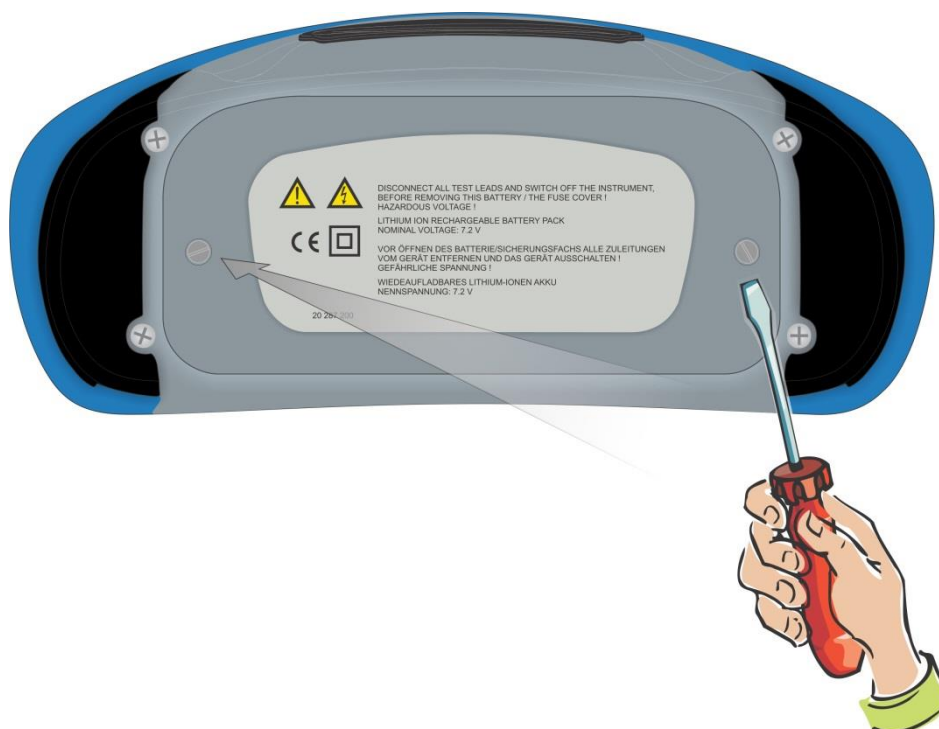

Figure 11.1: Position of screws to open battery / fuse compartment

## 11.1 Fuse replacement

There are three fuses under back cover of the EurotestXD instrument.

---

**F1** M 0.315 A / 250 V, 20×5 mm

This fuse protects internal circuitry for continuity functions if test probes are connected to the mains supply voltage by mistake during measurement.

---

**F2, F3** F 5 A / 500 V, 32×6.3 mm (breaking capacity: 50 kA)

General input protection fuses of test terminals L/L1 and N/L2.

---

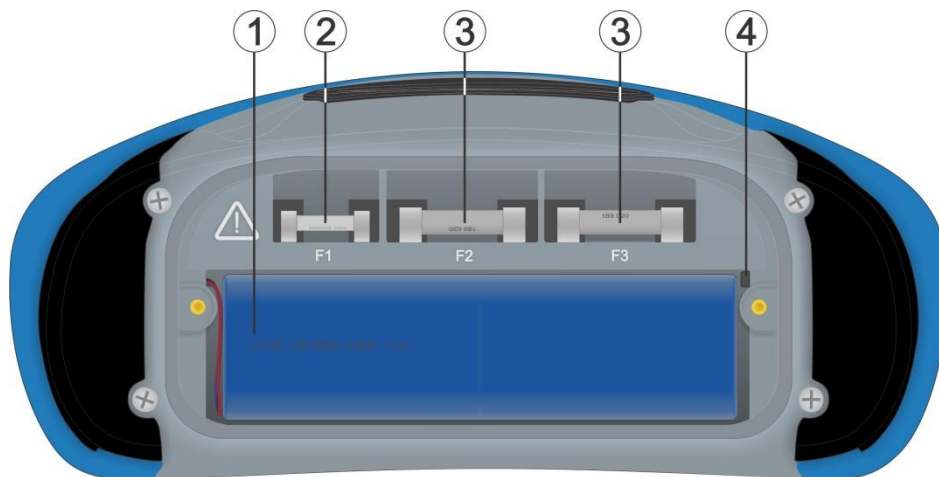

Figure 11.2: Fuses

**Warnings:**

- Disconnect all measuring accessory and switch off the instrument before opening battery / fuse compartment cover, hazardous voltage inside!
- Replace blown fuse with original type only, otherwise the instrument or accessory may be damaged and / or operator’s safety impaired!

## 11.2 Battery pack insertion / replacement

**Procedure:**

<p>①</p>	<p>Remove the battery pack from battery compartment.</p>	
<p>②</p>	<p>Remove foam if were inserted under the battery pack.</p>	
<p>③</p>	<p>Press to unlock the connector (1) and pull the wires (2) to disconnect the battery pack from the instrument.</p>	
<p>①</p>	<p>Connect the new battery pack to the instrument.</p>	
<p>②</p>	<p>For standard capacity pack use a foam (2) to fill empty space.</p>	
<p>③</p>	<p>Insert the battery pack in battery compartment and close the battery / fuse compartment cover. <b>Note:</b></p>	

	When placing high-capacity battery pack make sure that protection circuit module of the battery pack is placed at top inner side of the compartment.	
--	--	--

**Warnings:**

- › Disconnect all measuring accessory and switch off the instrument before opening battery / fuse compartment cover, hazardous voltage inside!
- › Replace battery pack with original type only, otherwise the instrument may be damaged and / or operator's safety impaired!
- › Ensure batteries are used and disposed of in accordance with Manufacturers guidelines and in accordance with Local and National Authority guidelines.

### 11.3 Cleaning

No special maintenance is required for the housing. To clean the surface of the instrument or accessory use a soft cloth slightly moistened with soapy water or alcohol. Then leave the instrument or accessory to dry totally before use.

**Warnings:**

- › Do not use liquids based on petrol or hydrocarbons!
- › Do not spill cleaning liquid over the instrument!

### 11.4 Periodic calibration

It is essential that the test instrument is regularly calibrated in order that the technical specification listed in this manual is guaranteed. We recommend an annual calibration. Only an authorized technical person can do the calibration. Please contact your dealer for further information.

### 11.5 Service

For repairs under warranty, or at any other time, please contact your distributor.

## 12 Technical specifications

### 12.1 R iso, R iso all – Insulation resistance

**Uiso: 50 V, 100 V and 250 V (R iso, R iso all)**

**Riso – Insulation resistance (R iso)**

**R L-N, R L-PE, R N-PE – Insulation resistance (R iso all)**

Measuring range according to EN 61557 is 0.15 M $\Omega$  ... 199.9 M $\Omega$ .

Measuring range (M $\Omega$ )	Resolution (M $\Omega$ )	Accuracy
0.00 ... 19.99	0.01	$\pm(5\%$ of reading + 3 digits)
20.0 ... 99.9	0.1	$\pm(10\%$ of reading)
100.0 ... 199.9		$\pm(20\%$ of reading)

**Uiso: 500 V and 1000 V (R iso, R iso all)**

**Riso – Insulation resistance (R iso)**

**R L-N, R L-PE, R N-PE – Insulation resistance (R iso all)**

Measuring range according to EN 61557 is 0.15 M $\Omega$  ... 999 M $\Omega$ .

Measuring range (M $\Omega$ )	Resolution (M $\Omega$ )	Accuracy
0.00 ... 19.99	0.01	$\pm(5\%$ of reading + 3 digits)
20.0 ... 199.9	0.1	$\pm(5\%$ of reading)
200 ... 999	1	$\pm(10\%$ of reading)

**Uiso: 2500V (R iso)**

**Riso – Insulation resistance**

Measuring range ( $\Omega$ )	Resolution ( $\Omega$ )	Accuracy
0.00 M ... 19.99 M	0.01 M	$\pm(5\%$ of reading + 3 digits)
20.0 M ... 199.9 M	0.1 M	$\pm(5\%$ of reading)
200 M ... 999 M	1 M	$\pm(10\%$ of reading)
1.00 G ... 19.99 G	0.01 G	$\pm(10\%$ of reading)

**Um – Voltage (Riso, Riso all)**

Measuring range (V)	Resolution (V)	Accuracy
0 ... 2700	1	$\pm(3\%$ of reading + 3 digits)

Nominal voltages Uiso ..... 50 V<sub>DC</sub>, 100 V<sub>DC</sub>, 250 V<sub>DC</sub>, 500 V<sub>DC</sub>, 1000 V<sub>DC</sub>,  
2500 V<sub>DC</sub>

Open circuit voltage ..... -0 % / +20 % of nominal voltage

Measuring current ..... min. 1 mA at  $R_N = U_N \times 1 \text{ k}\Omega/\text{V}$

Short circuit current ..... max. 3 mA

The number of possible tests

(R iso, Riso all) ..... up to 1000, with a fully charged battery (type:  
18650T22A2S2P)  
up to 2000, with a fully charged battery (type:  
18650T22A2S4P)

Auto discharge after test.

Specified accuracy is valid if 3-wire test lead is used while it is valid up to 100 M $\Omega$  if Tip commander is used.

Specified accuracy is valid up to 100 M $\Omega$  if relative humidity is > 85 %.



In case the instrument gets moistened, the results could be impaired. In such case, it is recommended to dry the instrument and accessories for at least 24 hours.  
The error in operating conditions could be at most the error for reference conditions (specified in the manual for each function)  $\pm 5\%$  of measured value.

## 12.2 Diagnostic test

Uiso: 500V, 1000 V, 2500 V

### DAR – Dielectric absorption ratio

Measuring range	Resolution	Accuracy
0.01 ... 9.99	0.01	$\pm(5\%$ of reading + 2 digits)
10.0 ... 100.0	0.1	$\pm(5\%$ of reading)

### PI – Polarization index

Measuring range	Resolution	Accuracy
0.01 ... 9.99	0.01	$\pm(5\%$ of reading + 2 digits)
10.0 ... 100.0	0.1	$\pm(5\%$ of reading)

For **Riso**, **R60** and **Um** sub-results technical specifications defined in chapter **12.1 R iso, R iso all – Insulation resistance** apply.

## 12.3 R low, R low 4W – Resistance of earth connection and equipotential bonding

Measuring range according to EN 61557 is 0.16  $\Omega$  ... 1999  $\Omega$ .

### R – Resistance

Measuring range ( $\Omega$ )	Resolution ( $\Omega$ )	Accuracy
0.00 ... 19.99	0.01	$\pm(3\%$ of reading + 3 digits)
20.0 ... 199.9	0.1	$\pm(5\%$ of reading)
200 ... 1999	1	

### R+, R – Resistance

Measuring range ( $\Omega$ )	Resolution ( $\Omega$ )	Accuracy
0.0 ... 199.9	0.1	$\pm(5\%$ of reading + 5 digits)
200 ... 1999	1	

Open-circuit voltage.....6.5 VDC ... 18 VDC  
 Measuring current.....min. 200 mA into load resistance of 2  $\Omega$   
 Test lead compensation (Rlow) .....up to 5  $\Omega$   
 The number of possible tests  
 (Rlow, Rlow 4W).....up to 1700, with a fully charged battery (type: 18650T22A2S2P)  
 up to 3400, with a fully charged battery (type: 18650T22A2S4P)

Automatic polarity reversal of the test voltage.

## 12.4 Continuity – Continuous resistance measurement with low current

### R – Continuity resistance

Measuring range (Ω)	Resolution (Ω)	Accuracy
0.0 ... 19.9	0.1	±(5 % of reading + 3 digits)
20 ... 1999	1	

Open-circuit voltage.....6.5 VDC ... 18 VDC

Short-circuit current .....max. 8.5 mA

Test lead compensation.....up to 5 Ω

## 12.5 RCD testing

### 12.5.1 General data

Nominal residual current (A,AC) ..... 10 mA, 15 mA, 30 mA, 100 mA, 300 mA, 500 mA, 1000 mA

Nominal residual current accuracy.....-0 / +0.1·I<sub>Δ</sub>; I<sub>Δ</sub> = I<sub>ΔN</sub>, 2×I<sub>ΔN</sub>, 5×I<sub>ΔN</sub>

-0.1·I<sub>Δ</sub> / +0; I<sub>Δ</sub> = 0.5×I<sub>ΔN</sub>

AS/NZS 3017 selected: ± 5 %

Test current shape.....Sine-wave (AC), pulsed (A, F), smooth DC (B, B+)

DC offset for pulsed test current .....< 2 mA (typical)

RCD type.....(non-delayed), S (time-delayed), PRCD, PRCD-K, PRCD-S, EV/MI RCD

Test current starting polarity ..... 0° or 180°

Voltage range .....93 V ... 134 V (16 Hz ... 400 Hz)

185 V ... 266 V (16 Hz ... 400 Hz)

#### RCD test current in relation to RCD type, nominal RCD current and multiplication factor

I <sub>ΔN</sub> (mA)	I <sub>ΔN</sub> × 1/2 (mA)			I <sub>ΔN</sub> × 1 (mA)			I <sub>ΔN</sub> × 2 (mA)			I <sub>ΔN</sub> × 5 (mA)			RCD I <sub>Δ</sub>		
	AC	A, F	B, B+	AC	A, F	B, B+	AC	A, F	B, B+	AC	A, F	B, B+	AC	A, F	B, B+
10	5	3.5	5	10	20	20	20	40	40	50	100	100	✓	✓	✓
15	7.5	5.3	7.5	15	30	30	30	60	60	75	150	150	✓	✓	✓
30	15	10.5	15	30	42	60	60	84	120	150	212	300	✓	✓	✓
100	50	35	50	100	141	200	200	282	400	500	707	1000	✓	✓	✓
300	150	105	150	300	424	600	600	848	×	1500	×	×	✓	✓	✓
500	250	175	250	500	707	1000	1000	1410	×	2500	×	×	✓	✓	✓
1000	500	350	500	1000	1410	×	2000	×	×	×	×	×	✓	✓	×

× .....not applicable

✓ .....applicable

AC type.....sine wave test current

A, F types.....pulsed current

B, B+ types.....smooth DC current

**RCD test current in relation to MI / EV RCD type and multiplication factor**

$I_{\Delta N}$ (mA)	$I_{\Delta N} \times 1/2$ (mA)	$I_{\Delta N} \times 1$ (mA)	$I_{\Delta N} \times 2$ (mA)	$I_{\Delta N} \times 5$ (mA)	RCD $I_{\Delta}$	
	MI / EV a.c.	MI / EV a.c.	MI / EV a.c.	MI / EV a.c.	MI / EV a.c.	MI / EV d.c.
30 a.c.	15	30	60	150	✓	×
6 d.c.	×	×	×	×	×	✓

× .....not applicable

✓ .....applicable

MI / EV type (a.c. part) .....sine wave test current

MI / EV type (d.c. part) .....smooth DC current

**12.5.2 RCD  $U_c$  – Contact voltage**

Measuring range according to EN 61557 is 20.0 V ... 31.0 V for limit contact voltage 25 V

Measuring range according to EN 61557 is 20.0 V ... 62.0 V for limit contact voltage 50 V

 **$U_c$  – Contact voltage,  $U_c(P)$  – Contact voltage, external probe**

Measuring range (V)	Resolution (V)	Accuracy
0.0 ... 19.9	0.1	(-0 % / +15 %) of reading ± 10 digits
20.0 ... 99.9	0.1	(-0 % / +15 %) of reading

The accuracy is valid if mains voltage is stable during the measurement and PE terminal is free of interfering voltages. Specified accuracy is valid for complete operating range.

Test current ..... max.  $0.5 \times I_{\Delta N}$

Limit contact voltage ( $U_c$ ,  $U_c(P)$ ) ..... 12 V, 25 V, 50 V

**12.5.3 RCD  $t$  – Trip-out time**

Complete measurement range corresponds to EN 61557 requirements.

Maximum measuring times set according to selected reference for RCD testing.

 **$t_{\Delta N}$  – Trip-out time**

Measuring range (ms)	Resolution (ms)	Accuracy
0.0 ... 40.0	0.1	±1 ms
0.0 ... max. time*	0.1	±3 ms

\* For max. time see normative references in chapter **4.6.8.1 RCD standard**. This specification applies to max. time >40 ms.

Test current .....  $\frac{1}{2} \times I_{\Delta N}$ ,  $I_{\Delta N}$ ,  $2 \times I_{\Delta N}$ ,  $5 \times I_{\Delta N}$

$5 \times I_{\Delta N}$  is not available for  $I_{\Delta N} = 1000$  mA (RCD type AC) or  $I_{\Delta N} \geq 300$  mA (RCD types A, F, B, B+).

$2 \times I_{\Delta N}$  is not available for  $I_{\Delta N} = 1000$  mA (RCD types A, F) or  $I_{\Delta N} \geq 300$  mA (RCD types B, B+).

$1 \times I_{\Delta N}$  is not available for  $I_{\Delta N} = 1000$  mA (RCD types B, B+).

Specified accuracy is valid for complete operating range.

### 12.5.4 RCD I – Trip-out current

Complete measurement range corresponds to EN 61557 requirements.

#### $I_{\Delta}$ – Trip-out current

Measuring range	Resolution $I_{\Delta}$	Accuracy
$0.2 \times I_{\Delta N} \dots 1.1 \times I_{\Delta N}$ (AC type, MI / EV a.c. types)	$0.05 \times I_{\Delta N}$	$\pm 0.1 \times I_{\Delta N}$
$0.2 \times I_{\Delta N} \dots 1.5 \times I_{\Delta N}$ (A type, $I_{\Delta N} \geq 30$ mA)	$0.05 \times I_{\Delta N}$	$\pm 0.1 \times I_{\Delta N}$
$0.2 \times I_{\Delta N} \dots 2.2 \times I_{\Delta N}$ (A type, $I_{\Delta N} < 30$ mA)	$0.05 \times I_{\Delta N}$	$\pm 0.1 \times I_{\Delta N}$
$0.2 \times I_{\Delta N} \dots 2.2 \times I_{\Delta N}$ (B type, MI / EV d.c. types)	$0.05 \times I_{\Delta N}$	$\pm 0.1 \times I_{\Delta N}$

#### $t_{\Delta}$ – Trip out-time

Measuring range (ms)	Resolution (ms)	Accuracy
0 ... 300	1	$\pm 3$ ms

#### $U_c, U_c I_{\Delta}$ – Contact voltage

Measuring range (V)	Resolution (V)	Accuracy
0.0 ... 19.9	0.1	(-0 % / +15 %) of reading $\pm$ 10 digits
20.0 ... 99.9	0.1	(-0 % / +15 %) of reading

Limit contact voltage ( $U_c, U_c I_{\Delta}$ )..... 12 V, 25 V, 50 V

The accuracy is valid if mains voltage is stable during the measurement and PE terminal is free of interfering voltages. Specified accuracy is valid for complete operating range.

Trip-out measurement is not available for  $I_{\Delta N}=1000$  mA (RCD types B, B+).

### 12.5.5 RCD Auto

For technical specification refer to chapter **12.5 RCD testing** for technical specification of individual RCD tests.

## 12.6 Z loop, Z loop 4W – Fault loop impedance and prospective fault current

### Z – Fault loop impedance

Measuring range according to EN 61557 is 0.12  $\Omega$  ... 9.99 k $\Omega$ .

Measuring range ( $\Omega$ )	Resolution ( $\Omega$ )	Accuracy
0.00 ... 9.99	0.01	$\pm(3\%$ of reading + 3 digits)
10.0 ... 99.9	0.1	
100 ... 999	1	$\pm 10\%$ of reading
1.00 k ... 9.99 k	10	

### Ipsc – Prospective fault current

Measuring range (A)	Resolution (A)	Accuracy
0.00 ... 9.99	0.01	Consider accuracy of fault loop resistance measurement
10.0 ... 99.9	0.1	
100 ... 999	1	
1.00 k ... 9.99 k	10	
10.0 k ... 23.0 k	100	

### Ulpe – Voltage

Measuring range (V)	Resolution (V)	Accuracy
0 ... 550	1	$\pm(2\%$ of reading + 2 digits)

### Uc(P) – Contact voltage at Ipsc, external probe

Measuring range (V)	Resolution (V)	Accuracy
0.0 ... 99.9	0.1	(-0 % / +15 %) of reading $\pm$ 0.02 $\Omega \times$ Ipsc

The accuracy is valid if mains voltage is stable during the measurement.

Test current (at 230 V) ..... 20 A (10 ms)

Nominal voltage range ..... 93 V ... 134 V (16 Hz ... 400 Hz)

185 V ... 266 V (16 Hz ... 400 Hz)

R and  $X_L$  values are indicative.

## 12.7 Zs rcd – Fault loop impedance and prospective fault current in system with RCD

### Z – Fault loop impedance

Measuring range according to EN 61557 is 0.46  $\Omega$  ... 9.99 k $\Omega$  for I test = standard and 0.48  $\Omega$  ... 9.99 k $\Omega$  for I test = low.

Measuring range ( $\Omega$ )	Resolution ( $\Omega$ )	Accuracy I test = standard	Accuracy I test = low
0.00 ... 9.99	0.01	$\pm(5\% \text{ of reading} + 10 \text{ digits})$	$\pm(5\% \text{ of reading} + 12 \text{ digits})$
10.0 ... 99.9	0.1		
100 ... 999	1	$\pm 10\% \text{ of reading}$	$\pm 10\% \text{ of reading}$
1.00 k ... 9.99 k	10		

Accuracy may be impaired in case of heavy noise on mains voltage.

### Ipsc – Prospective fault current

Measuring range (A)	Resolution (A)	Accuracy
0.00 ... 9.99	0.01	Consider accuracy of fault loop resistance measurement
10.0 ... 99.9	0.1	
100 ... 999	1	
1.00 k ... 9.99 k	10	
10.0 k ... 23.0 k	100	

### Uipe – Voltage

Measuring range (V)	Resolution (V)	Accuracy
0 ... 550	1	$\pm(2\% \text{ of reading} + 2 \text{ digits})$

### Uc(P) – Contact voltage at Ipsc (Protection = TN), external probe

Measuring range (V)	Resolution (V)	Accuracy
0.0 ... 99.9	0.1	$(-0\% / +15\%) \text{ of reading} \pm 0.02 \Omega \times I_{psc}$

### Uc(P) – Contact voltage at IAN (Protection = TT rcd), external probe

Measuring range (V)	Resolution (V)	Accuracy
0.0 ... 99.9	0.1	$(-0\% / +15\%) \text{ of reading} \pm 10 \text{ digits}$

### Uc – Contact voltage

Refer to chapter **12.5.2 RCD Uc – Contact voltage** for detailed technical specification.

Nominal voltage range.....93 V ... 134 V (16 Hz ... 400 Hz)  
185 V ... 266 V (16 Hz ... 400 Hz)

No trip out of RCD.

R, X<sub>L</sub> values are indicative.

## 12.8 Z loop m $\Omega$ – High precision fault loop impedance and prospective fault current

For technical specification refer to **A 1143 – Euro Z 290 A adapter Instruction manual**.

## 12.9 Z line, Z line 4W – Line impedance and prospective short-circuit current

### Z – Line impedance

Measuring range according to EN 61557 is 0.12  $\Omega$  ... 9.99 k $\Omega$ .

Measuring range ( $\Omega$ )	Resolution ( $\Omega$ )	Accuracy
0.00 ... 9.99	0.01	$\pm(3\%$ of reading + 3 digits)
10.0 ... 99.9	0.1	
100 ... 999	1	$\pm 10\%$ of reading
1.00 k ... 9.99 k	10	

### Ipsc – prospective short-circuit current

I<sub>max</sub> – Maximal single-phase prospective short-circuit current

I<sub>max2p</sub> – Maximal two-phases prospective short-circuit current

I<sub>max3p</sub> – Maximal three-phases prospective short-circuit current

Measuring range (A)	Resolution (A)	Accuracy
0.00 ... 0.99	0.01	Consider accuracy of line resistance measurement
1.0 ... 99.9	0.1	
100 ... 999	1	
1.00 k ... 99.99 k	10	
100 k ... 199 k	1000	

### U<sub>ln</sub> – Voltage

Measuring range (V)	Resolution (V)	Accuracy
0 ... 550	1	$\pm(2\%$ of reading + 2 digits)

Test current (at 230 V) ..... 20 A (10 ms)

Nominal voltage range ..... 93 V ... 134 V (16 Hz ... 400 Hz)

185 V ... 266 V (16 Hz ... 400 Hz)

321 V ... 485 V (16 Hz ... 400 Hz)

R, X<sub>L</sub>, I<sub>min</sub>, I<sub>min2p</sub>, I<sub>min3p</sub> values are indicative.

## 12.10 Voltage Drop

### $\Delta U$ – Voltage drop

Measuring range (%)	Resolution (%)	Accuracy
0.0 ... 99.9	0.1	Consider accuracy of line impedance measurement(s)*

### U<sub>ln</sub>, I<sub>p</sub>sc, Z<sub>ref</sub>, Z

Refer to chapter **12.9 Z line, Z line 4W – Line impedance and prospective short-circuit current** for technical specification.

Z<sub>REF</sub> measuring range ..... 0.00  $\Omega$  ... 20.0  $\Omega$

Test current (at 230 V) ..... 20 A (10 ms)

Nominal voltage range ..... 93 V ... 134 V (16 Hz ... 400 Hz)

185 V ... 266 V (16 Hz ... 400 Hz)

321 V ... 485 V (16 Hz ... 400 Hz)

\*See chapter **7.18 Voltage Drop** for more information about calculation of voltage drop result.

## 12.11 Z line mΩ – High precision line impedance and prospective fault current

For technical specification refer to *A 1143 – Euro Z 290 A adapter Instruction manual*.

## 12.12 Z auto, AUTO TT, AUTO TN, AUTO TN (RCD), AUTO IT

Refer to following chapters for detailed technical specification:

**12.5.2 RCD Uc – Contact voltage,**

**12.6 Z loop, Z loop 4W – Fault loop impedance and prospective fault current,**

**12.7 Zs rcd – Fault loop impedance and prospective fault current in system with RCD,**

**12.9 Z line, Z line 4W – Line impedance and prospective short-circuit current,**

**12.10 Voltage Drop,**

**12.13 Rpe – PE conductor resistance,**

**12.22 ISFL – First fault leakage current and**

**12.23 IMD.**

## 12.13 Rpe – PE conductor resistance

**RCD: No**

**R – PE conductor resistance**

Measuring range (Ω)	Resolution (Ω)	Accuracy
0.00 ... 19.99	0.01	±(5 % of reading + 5 digits)
20.0 ... 99.9	0.1	
100.0 ... 199.9	0.1	± 10 % of reading
200 ... 1999	1	

Measuring current.....min. 200 mA into PE resistance of 2 Ω

**RCD: Yes, no trip out of RCD**

**R – PE conductor resistance**

Measuring range (Ω)	Resolution (Ω)	Accuracy
0.00 ... 19.99	0.01	±(5 % of reading + 10 digits)
20.0 ... 99.9	0.1	
100.0 ... 199.9	0.1	± 10 % of reading
200 ... 1999	1	

Accuracy may be impaired in case of heavy noise on mains voltage.

Measuring current..... < 15 mA

Nominal voltage range.....93 V ... 134 V (16 Hz ... 400 Hz)

185 V ... 266 V (16 Hz ... 400 Hz)



## 12.14 Earth – Earth resistance (3-wire measurement)

### Re – Earth resistance

Measuring range according to EN61557-5 is 0.20  $\Omega$  ... 1999  $\Omega$ .

Measuring range ( $\Omega$ )	Resolution ( $\Omega$ )	Accuracy
0.00 ... 19.99	0.01	$\pm(5\% \text{ of reading} + 5 \text{ digits})$
20.0 ... 199.9	0.1	
200 ... 9999	1	

Max. auxiliary earth electrode resistance  $R_C$  ..... 100 $\times R_E$  or 50 k $\Omega$  (whichever is lower)

Max. probe resistance  $R_P$  ..... 100 $\times R_E$  or 50 k $\Omega$  (whichever is lower)

$R_C$  and  $R_P$  values are indicative.

Additional probe resistance error at  $R_{Cmax}$  or  $R_{Pmax}$ .  $\pm(10\% \text{ of reading} + 10 \text{ digits})$

Additional error at 3 V voltage noise (50 Hz) .....  $\pm(5\% \text{ of reading} + 10 \text{ digits})$

Open circuit voltage ..... < 30 VAC

Short circuit current ..... < 30 mA

Test voltage frequency ..... 125 Hz

Test voltage shape ..... sine wave

Noise voltage indication threshold ..... 1 V (< 50  $\Omega$ , worst case)

Automatic measurement of auxiliary electrode resistance and probe resistance.

Automatic measurement of voltage noise.

## 12.15 Earth 2 clamp – Contactless earthing resistance measurement (with two current clamps)

### Re – Earth resistance

Measuring range ( $\Omega$ )	Resolution ( $\Omega$ )	Accuracy <sup>*)</sup>
0.00 ... 19.99	0.01	$\pm(10\% \text{ of reading} + 10 \text{ digits})$
20.0 ... 30.0	0.1	$\pm(20\% \text{ of reading})$
30.1 ... 39.9	0.1	$\pm(30\% \text{ of reading})$

<sup>\*)</sup> Distance between current clamps > 30 cm.

Additional error at 3 V voltage noise (50 Hz) .....  $\pm 10\% \text{ of reading}$

Test voltage frequency ..... 125 Hz

Noise current indication ..... yes

Low clamp current indication ..... yes

Additional clamp error has to be considered.

## 12.16 Ro – Specific earth resistance

### $\rho$ – Specific earth resistance

Measuring range ( $\Omega\text{m}$ )	Resolution ( $\Omega\text{m}$ )	Accuracy
0.0 ... 99.9	0.1	See accuracy note
100 ... 999	1	
1.00 k ... 9.99 k	0.01 k	
10.0 k ... 99.9 k	0.1 k	
100 k ... 9999 k	1 k	

### $\rho$ – Specific earth resistance

Measuring range ( $\Omega\text{ft}$ )	Resolution ( $\Omega\text{ft}$ )	Accuracy
0.0 ... 99.9	0.1	See accuracy note
100 ... 999	1	
1.00 k ... 9.99 k	0.01 k	
10.0 k ... 99.9 k	0.1 k	
100 k ... 9999 k	1 k	

$R_C$  and  $R_P$  values are indicative.

Principle:

$$\rho = 2 \cdot \pi \cdot d \cdot R_e,$$

where  $R_e$  is a measured resistance in 4-wire method and  $d$  is distance between the probes.

#### Accuracy note:

Accuracy of the specific earth resistance result depends on measured earth resistance  $R_e$  as follows:

#### $R_e$ – Earth resistance

Measuring range ( $\Omega$ )	Accuracy
1.00 ... 1999	$\pm 5\%$ of measured value
2000 ... 19.99 k	$\pm 10\%$ of measured value
>20 k	$\pm 20\%$ of measured value

Additional error:

See *Earth resistance three-wire method*.

## 12.17 Voltage, frequency, and phase rotation

### 12.17.1 Phase rotation

Nominal system voltage range..... 100 V<sub>AC</sub> ... 550 V<sub>AC</sub>  
 Nominal frequency range..... 14 Hz ... 500 Hz  
 Result displayed ..... 1.2.3 or 3.2.1

### 12.17.2 Voltage / Online terminal voltage monitor

Measuring range (V)	Resolution (V)	Accuracy
0 ... 550	1	±(2 % of reading + 2 digits)

Result type ..... True r.m.s. (TRMS)  
 Nominal frequency range..... 0 Hz, 14 Hz ... 500 Hz

### 12.17.3 Frequency

Measuring range (Hz)	Resolution (Hz)	Accuracy
0.00 ... 9.99	0.01	±(0.2 % of reading + 1 digit)
10.0 ... 499.9	0.1	

Nominal voltage range..... 20 V ... 550 V

## 12.18 Varistor test

### Udc – DC voltage

Measuring range (V)	Resolution (V)	Accuracy
0 ... 2500	1	$\pm(3\% \text{ of reading} + 3 \text{ digits})$

### Uac – AC voltage

Measuring range (V)	Resolution (V)	Accuracy
0 ... 1562	1	Consider accuracy of DC voltage

Measurement principle ..... d.c. voltage ramp

Test voltage slope ..... Nominal test voltage 1000 V: 100 V/s

Nominal test voltage 2500 V: 350 V/s

Threshold current ..... 1 mA

## 12.19 Currents

Maximum voltage on C1 measuring input .....3 V

Nominal frequency.....0 Hz, 40 Hz ... 500 Hz

**Ch1 clamp type: A1018**

**Range: 20 A**

**I1 – Current**

Measuring range (A)	Resolution (A)	Accuracy*
0.0 m ... 99.9 m	0.1 m	$\pm(5\% \text{ of reading} + 5 \text{ digits})$
100 m ... 999 m	1 m	$\pm(3\% \text{ of reading} + 3 \text{ digits})$
1.00 ... 19.99	0.01	$\pm(3\% \text{ of reading})$

**Ch1 clamp type: A1019**

**Range: 20 A**

**I1 – Current**

Measuring range (A)	Resolution (A)	Accuracy*
0.0 m ... 99.9 m	0.1 m	indicative
100 m ... 999 m	1 m	$\pm(5\% \text{ of reading})$
1.00 ... 19.99	0.01	$\pm(3\% \text{ of reading})$

**Ch1 clamp type: A1391**

**Range: 40 A**

**I1 – Current**

Measuring range (A)	Resolution (A)	Accuracy*
0.00 ... 1.99	0.01	$\pm(3\% \text{ of reading} + 3 \text{ digits})$
2.00 ... 19.99	0.01	$\pm(3\% \text{ of reading})$
20.0 ... 39.9	0.1	$\pm(3\% \text{ of reading})$

**Ch1 clamp type: A1391**

**Range: 300 A**

**I1 – Current**

Measuring range (A)	Resolution (A)	Accuracy*
0.00 ... 19.99	0.01	indicative
20.0 ... 39.9	0.1	
40.0 ... 299.9	0.1	$\pm(3\% \text{ of reading} + 5 \text{ digits})$

\* Accuracy at operating conditions for instrument and current clamp is given.

## 12.20 Power

### Measurement characteristics

Function symbols	Class according to IEC 61557-12	Measuring range
P – Active power	2.5	5 % ... 100 % $I_{Nom}^{*)}$
S – Apparent power	2.5	5 % ... 100 % $I_{Nom}^{*)}$
Q – Reactive power	2.5	5 % ... 100 % $I_{Nom}^{*)}$
PF – Power factor	1	- 1 ... 1
THDu	2.5	0 % ... 20 % $U_{Nom}$

<sup>\*)</sup>  $I_{Nom}$  depends on selected current clamp type and selected range as follows:

A 1018: [20 A]

A1019: [20 A]

A 1391: [40 A, 300 A]

Function	Measuring range
<b>Power (P, S, Q)</b>	0.00 W (VA, Var) ... 99.9 kW (kVA, kVar)
<b>Power factor</b>	-1.00 ... 1.00
<b>Voltage THD</b>	0.1 % ... 99.9 %

Error of external voltage and current transducers is not considered in this specification.

## 12.21 Harmonics

### Measurement characteristics

Function symbols	Class according to IEC 61557-12	Measuring range
Uh	2.5	0 % ... 20 % $U_{Nom}$
THDu	2.5	0 % ... 20 % $U_{Nom}$
Ih	2.5	0 % ... 100 % $I_{Nom}^{*)}$
THDi	2.5	0 % ... 100 % $I_{Nom}^{*)}$

<sup>\*)</sup>  $I_{Nom}$  depends on selected current clamp type and selected range as follows:

A 1018: [20 A]

A1019: [20 A]

A 1391: [40 A, 300 A]

Function	Measuring range
<b>Voltage harmonics</b>	0.1 V ... 500 V
<b>Voltage THD</b>	0.1 % ... 99.9 %
<b>Current harmonics and Current THD</b>	0.00 A ... 199.9 A

Error of external voltage and current transducers is not considered in this specification.

## 12.22 ISFL – First fault leakage current

### Isc1, Isc2 – First fault leakage current

Measuring range (mA)	Resolution (mA)	Accuracy
0.0 ... 19.9	0.1	±(5 % of reading + 3 digits)

Measuring resistance..... approx. 390 Ω

Nominal voltage ranges ..... 93 V ≤ U<sub>L1-L2</sub> < 134 V

185 V ≤ U<sub>L1-L2</sub> ≤ 266 V

## 12.23 IMD

### R1, R2 – Threshold insulation resistance

R (kΩ)	Resolution (kΩ)	Note
5 ... 640	5	up to 128 steps

### I1, I2 – First fault leakage current at threshold insulation resistance

I (mA)	Resolution (mA)	Note
0.0 ... 19.9	0.1	calculated value <sup>*)</sup>

### t1, t2 – Activation / disconnection time of IMD

t1,t2 (s)	Resolution (s)	Accuracy
0.00 ... 19.99	0.01	± 0.01 s
20.0 ... 99.9	0.1	± 0.1 s

Nominal voltage ranges ..... 93 V ≤ U<sub>L1-L2</sub> ≤ 134 V

185 V ≤ U<sub>L1-L2</sub> ≤ 266 V

<sup>\*)</sup>See chapter 7.27 *IMD – Testing of insulation monitoring devices* for more information about calculation of first fault leakage current at threshold insulation resistance.

## 12.24 Illumination

### E – Illumination (A 1172)

Specified accuracy is valid for complete operating range.

Measuring range (lux)	Resolution (lux)	Accuracy
0.01 ... 19.99	0.01	±(5 % of reading + 2 digits)
20.0 ... 199.9	0.1	±(5 % of reading)
200 ... 1999	1	
2.00 k ... 19.99 k	10	

Measurement principle .....silicon photodiode with V(λ) filter

Spectral response error .....< 3.8 % according to CIE curve

Cosine error.....< 2.5 % up to an incident angle of ± 85°

Overall accuracy.....matched to DIN 5032 class B standard

**E – Illumination (A 1173)**

Specified accuracy is valid for complete operating range.

Measuring range (lux)	Resolution (lux)	Accuracy
0.01 ... 19.99	0.01	±(10 % of reading + 3 digits)
20.0 ... 199.9	0.1	±(10 % of reading)
200 ... 1999	1	
2.00 k ... 19.99 k	10	

Measurement principle .....silicon photodiode

Cosine error.....&lt; 2.5 % up to an incident angle of ± 85°

Overall accuracy.....matched to DIN 5032 class C standard

**12.25 Discharging time****t – Discharging time**

Measuring range according to EN 61557-14 is 0.8 s ... 9.9 s.

Range (s)	Resolution (s)	Accuracy
0.0 s ... 9.9	0.1	±(5 % of reading + 2 digits)

**Up – Peak voltage**

Range (V)	Resolution (V)	Accuracy
0 ... 550	1	±(5 % of reading + 3 digits)

High limits.....1 s, 5 s

Threshold voltage .....34 V, 60 V, 120 V

Input resistance .....20 MΩ

**12.26 Auto Sequences®**

Refer to each individual test (measurement) for detailed technical specification.

**12.27 General data**

Power supply .....	Li-Ion battery pack 7.2 V, 4400 mAh (type: 18650T22A2S2P) 8800 mAh (type: 18650T22A2S4P) optional
Operation.....	Typical 16 h (type: 18650T22A2S2P) Typical 32 h (type: 18650T22A2S4P)
Charger socket input voltage .....	12 V ± 10 %
Charger socket input current.....	3000 mA max.
Battery charging current .....	up to 2200 mA (Battery type: 18650T22A2S2P) up to 3000 mA (Battery type: 18650T22A2S4P)
Measuring category .....	600 V CAT III 300 V CAT IV
Protection classification .....	double insulation
Pollution degree.....	2
Protection degree .....	56 (with protective covers on USB, Charger and PS/2 terminals)



Display ..... 4.3 inch (10.9 cm) 480x272 pixels TFT colour display  
with touch screen

Dimensions (w × h × d) ..... 252 mm × 111 mm × 165 mm

Weight ..... 1.78 kg, with battery pack (type: 18650T22A2S2P)

#### Reference conditions

Reference temperature range ..... 10 °C ... 30 °C

Reference humidity range ..... 40 %RH ... 70 %RH

#### Operation conditions

Working temperature range ..... 0 °C ... 40 °C

Maximum relative humidity ..... 95 %RH (0 °C ... 40 °C), non-condensing

#### Storage conditions

Temperature range ..... -10 °C ... +70 °C

Maximum relative humidity ..... 90 %RH (-10 °C ... +40 °C)

80 %RH (40 °C ... 60 °C)

#### Locator

Locator ..... supports inductive mode

Maximum operation voltage ..... 440 V a.c.

#### Communication ports, memory

RS 232 ..... 115200 bits/s, 8N1 serial protocol

USB ..... USB 2.0 Hi speed interface

with USB type B receptacle connector

Data storage capacity ..... 8 GB SD memory card

Bluetooth module ..... Class 2

The error in operating conditions could be at most the error for reference conditions (specified in the manual for each function) +1 % of measured value + 1 digit, unless otherwise specified in the manual for particular function.

## Appendix A Profile notes

Instrument supports working with multiple Profiles. This appendix contains collection of minor modifications related to particular country requirements. Some of the modifications mean modified listed function characteristics related to main chapters and others are additional functions. Some minor modifications are related also to different requirements of the same market that are covered by various suppliers.

### A.1 Profile Austria (ATAF)

Testing special delayed G type RCD supported.

Modifications in chapter **7.9 Testing RCDs**.

Special delayed G type RCD selection added in the **Selectivity** parameter in **Test Parameters / Limits** section as follows:

---

**Selectivity**    **Characteristic** [--, S, G]

---

Time limits are the same as for general type RCD and contact voltage is calculated the same as for general type RCD.

Selective (time delayed) RCDs and RCDs with (G) - time delayed characteristic demonstrate delayed response characteristics. They contain residual current integrating mechanism for generation of delayed trip out. However, contact voltage pre-test in the measuring procedure also influences the RCD and it takes a period to recover into idle state. Time delay of 30 s is inserted before performing trip-out test to recover S type RCD after pre-tests and time delay of 5 s is inserted for the same purpose for G type RCD.

**Table 7.2: Relationship between  $U_c$ ,  $U_c(P)$  and  $I_{\Delta N}$**  changed as follows:

RCD type		Contact voltages $U_c$ and $U_c(P)$ proportional to	Rated $I_{\Delta N}$
AC, EV, MI (a.c. part)	--	$1.05 \times I_{\Delta N}$	any
	G		
AC	S	$2 \times 1.05 \times I_{\Delta N}$	$\geq 30$ mA
A, F	--	$1.4 \times 1.05 \times I_{\Delta N}$	
A, F	G		
A, F	S	$2 \times 1.4 \times 1.05 \times I_{\Delta N}$	
A, F	--	$2 \times 1.05 \times I_{\Delta N}$	< 30 mA
	G		
A, F	S	$2 \times 2 \times 1.05 \times I_{\Delta N}$	any
B, B+	--	$2 \times 1.05 \times I_{\Delta N}$	
B, B+	S	$2 \times 2 \times 1.05 \times I_{\Delta N}$	

Technical specifications unchanged.

## A.2 Profile Hungary (ATAG)

Fuse type gR added to the fuse tables. Refer to *Fuse tables guide* for detailed information on fuse data.

New Single test function **Visual Test** added.

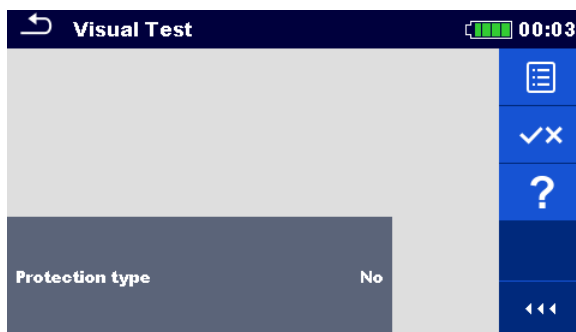



Figure A.1: Visual Test menu

### Measurement parameters / limits

<b>Protection type</b>	<b>Protection type</b> [No, Automatic disconnection, Class II, Electrical separation, SELV,PELV]
------------------------	--

### Measurement procedure

- › Enter the **Visual Test** function.
- › Set test parameters / limits.
- › Perform the visual inspection on tested object.
- › Use  to select PASS / FAIL / NO STATUS indication.
- › Save results (optional).

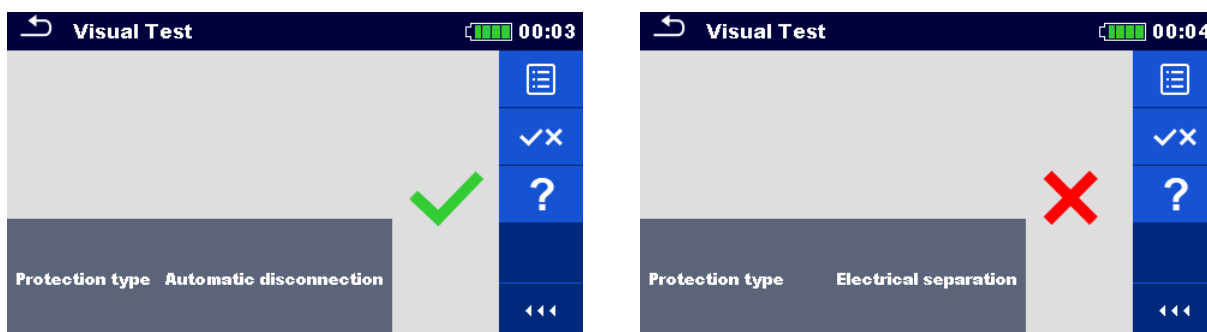

Figure A.2: Examples of Visual Test result

Modifications in chapter 7.10 *RCD Auto – RCD Auto test*

Added tests with multiplication factor 2.

**Modification of RCD Auto test procedure**

RCD Auto test inserted steps	Notes
<ul style="list-style-type: none"> <li>Re-activate RCD. Test with <math>2 \times I_{\Delta N}</math>, (+) positive polarity (new step 3).</li> </ul>	RCD should trip-out
<ul style="list-style-type: none"> <li>Re-activate RCD. Test with <math>2 \times I_{\Delta N}</math>, (-) negative polarity (new step 4).</li> </ul>	RCD should trip-out

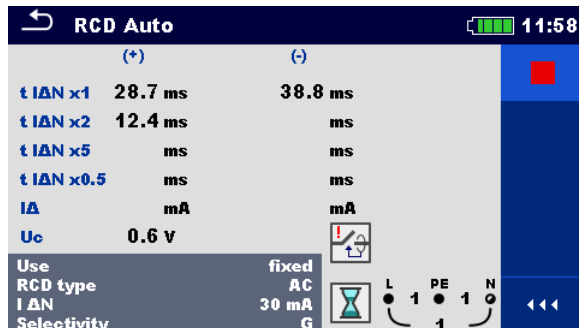

Inserted new Step 3

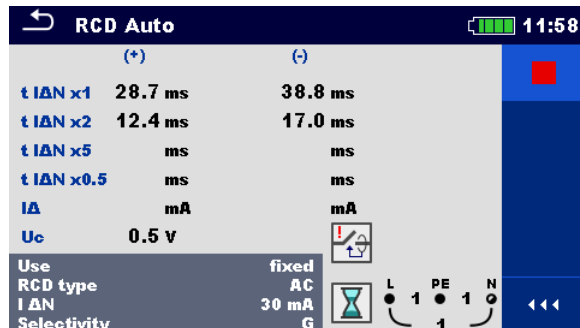

Inserted new Step 4

Figure A.3: Example of individual steps in RCD Auto test – Inserted 2 new steps

### Test results / sub-results

$t I_{\Delta N} \times 1 (+)$	Step 1 trip-out time ( $I_{\Delta} = I_{\Delta N}$ , (+) positive polarity)
$t I_{\Delta N} \times 1 (-)$	Step 2 trip-out time ( $I_{\Delta} = I_{\Delta N}$ , (-) negative polarity)
$t I_{\Delta N} \times 2 (+)$	Step 3 trip-out time ( $I_{\Delta} = 2 \times I_{\Delta N}$ , (+) positive polarity)
$t I_{\Delta N} \times 2 (-)$	Step 4 trip-out time ( $I_{\Delta} = 2 \times I_{\Delta N}$ , (-) negative polarity)
$t I_{\Delta N} \times 5 (+)$	Step 5 trip-out time ( $I_{\Delta} = 5 \times I_{\Delta N}$ , (+) positive polarity)
$t I_{\Delta N} \times 5 (-)$	Step 6 trip-out time ( $I_{\Delta} = 5 \times I_{\Delta N}$ , (-) negative polarity)
$t I_{\Delta N} \times 0.5 (+)$	Step 7 trip-out time ( $I_{\Delta} = \frac{1}{2} \times I_{\Delta N}$ , (+) positive polarity)
$t I_{\Delta N} \times 0.5 (-)$	Step 8 trip-out time ( $I_{\Delta} = \frac{1}{2} \times I_{\Delta N}$ , (-) negative polarity)
$I_{\Delta} (+)$	Step 9 trip-out current ((+) positive polarity)
$I_{\Delta} (-)$	Step 10 trip-out current ((-) negative polarity)
$I_{\Delta} \text{ d.c. } (+)$	Step 11 trip-out current ((+) positive polarity) <sup>1)</sup>
$I_{\Delta} \text{ d.c. } (-)$	Step 12 trip-out current ((-) negative polarity) <sup>1)</sup>
$U_c$	Contact voltage for rated $I_{\Delta N}$

Steps 11 and 12 are performed if parameter Use is set to 'other' and Type to EV RCD or MI RCD.

## A.3 Profile Finland (ATAH)

$I_a(I_{psc})$  limit modified in fuse types gG, NV, B, C, D and K.  
Refer to **Fuse tables guide** for detailed information on fuse data.

## A.4 Profile France (ATAI)

Modifications in chapters:

**7.9 Testing RCDs;**

**7.13 Zs rcd – Fault loop impedance and prospective fault current in system with RCD;**

**7.19 Z auto - Auto test sequence for fast line and loop testing;**

**7.31 AUTO TT – Auto test sequence for TT earthing system.**

650 mA added in the I<sub>ΔN</sub> parameter in **Test Parameters / Limits** section as follows:

<b>I<sub>ΔN</sub></b>	<b>Rated RCD residual current sensitivity</b> [10 mA, 15 mA, 30 mA, 100 mA, 300 mA, 500 mA, 650 mA, 1000 mA]
-----------------------	--

Modifications in chapter **12.5 RCD testing**

Nominal residual current (A,AC) ..... 10 mA, 15 mA, 30 mA, 100 mA, 300 mA, 500 mA, 650 mA, 1000 mA

### RCD test current in relation to RCD type, nominal RCD current and multiplication factor

I <sub>ΔN</sub> (mA)	I <sub>ΔN</sub> × 1/2 (mA)			I <sub>ΔN</sub> × 1 (mA)			I <sub>ΔN</sub> × 2 (mA)			I <sub>ΔN</sub> × 5 (mA)			RCD I <sub>Δ</sub>		
	AC	A, F	B, B+	AC	A, F	B, B+	AC	A, F	B, B+	AC	A, F	B, B+	AC	A, F	B, B+
10	5	3.5	5	10	20	20	20	40	40	50	100	100	✓	✓	✓
15	7.5	5.3	7.5	15	30	30	30	60	60	75	150	150	✓	✓	✓
30	15	10.5	15	30	42	60	60	84	120	150	212	300	✓	✓	✓
100	50	35	50	100	141	200	200	282	400	500	707	1000	✓	✓	✓
300	150	105	150	300	424	600	600	848	×	1500	×	×	✓	✓	✓
500	250	175	250	500	707	1000	1000	1410	×	2500	×	×	✓	✓	✓
650	325	227.5	250	650	916.5	1300	1300	×	×	×	×	×	✓	✓	✓
1000	500	350	500	1000	1410	×	2000	×	×	×	×	×	✓	✓	×

× .....not applicable

✓ .....applicable

AC type.....sine wave test current

A, F types.....pulsed current

B, B+ types.....smooth DC current

Other technical specifications remain unchanged.

## A.5 Profile Switzerland (ATAJ)

Modifications in chapter **4.4.1 Terminal voltage monitor**

In the Terminal voltage monitor the positions of L and N indications are opposite to standard version.

Voltage monitor example:

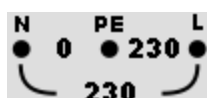

Online voltages are displayed together with test terminal indication. All three test terminals are used for selected measurement.

## Appendix B Commanders (A 1314, A 1401)

### B.1 ⚠ Warnings related to safety

#### Measuring category of commanders

Plug commander A 1314 ..... 300 V CAT II

Tip commander A 1401

(cap off, 18 mm tip) ..... 1000 V CAT II / 600 V CAT II / 300 V CAT II

(cap on, 4 mm tip) ..... 1000 V CAT II / 600 V CAT III / 300 V CAT IV

- Measuring category of commanders can be lower than protection category of the instrument.
- If dangerous voltage is detected on the tested PE terminal, immediately stop all measurements, find and remove the fault!
- When replacing battery cells or before opening the battery compartment cover, disconnect the measuring accessory from the instrument and installation.
- Service, repairs or adjustment of instruments and accessories is only allowed to be carried out by competent authorized personnel!

### B.2 Battery

The commander uses two AAA size alkaline or rechargeable Ni-MH battery cells. Nominal operating time is at least 40 h and is declared for cells with nominal capacity of 850 mAh.

#### Notes:

- If the commander is not used for a long period of time, remove all batteries from the battery compartment.
- Alkaline or rechargeable Ni-MH batteries (size AAA) can be used. Metrel recommends only using rechargeable batteries with a capacity of 800 mAh or above.
- Ensure that the battery cells are inserted correctly otherwise the commander will not operate and the batteries could be discharged.

### B.3 Description of commanders

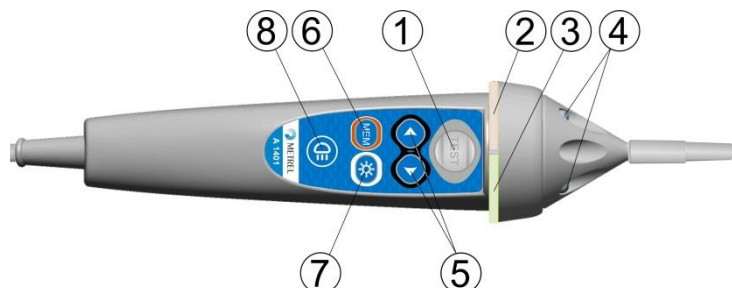

Figure B.1: Front side Tip commander (A 1401)

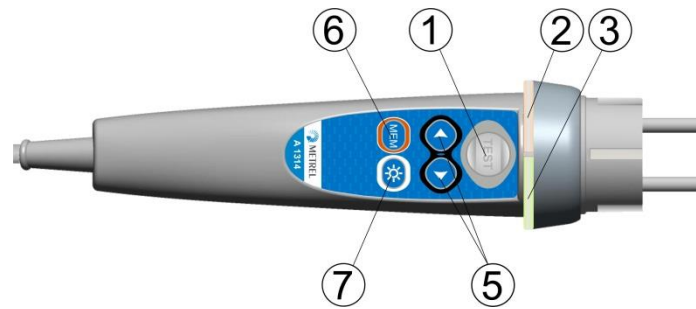

Figure B.2: Front side Plug commander (A 1314)

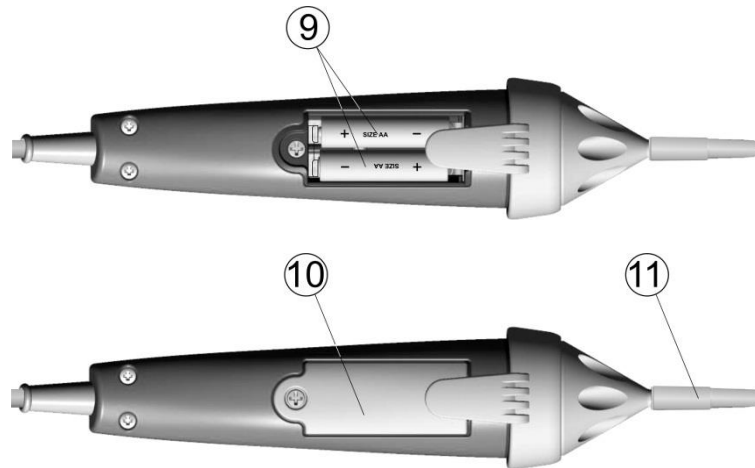

Figure B.3: Back side

1	TEST	TEST	Starts measurements. Acts also as the PE touching electrode.
2	LED	Left status	RGB LED
3	LED	Right status	RGB LED
4	LEDs	Lamp LEDs (Tip commander)	
5	Function selector	Selects test function.	
6	MEM	Store / recall / clear tests in memory of instrument.	
7	BL	Switches On / Off backlight on instrument	
8	Lamp key	Switches On / Off lamp (Tip commander)	
9	Battery cells	Size AAA, alkaline / rechargeable Ni-MH	
10	Battery cover	Battery compartment cover	
11	Cap	Removable CAT IV cap (Tip commander)	

## B.4 Operation of commanders

Both LED yellow	Warning! Dangerous voltage on the commander's PE terminal!
Right LED red	Fail indication
Right LED green	Pass indication
Left LED blinks blue	Commander is monitoring the input voltage.
Left LED orange	Voltage between any test terminals is higher than 50 V.
Both LEDs blink red	Low battery
Both LEDs red and switch off	Battery voltage too low for operation of commander

## Appendix C Locator receiver R10K

The highly sensitive hand-held **receiver R10K** detects the fields caused by the currents in the traced line. It generates sound and visual output according to the signal intensity. The operating mode switch in the head detector should always be set in IND (inductive) mode. The CAP (capacitive) operating mode is intended for operating in combination with other Metrel measuring equipment.

The built in field detector is placed in the front end of the receiver. External detectors can be connected via the rear connector.

Traced object must be energized when working with the EurotestXD.

Detectors	Operation
In built inductive sensor ( <b>IND</b> )	Tracing hidden wires.
Current clamp (optional)	Connected through the rear connector. Locating wires.
Selective probe	Connected through the rear connector. Locating fuses in fuse cabinets.

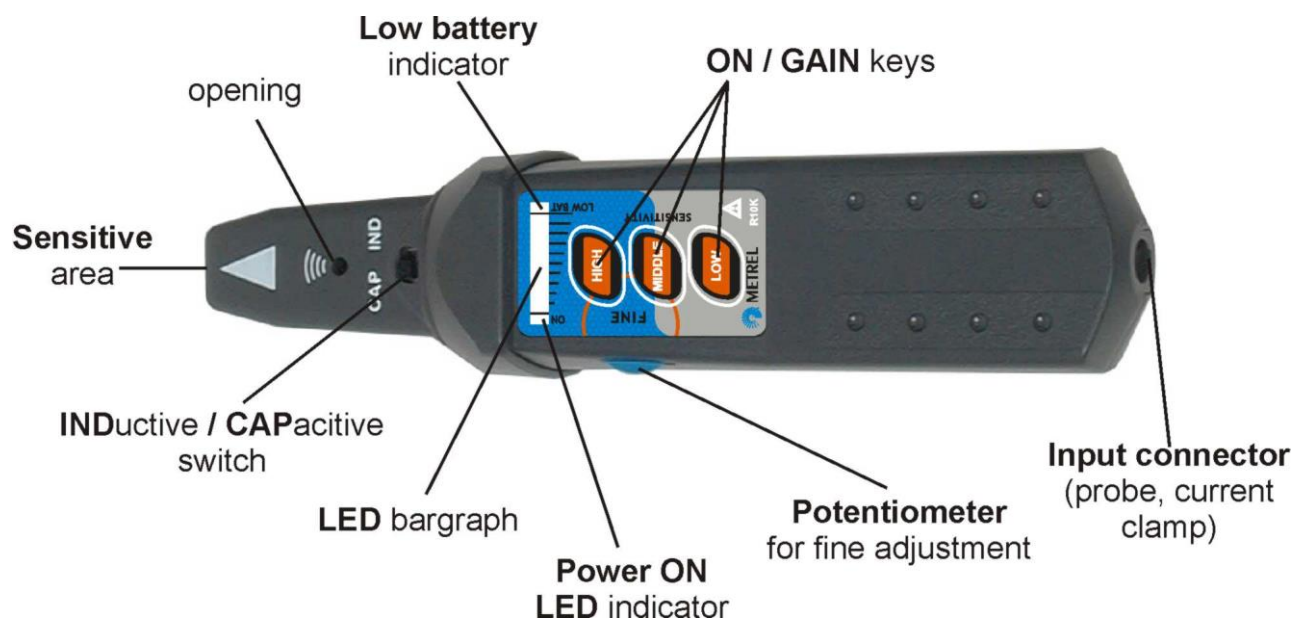

**Figure C.1: Receiver R10K**

The user can choose between three sensitivity levels (low, middle and high). An extra potentiometer is added for fine sensitivity adjustment. A buzzer sound and 10-level LED bar graph indicator indicates the strength of the magnetic field e.g. proximity of the traced object.



















**Note:**

- The field strength can vary during tracing. The sensitivity should always be adjusted to optimum for each individual tracing.









## Appendix D Structure objects

Structure elements used in Memory Organizer are instrument's Profile dependent.

Symbol	Default name	Description
	Node	Node
	Object	Object
	Dist. board	Distribution board
	Sub D. Board	Sub Distribution board
	Local bonding	Local equipotential bonding
	Water Service	Protective conductor for Water service
	Oil service	Protective conductor for Oil service
	Lightn. protect.	Protective conductor for Lightning protection
	Gas service	Protective conductor for Gas service
	Struct. steel	Protective conductor for Structural steel
	Other service	Protective conductor for Other incoming service
	Earthing cond.	Earthing conductor
	Circuit	Circuit
	Connection	Connection
	Socket	Socket
	Connection 3-ph	Connection - 3 phase
	Light	Light
	Socket 3-ph	Socket - 3 phase
	RCD	RCD
	MPE	MPE

Symbol	Default name	Description
	Foundation gr.	Protective conductor for Foundation ground
	Equip. bond. rail	Equipotential bonding rail
	House water m.	Protection conductor for House water meter
	Main water p.	Protection conductor for Main water pipes
	Main gr. cond.	Main grounding conductor
	Inter. gas inst.	Protective conductor for Interior gas installation
	Heat.inst.	Protective conductor for Heating installation
	Air cond. inst.	Protective conductor for Air conditioning installation
	Lift inst.	Protective conductor for Lift installation
	Data proc. Inst.	Protective conductor for Lift Data processing installation
	Teleph. Inst.	Protective conductor for Telephone installation
	Lighn. prot. syst.	Protective conductor for Lightning protection system
	Antenna inst.	Protective conductor for Antenna installation
	Build. Constr.	Protective conductor for Building construction
	Other conn.	Other connection
	Earth electrode	Earth electrode
	Lightning Sys.	Lightning System
	Lightning. electr.	Lightning electrode
	Inverter	Inverter
	String	String array
	Panel	Panel
	EVSE	Electro-Vehicle supply Equipment

Symbol	Default name	Description
	Level 1	Level 1
	Level 2	Level 2
	Level 3	Level 3
	Varistor	Varistor
	LS connection	LS connection
	Machine	Machine





## Appendix E Default list of Auto Sequences®

Default list of Auto Sequences® for MI 3155 – Eurotest XD instrument is available on Metrel home page [www.metrel.si](http://www.metrel.si).

# Appendix F Programming of Auto Sequences® on Metrel ES Manager

The Auto Sequence® editor is a part of the Metrel ES Manager software. In Auto Sequence® editor Auto Sequence® can be pre-programmed and organized in groups, before uploaded to the instrument.

## F.1 Auto Sequence® Editor workspace

To enter Auto Sequence® editor's workspace, select  in Home Tab of Metrel ES Manager PC SW. Auto Sequence® editor workspace is divided in four main areas. On the left side , structure of selected group of Auto Sequence® is displayed. In the middle part of the workspace , the elements of the selected Auto Sequence® are shown. On the right side, list of available Single tests (measurements and inspections)  and list of Flow commands  are shown.

Single test area contain three tabs: Measurements, Inspections and Custom Inspections tab. Custom Inspections and their tasks are programmed by user, see chapter **F.8 Custom Inspections programming** for procedure.

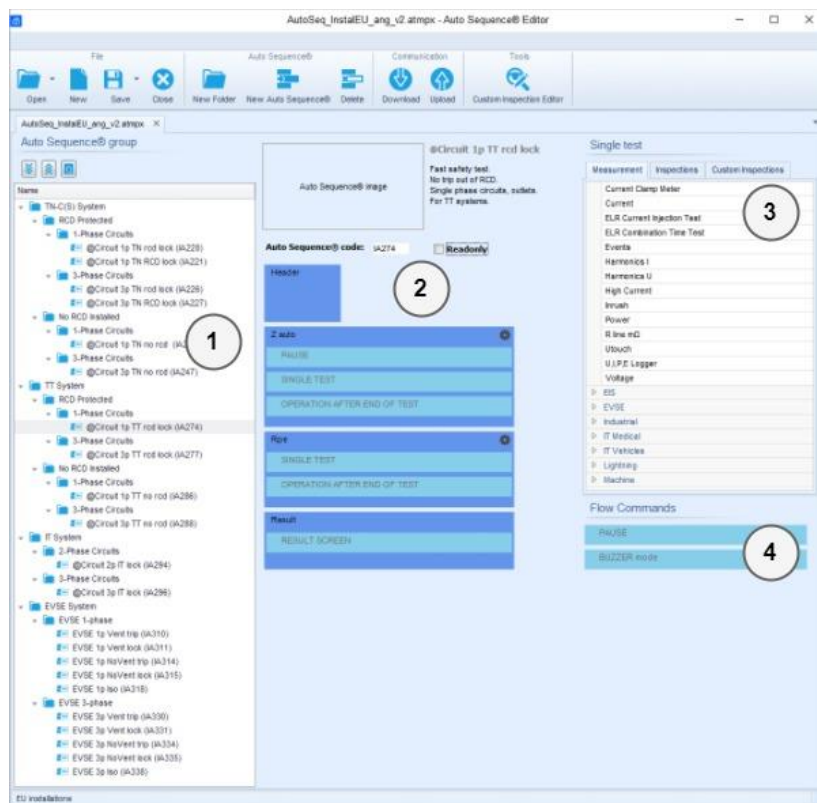

Figure F.1: Auto Sequence® Editor workspace

An Auto Sequence® <sup>2</sup> begins with Name, Description and Image, followed by the first step (Header), one or more measuring steps and ends with the last step (Result). By inserting appropriate Single tests (measurements and inspections) <sup>3</sup> and Flow commands <sup>4</sup> and setting their parameters, arbitrary Auto Sequences® can be created.

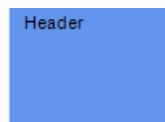

Figure F.2: Example of an empty Auto Sequence® header

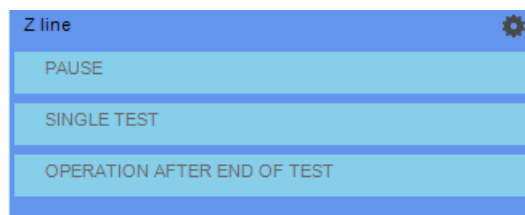

Figure F.3: Example of a measurement step



Figure F.4: Example of an Auto Sequence® result

## F.2 Managing groups of Auto Sequences®

The Auto Sequences® can be divided into different user defined groups of Auto Sequences®. Each group of Auto Sequences® is stored in a file. More files can be opened simultaneously in Auto Sequence® editor.

Within Group of Auto Sequences®, tree structure can be organized, with folders / subfolders containing Auto Sequences®. The three structure of currently active Group of Auto Sequences® is displayed on the left side of the Auto Sequence® Editor workspace, see **Figure F.5**.

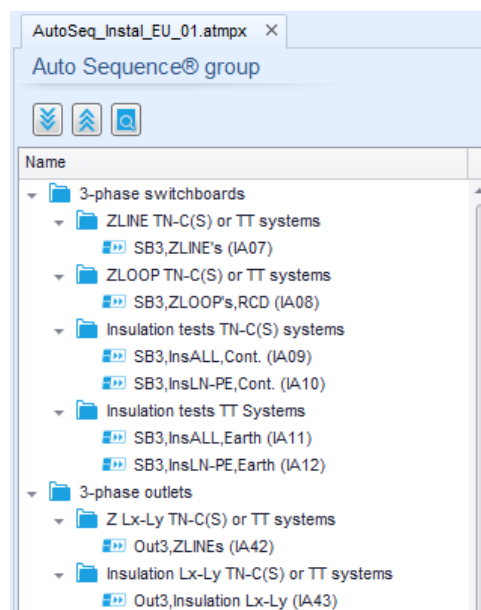

Figure F.5: Group of Auto Sequences® tree organization

Operation options on Group of Auto Sequences® are available from menu bar at the top of Auto Sequence® Editor workspace.

File operation options:



Opens a file (Group of Auto Sequences®).



Creates a new file (Group of Auto Sequences®).



Saves / Saves as the opened Group of Auto sequences® to a file.



Closes the file (Group of Auto Sequences®).

Group of Auto Sequences® view options:



Expand all folders / subfolders / Auto Sequences®.



Collapse all folders / subfolders / Auto Sequences®.



Toggle between Search by name within Auto Sequence® group and normal view. See chapter **F.4 Search within selected Auto Sequence® group** for details.

Group of Auto Sequences® operation options (also available by right clicking on Folder or Auto Sequence®):



Adds a new folder / subfolder to the group



Adds a new Auto Sequence® to the group.



Deletes:

- the selected Auto Sequence®
- the selected folder with all subfolders and Auto Sequences®

Right click on the selected Auto Sequence® or Folder opens menu with additional possibilities:



**Auto Sequence®:** Edit Name, Description and Image (see **Figure F.6.**)

**Folder:** Edit folder name



**Auto Sequence®:** Copy to clipboard

**Folder:** Copy to clipboard including subfolders and Auto Sequences®





**Auto Sequence®:** Paste it to selected location

**Folder:** Paste it to selected location



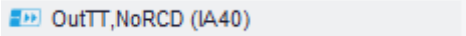

**Auto Sequence®:** Creates shortcut to selected Auto Sequence®

Double click on the object name allows it name edit:

DOUBLE CLICK	<p><b>Auto Sequence® name:</b> Edit Auto Sequence® name</p> <p></p> <p><b>Folder name:</b> Edit folder name</p> <p></p>
--------------	--

Drag and drop of the selected Auto Sequence® or Folder / Subfolder moves it to a new location:

DRAG & DROP	<p>'Drag and drop' functionality is equivalent to 'cut' and 'paste' in a single move.</p> <p> move to folder</p> <p> insert</p>
-------------	---



### F.3 Auto Sequence® Name, Description and Image editing

When EDIT function is selected on Auto Sequence®, menu for editing presented on **Figure F.6** appear on the screen. Editing options are:

**Name:** Edit or change the name of Auto Sequence®.

**Description:** Any text for additional description of Auto Sequence® can be entered.

**Image:** Image presenting Auto sequence® measuring arrangement can be entered or deleted.



Enters menu for browsing to Image location.



Deletes the Image from Auto Sequence®.

---

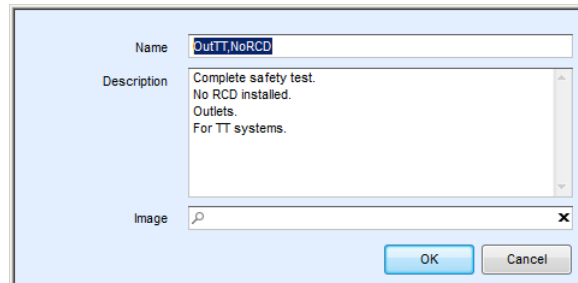

**Figure F.6: Editing the Auto Sequence® Name, Description and Image**

## F.4 Search within selected Auto Sequence® group

When  function is selected, Search menu as presented on **Figure F.7** appear on the screen. By entering the text into search box, found results are automatically highlighted with yellow background. Search functionality is implemented in Folders, Subfolders and Auto Sequences® of selected Auto Sequence® Group. Search text can be cleared by selecting the Clear button.

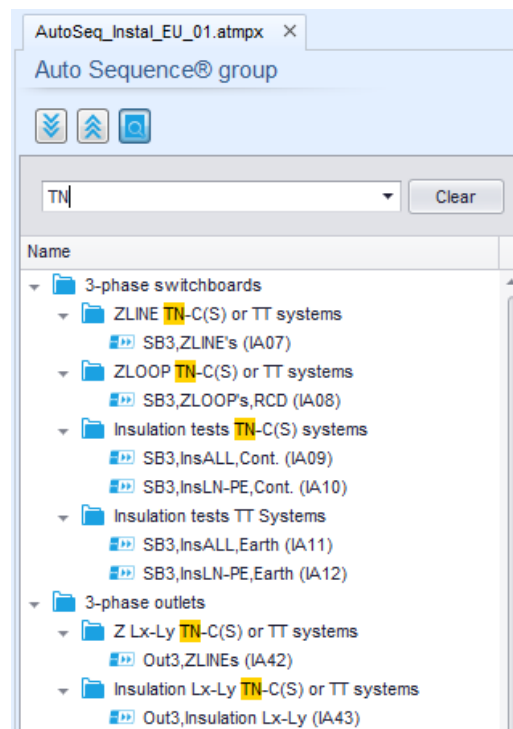

**Figure F.7: Example of Search result within Auto Sequence® group**

## F.5 Elements of an Auto Sequence®

### F.5.1 Auto Sequence® steps

There are three kinds of Auto Sequence® steps.

#### Header

The Header step is empty by default.

Flow commands can be added to the Header step.

#### Measurement step

The Measurement step contains a Single test and the Operation after end of test flow command by default. Other Flow commands can also be added to the Measurement step.

#### Result

The Result step contains the Result screen flow command by default. Other Flow commands can also be added to the Result step.

### F.5.2 Single tests

Single tests are the same as in Metrel ES Manager Measurement menu.

Limits and parameters of the measurements can be set. Results and sub-results can't be set.

### F.5.3 Flow commands

Flow commands are used to control the flow of measurements. Refer to chapter **F.7 Description of flow commands** for more information.





### F.5.4 Number of measurement steps

Often the same measurement step has to be performed on multiple points on the device under test. It is possible to set how many times a Measurement step will be repeated. All carried out individual Single test results are stored in the Auto Sequence® result as if they were programmed as independent measuring steps.

## F.6 Creating / modifying an Auto Sequence®

If creating a new Auto Sequence® from scratch, the first step (Header) and the last step (Result) are offered by default. Measurement steps are inserted by the user.

### Options

Adding a measurement step	By double clicking on a Single test a new measurement step will appear as the last of measurement steps. It can also be dragged and dropped on the appropriate position in the Auto Sequence®.
Adding flow commands	Selected flow command can be dragged from the list of Flow Commands and dropped on the appropriate place in any Auto Sequence® step.
Changing position of flow command within measurement step	By a click on an element and use of  and  keys.
Viewing / changing parameters of flow commands or single tests.	By a double click on the element.
Setting number of measurement step repetitions.	By setting a number in the  field.
Touch pre-test disable / enable (not available in all functions)	By setting True / False in the  field. (Default value is False – Touch pre-test is enabled)

Right click on the selected measurement step / flow command:

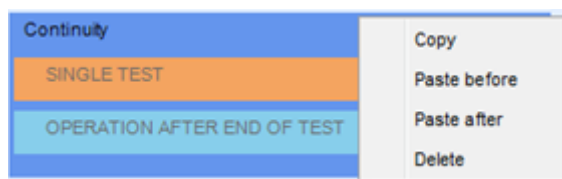

#### Copy – Paste before

A measurement step / flow command can be copied and pasted above selected location on the same or on another Auto Sequence®.

#### Copy – Paste after

A measurement step / flow command can be copied and pasted under selected location on the same or on another Auto Sequence®.

#### Delete

Deletes the selected measurement step / flow command.

## F.7 Description of flow commands

Double click on inserted Flow Command opens menu window, where text or picture can be entered, external commands can be activated and parameters can be set.

Flow commands Operation after end of test and Results screen are entered by default, others are user selectable from Flow Commands menu.

### Pause

A Pause command with text message or picture can be inserted anywhere in the measuring steps. Warning icon can be set alone or added to text message. Arbitrary text message can be entered in prepared field Text of menu window.

#### Parameters

---

Pause type    Show text and/or warning (  check to show warning icon).

                  Show picture (  browse for image path).

---

Duration        Number in seconds, infinite (no entry).

---

### Buzzer mode

Passed or failed measurement is indicated with beeps.

- Pass – double beep after the test
- Fail – long beep after the test

Beep happens right after single test measurement.

#### Parameters

---

State    On – enables Buzzer mode

          Off – disables Buzzer mode

---

**Operation after end of test**

This flow command controls the proceeding of the Auto Sequence® in regard to the measurement results.

**Parameters**

Operation after end of test	The operation can be individually set for the case the measurement passed, failed or ended without a status.
<ul style="list-style-type: none"> <li>· pass</li> <li>· fail</li> <li>· no status</li> </ul>	<p>Manual: The test sequence stops and waits for appropriate command (RUN key, external command ...) to proceed.</p> <p>Auto: The test sequence automatically proceeds.</p>

**Result screen**

This flow command controls the proceeding after the Auto Sequence® has ended.

**Parameters**

- Auto save Auto Sequence® results are stored in the momentary workspace.
- A new Node with the current month and year will be created. Under the Node Auto Sequence® results will be stored.
- Up to 100 Auto Sequence® results can be automatically stored under the same node. If more results are available, they are split to multiple nodes.
- Auto Save Flow setting is disabled by default.

**Note**

- This flow command is active only if Auto Sequence® is started from the Auto Sequence® Main menu (not from the Memory organizer).

## F.8 Custom Inspections programming

Arbitrary set of tasks dedicated to specific user defined Inspections can be programmed with application of Custom Inspection Editor Tool, accessible from Auto Sequence® Editor workspace. Custom Inspections are stored in dedicated file \*.indf with user defined name. For application of Custom Inspections as a single test within Auto Sequence® group, appropriate file containing specific Custom Inspection should be opened first.

### F.8.1 Creating and editing Custom Inspections

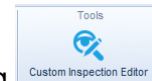

Custom Inspection Editor workspace is entered by selecting Custom Inspection Editor icon from Auto Sequences® main menu. It is divided in two main areas, as presented on **Figure 12.8**:

- 1 Custom Inspection **Name** and **Scope** of inspection (Visual or Functional)
- 2 **Name** of Custom Inspection Item tasks and **Type** of Item Pass / Fail checkbox marking

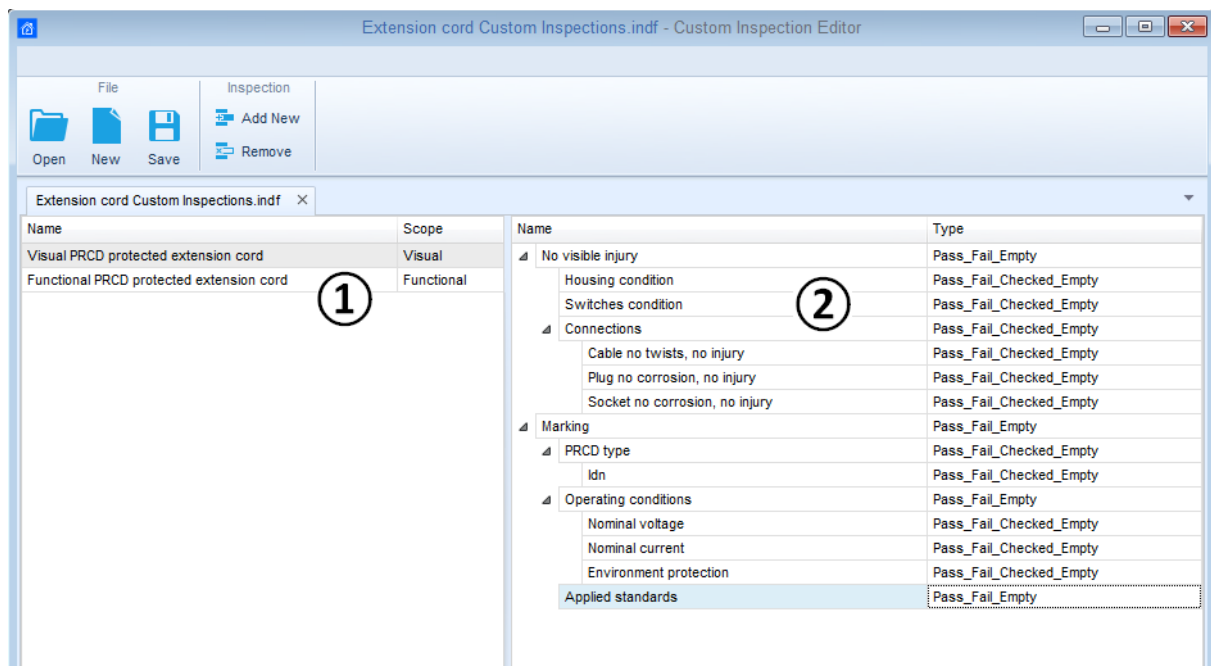

Figure 12.8: Custom Inspection Editor workspace

#### Custom Inspection Editor Main menu options:



Opens existing Custom Inspection Data file.

By selecting, menu for browsing to location of \*.indf file containing one or more Custom Inspections data appear on the screen. Selected file is opened in dedicated tab marked with file name.



Creates a new Custom Inspection Data file.

New tab with empty workspace is opened. Default name of the new tab is *Inspection Data File*; it could be renamed during Save procedure.

Saves / Saves as Custom Inspection Data file opened on active tab.



Menu for browsing to the folder location and editing of file name is opened. Browse to the location, confirm overwriting, if file already exists or edit file name to save it as a new Custom Inspection Data file.

Add New Custom Inspection.



New inspection with default name *Custom Inspection* and default scope *Visual* appear on the editor workspace. It contains one Item task with default name *Custom Inspection* and default Type *Pass\_Fail\_Checked\_Empty*. Default Name and Type can be edited – changed.

Remove selected custom inspection.



To select inspection, click to the inspection Name field. To remove it, select icon from editor main menu. Before removal, user is asked to confirm deletion.

## Edit Name and Scope of Inspection

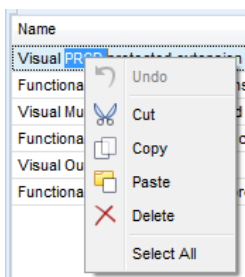

### Inspection Name edit:

Click to the Inspection Name field to start editing it. Drag cursor, with left mouse button pressed, to select letters and words. Position cursor and double-click to select word of the name. Actions could be performed with keyboard also. Press right mouse button to activate Edit menu and select appropriate action as presented on the left figure. Menu is case sensitive; options currently not available are greyed out.

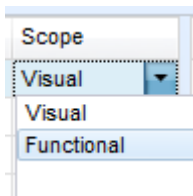

### Inspection Scope edit:

Click to Inspection Scope field to open selection menu presented on left figure. Options:  
**Visual** is intended for observation of test object  
**Functional** allows functional test of observed object

## Edit Item task structure of Inspection

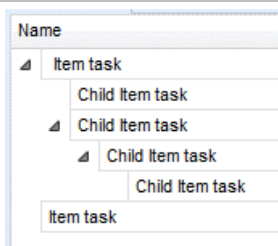

Item tasks of the selected Inspection are listed in Name column on the right side of Editor workspace.

Each Item task can have Child Item tasks, Child Item can have its own Child Item tasks and so on.

Arbitrary tree structure of Item tasks and subtasks can be built as presented on left figure.

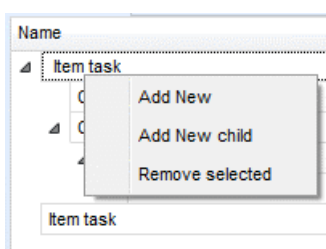

### ADD New Item task procedure:

Position cursor above Item task Name and apply right mouse click to select Item task and open menu with options:

**Add New:** new Item task is added on the top tree level

**Add New Child:** new child Item task is added under selected Item

**Remove selected:** delete selected Item task with all subtasks



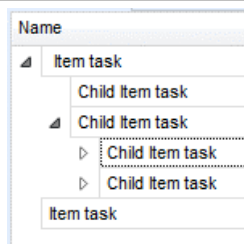

Default Name of New Item task is *Custom Inspection*, default Type *Pass\_Fail\_Checked\_Empty* and both can be edited – changed.



Item tasks containing Child Item tasks are marked with triangle in front of their Name.

Click on triangle mark:

-  collapse Item task tree structure
-  expands Item task tree structure

## Edit Name and Type of Item task

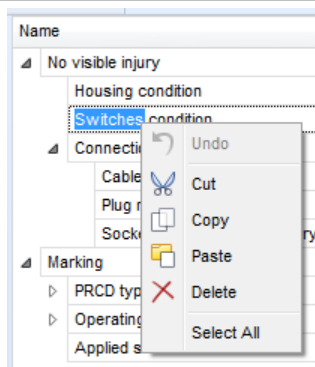

### Edit Name of Item task:

Click to the Item task Name field to start editing it.

Drag cursor, with left mouse button pressed, to select letters and words. Position cursor and double-click to select word of the name. Actions could be performed with keyboard also.

Press right mouse button to activate Edit menu and select appropriate action as presented on the left figure. Menu is case sensitive; options currently not available are greyed out.

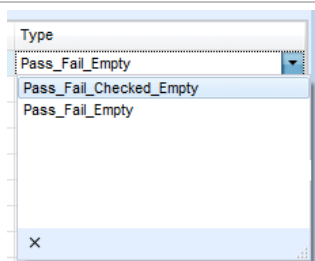

### Edit Type of Item task:

Click to Item Type field to open selection menu presented on left figure. Selectable checkbox status assignment options are:

**Pass\_Fail\_Checked\_Empty:** Pass, Fail, Checked, Empty (default)

**Pass\_Fail\_Empty:** Pass, Fail selection, Empty (default) value

## F.8.2 Applying Custom Inspections

Custom inspections can be applied in Auto Sequences®. Direct assignment of Custom inspection to the Metrel ES manager structure objects is not possible.

After custom created Inspection Data file is opened, available inspections are listed in Custom Inspections tab of Single test area of Auto Sequence® Editor, see chapter **F.1 Auto Sequence® Editor workspace** for details.

Custom Inspection is added to Auto sequence as a Single test, see chapter **F.6 Creating / modifying an Auto Sequence®** for details.

## Opening / changing Inspection Data File

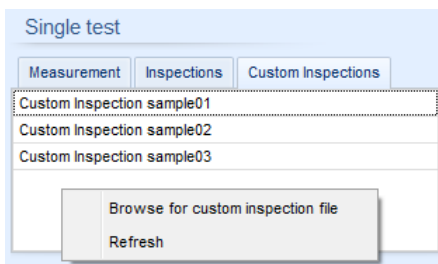

Position cursor within Custom inspections List area and apply mouse right click to open Option menu:

**Refresh:** Refresh content of already opened Inspection Data file

**Browse for custom Inspection file:**

Menu for browsing to folder location of new Inspection Data file is opened.

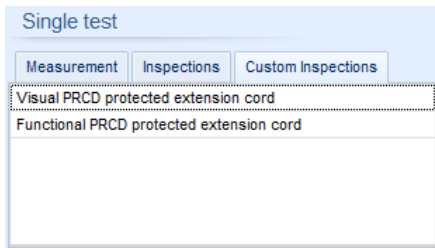

After confirmation of selection, new Inspection Data file is opened and list of available Custom Inspections is changed.

**Note:**

- › If Metrel ES Manager Work scope is changed, opened Inspection Data file remains active and available Custom Inspections remains the same.