

# RoofSupport PVbox

SMA.STP.15000-25000.T1.M



Conduct Technical Solutions BV  
Aalborg 4  
2993LP Barendrecht

Details:



RoofSupport PVbox

SMA.STP.15000-25000.CP.T1.M

Cover

Drawn by: S. Vanpraet

Date: 20-2-2019

Page

001

# INDEX

PAGE	DESCRIPTION	DRAWING TYPE	DRAWN BY	DATE
001	Cover	Title page / cover sheet	S. Vanpraet	20-2-2019
050	Index	Table of contents	S. Vanpraet	20-2-2019
100	Power supply	Schematic multi-line	S. Vanpraet	20-2-2019
101	Power supply	Schematic multi-line	S. Vanpraet	20-2-2019
600	Cabinet layout	Model view	S. Vanpraet	20-2-2019
601	Cabinet layout	Model view	S. Vanpraet	20-2-2019
700	Product list	Summarized parts list	S. Vanpraet	20-2-2019



RoofSupport PVbox

SMA.STP.15000-25000.CP.T1.M

Index

Drawn by: S. Vanpraet

Date: 20-2-2019

Page

050

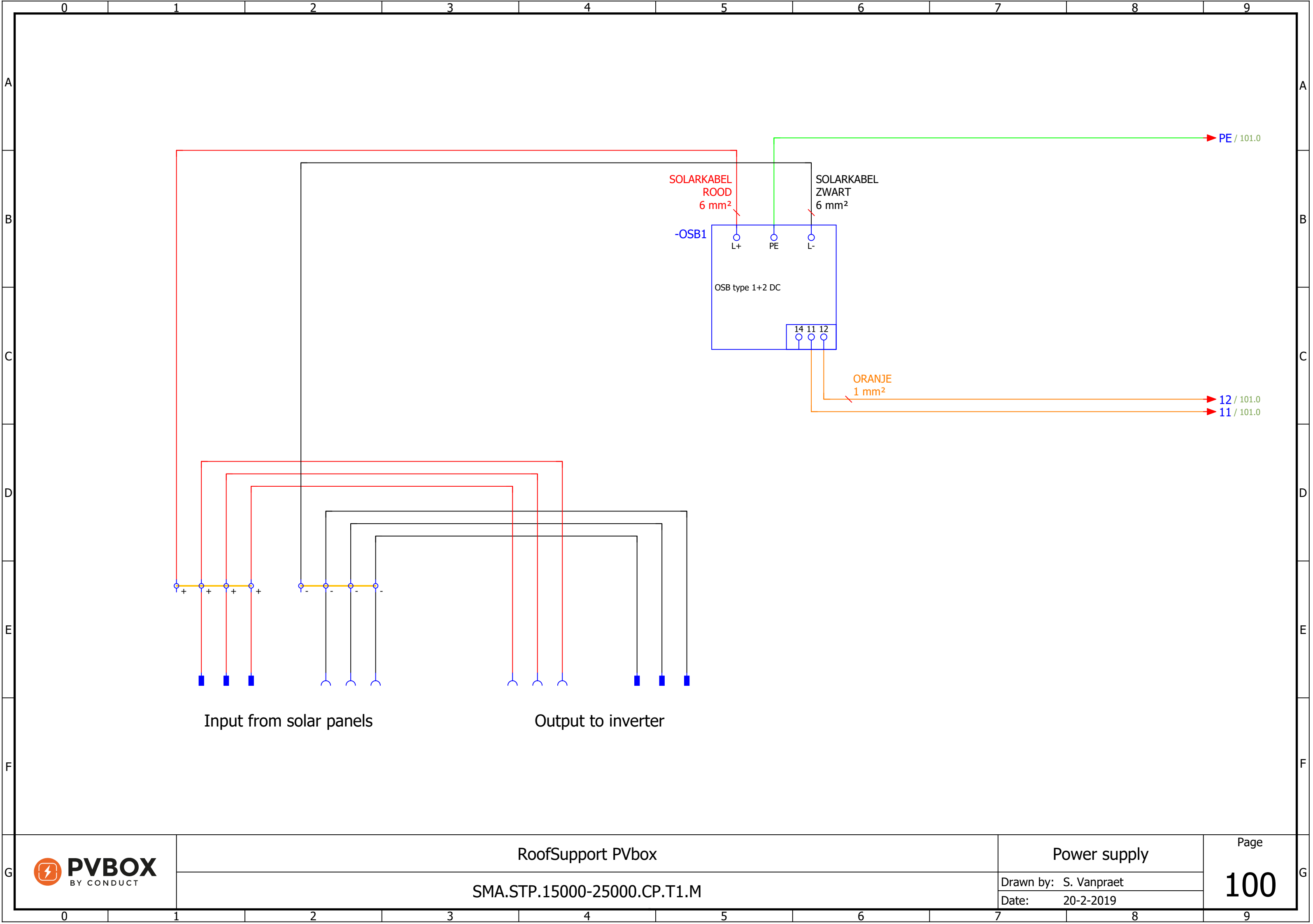

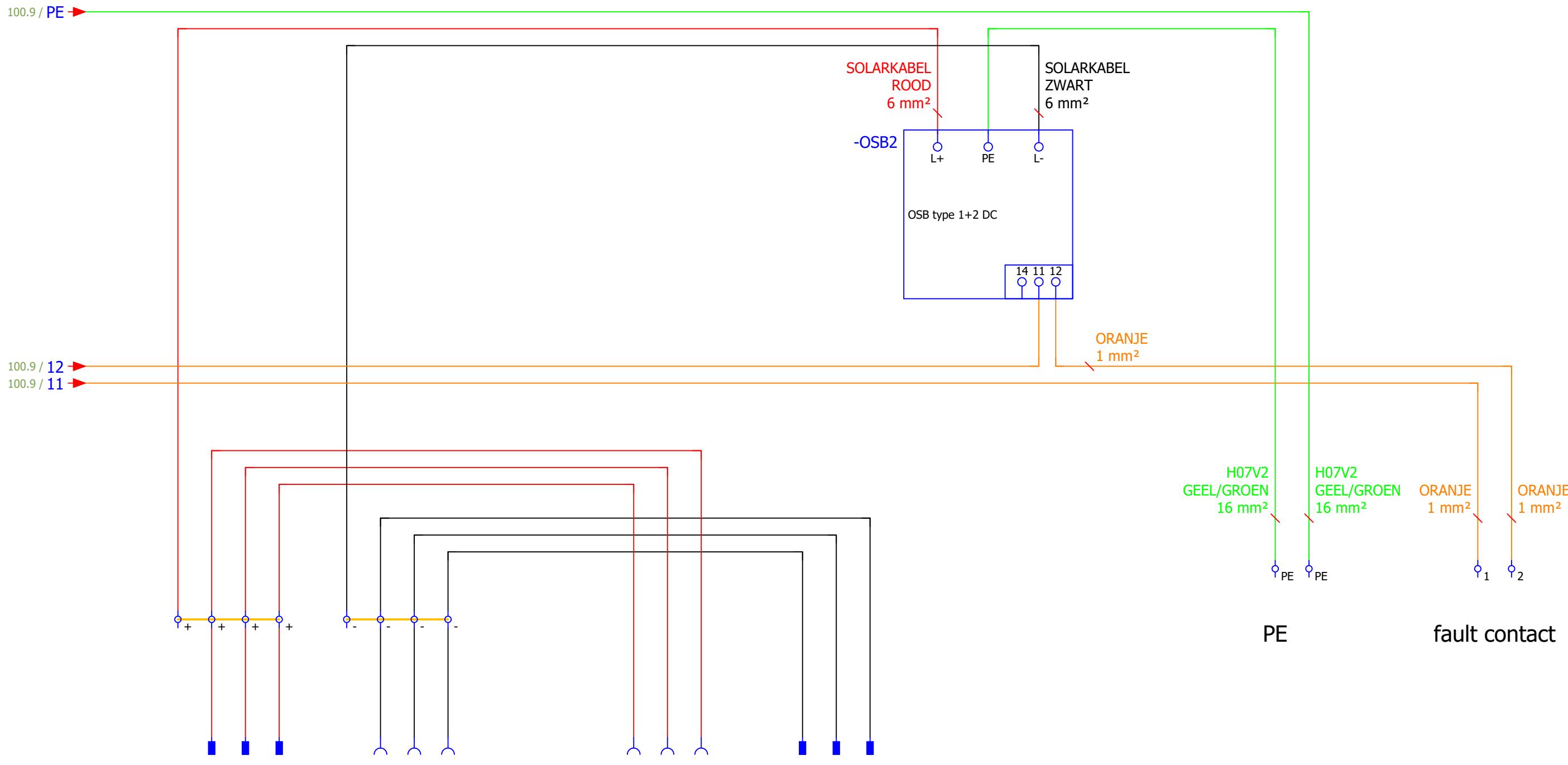

Input from solar panels

Output to inverter

PE

fault contact



RoofSupport PVbox  
SMA.STP.15000-25000.CP.T1.M

Power supply  
Drawn by: S. Vanpraet  
Date: 20-2-2019

Page  
**101**

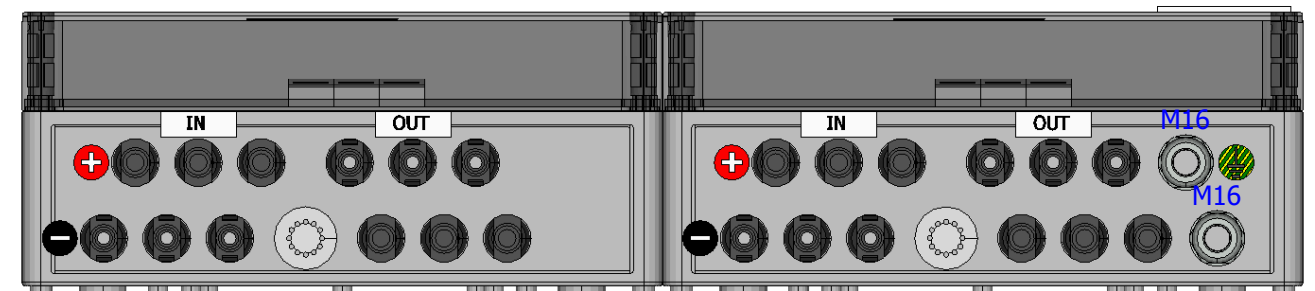
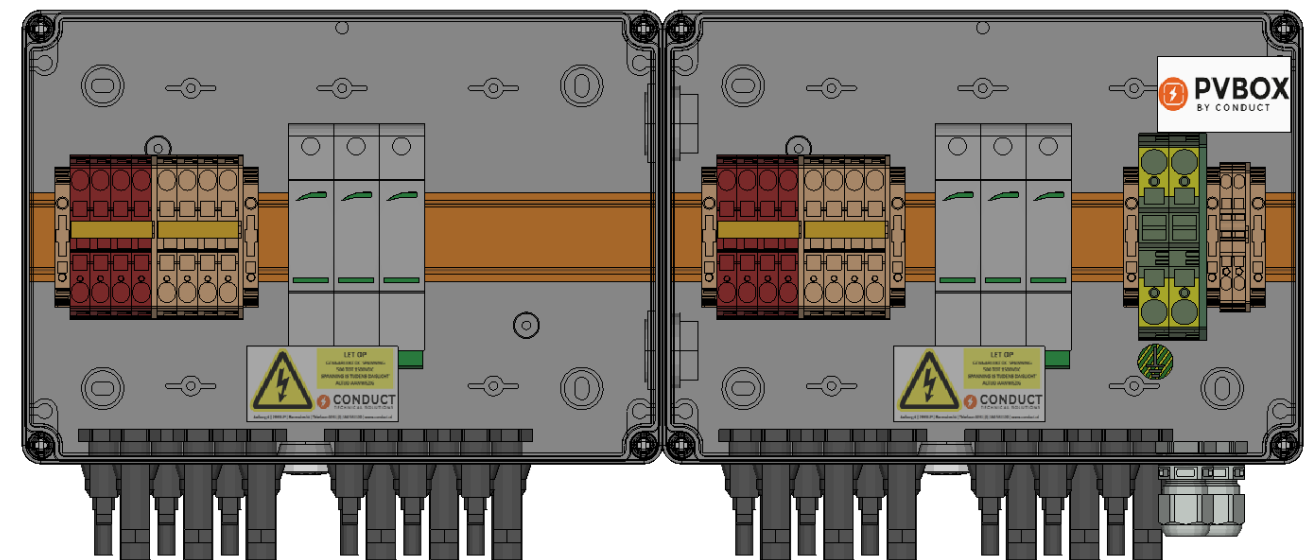
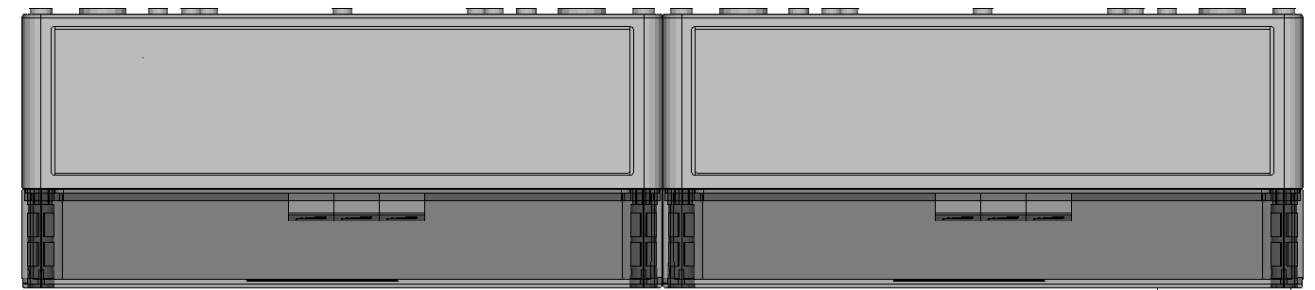
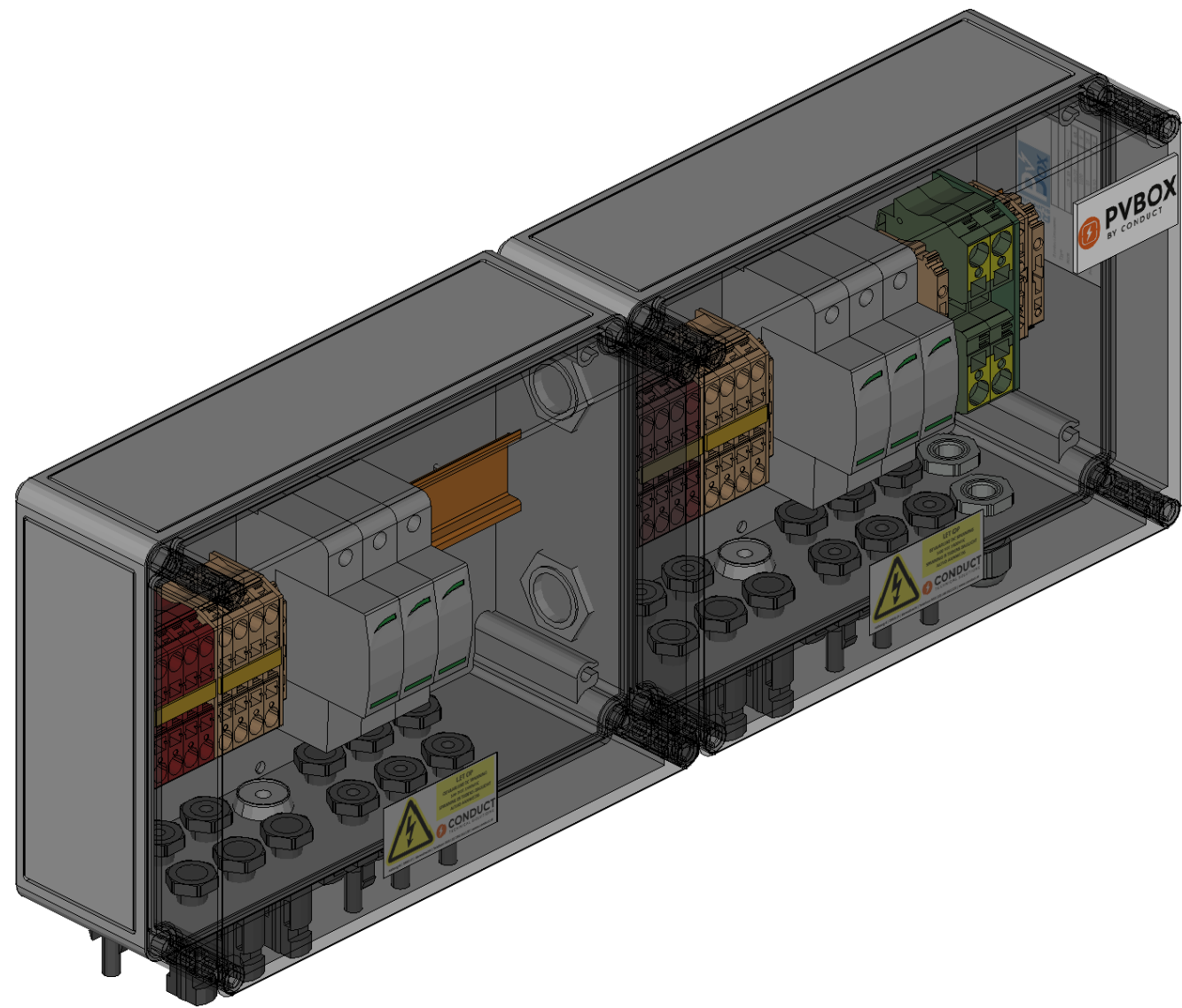

0	1	2	3	4	5	6	7	8	9
DEVICE CODE	DESCRIPTION			TYPE	PART NUMBER		MANUFACTURER		
OSB1	OSB Type 1-2 DC			PSC3-5/1000 PV IR	77738378		Cirprotec		
OSB2	OSB Type 1-2 DC			PSC3-5/1000 PV IR	77738378		Cirprotec		

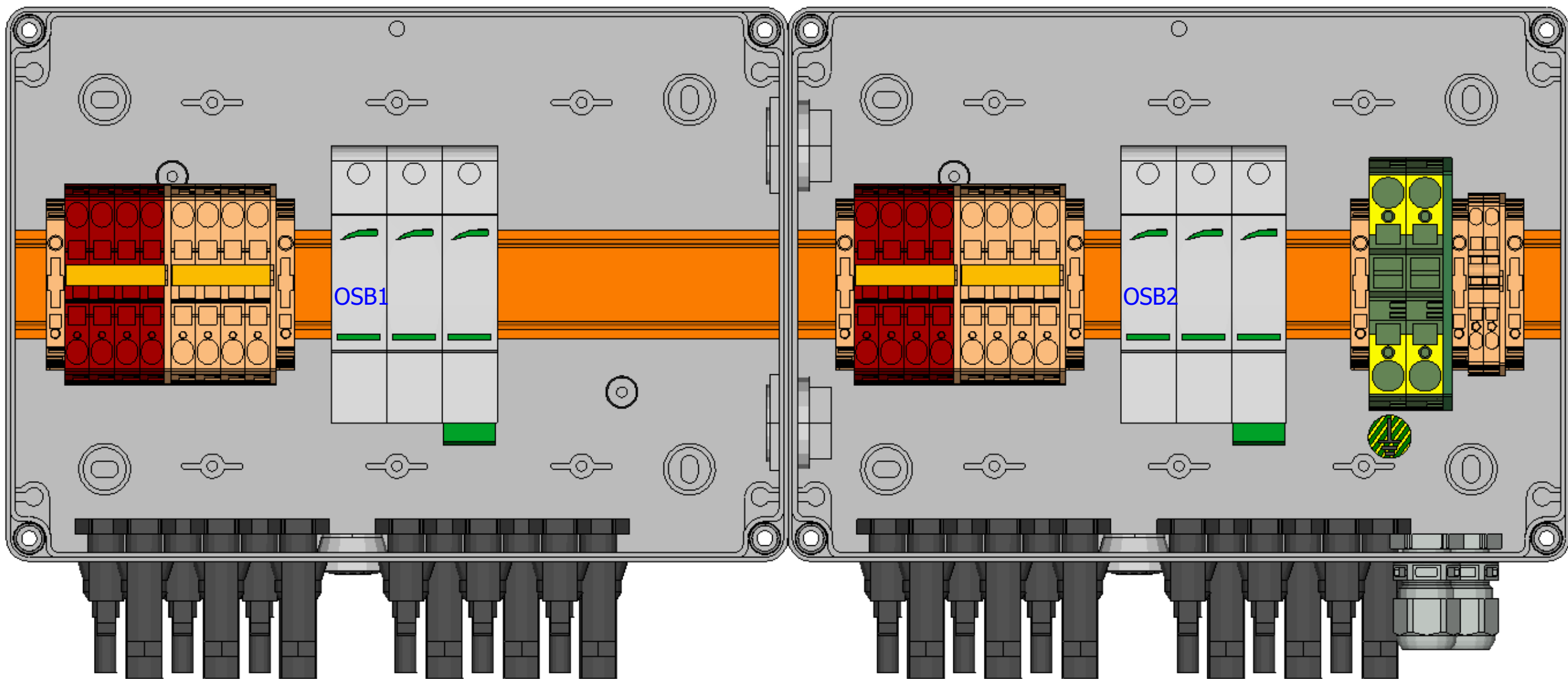

# PRODUCT LIST

Part list: SMA.STP.15000-25000.CP.T1.M Rev. 0

QUANTITY	DEVICE CODE	DESCRIPTION	TYPE	PART NUMBER	MANUFACTURER
0,496 m		Rail 35x7,5	TS 35_7,5		
2	OSB1;OSB2	OSB Type 1-2 DC	PSC3-5/1000 PV IR	77738378	Cirprotec
4		Jumper bar 4 connections	ZQI 6/4 YE	3765.8	Conta-Clip
7		End bracket	ZES 35/2	3811.2	Conta-Clip
8		Feed-through terminal block	ZRK6/2A rood	3581.9	Conta-Clip
4		End plate	ZAP6/2A beige	3760.2	Conta-Clip
8		Feed-through terminal block	ZRK6/2A Beige	3581.2	Conta-Clip
2		Feed-through terminal block	ZSL16/2A	3637.2	Conta-Clip
1		End plate	ZAP16/2A groen	3799.1	Conta-Clip
2		Feed-through terminal block	ZRK2,5/2A beige	3500.2	Conta-Clip
1		End plate	ZAP2,5/2A beige	3700.2	Conta-Clip
1		Sticker Type	Sticker	Sticker	GTV
2		Sticker "Let op: gevaarlijke DC spanning"	Sticker	Sticker	GTV
1		Sticker PVbox	Sticker	Sticker	GTV
12		Female connector solar MC4	PV-ADSP4-S2/6	32.0079P0001	Multicontact
12		Male connector solar MC4	PV-ADBP4-S2/6	32.0078P0001	Multicontact
2		TK PS 2518-11-to	TK PS 2518-11-to	11150801	Spelsberg
2		26242001	BST M20	26242001	Spelsberg
2		External fixing lugs	TK ABL	19400101	Spelsberg
2		19202501	KS M25	19202501	Spelsberg
2		Cable gland M16X1,5	ESKV16	10066411	Wiska
2		Gland locknut M16X1,5	EMUG16	10060771	Wiska

CNC: CP.2.NF.T1.NSX.6IN.6OUT.M  
Pos.: 27 - 28



RoofSupport PVbox

SMA.STP.15000-25000.CP.T1.M

Product list

Drawn by: S. Vanpraet

Date: 20-2-2019

Page

700